

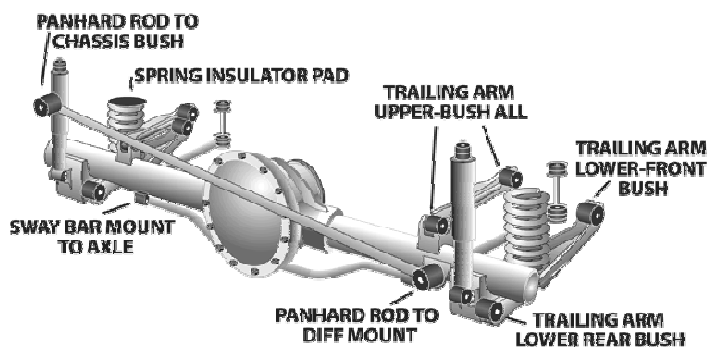

## CHRYSLER Centura KB - KC Sedan - 4/1975 - 4/1977

Página 1

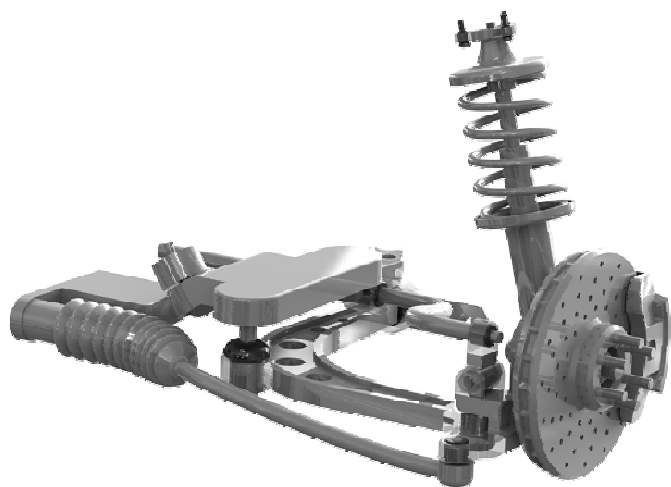



Aplicaci...	Descripción	Referencia	Kits por...	Contenido del Kit	
DEL.	Control Arm Lower-Inner Bushing	<b>MPU-0185K</b>	1	Bushings, Inner Tubes	
DEL.	Strut Bar To Chassis Mount Kit	<b>MPU-0327K</b>	1	Bushings	
DEL.	Strut Bar To Lower Control Arm Kit	<b>MPU-0591K</b>	1	Bushings, Inner Tubes	
DEL.	Sway Bar Link Bushing Kit	<b>MPU-2092K</b>	1	Bushings	
DEL.	Sway Bar Mount To Chassis Bushing Measure bar diameter 12mm to 30mm available	<b>MPU-1450-__K</b>	1	Bushings	
TRAS.	Trailing Arm Lower Front Bushing Re-use original shell	<b>MPU-0428K</b>	1	Inner Tubes, Bushings	
TRAS.	Panhard Rod To Diff Mount Bushing	<b>MPU-0078K</b>	1	Bushings	

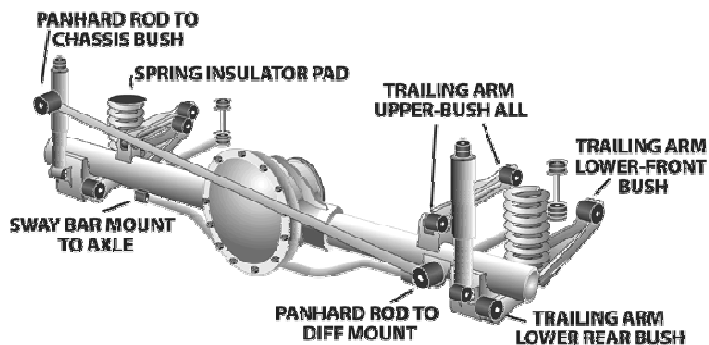
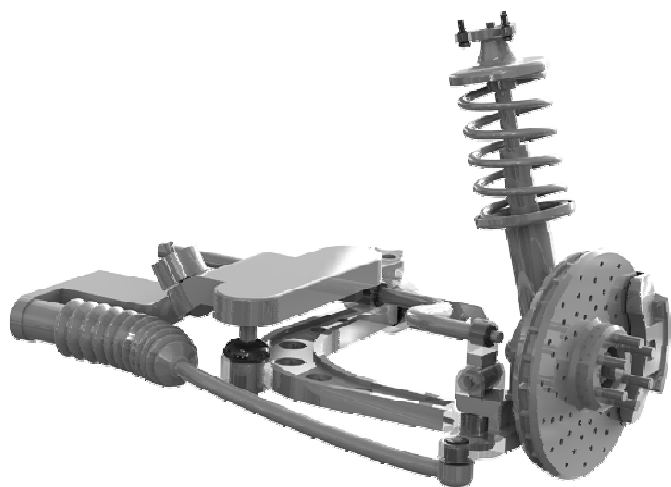

**CHRYSLER Centura KB - KC Sedan - 4/1975 - 4/1977**

Página 2 (Continúa)



Aplicaci...	Descripción	Referencia	Kits por...	Contenido del Kit	
TRAS.	Trailing Arm Lower Rear Bushing Re-use original shell	<b>MPU-0585K</b>	1	Inner Tubes, Bushings	 5 8 5 K
TRAS.	Trailing Arm Upper Bushing All Note	<b>MPU-0588K</b>	1	Inner Tubes, Bushings	 5 8 8 K



## CHRYSLER Valiant SV1 - CM - 1962 - 1981

Página 1

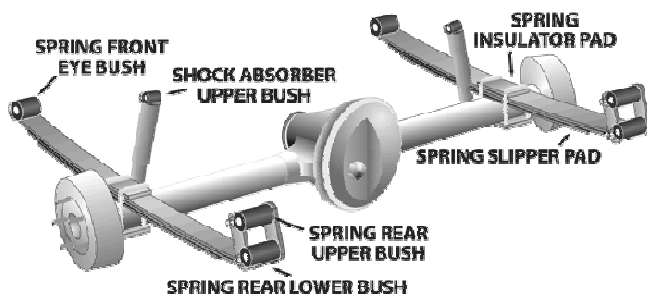
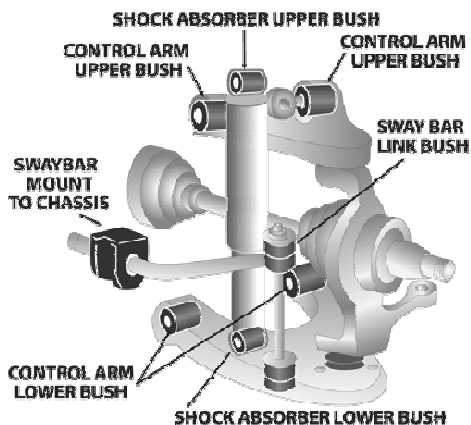







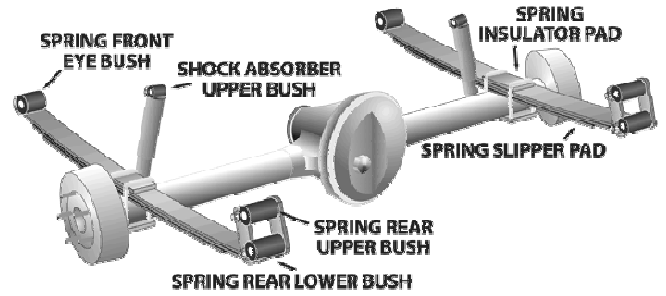
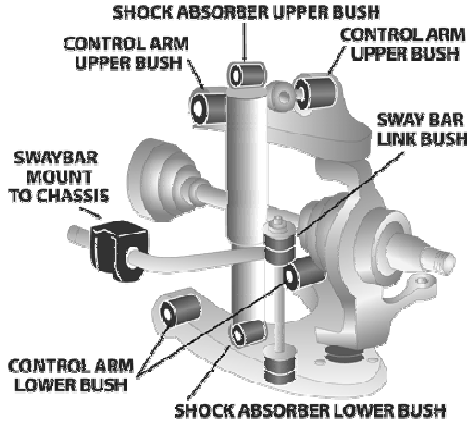

Aplicaci...	Descripción	Referencia	Kits por...	Contenido del Kit	
DEL.	Control Arm Lower-Inner Bushing SV1 to CM	<b>MPU-2170K</b>	1	Bushings, Inner Tubes, Outer Shells	
DEL.	Control Arm Upper-Inner Kit	<b>MPU-2081K</b>	1	Washers, Outer Shells, Inner Tubes, Bushings	
DEL.	Idler Arm Bushing SV1-VK After-market arm, tube ID 13mm,OD 29.7mm	<b>MPU-1665K</b>	1	Bushings, Inner Tubes	
DEL.	Idler Arm Bushing CL -CM After-market arm, tube ID 16mm,OD 29.7mm	<b>MPU-1666K</b>	1	Bushings, Inner Tubes	
DEL.	Idler Arm Bushing SV1-VK Original & TRW arms only,Tube ID 13mm,OD 28.6mm	<b>MPU-2067K</b>	1	Bushings, Inner Tubes, Outer Shells	
DEL.	Idler Arm Bushing CL-CM OE factory idler only,Tube ID 16mm,OD 28.6mm	<b>MPU-2068K</b>	1	Bushings, Inner Tubes, Outer Shells	
DEL.	Strut Bar To Chassis Mount Kit SV1 to VK	<b>MPU-0295K</b>	1	Bushings, Inner Tubes	



## CHRYSLER Valiant SV1 - CM - 1962 - 1981

Página 2 (Continúa)







Aplicaci...	Descripción	Referencia	Kits por...	Contenido del Kit	
DEL.	Strut Bar To Chassis Mount Kit CM, Chassis hole diameter 35mm	<b>MPU-0983K</b>	1	Inner Tubes, Bushings	
DEL.	Strut Bar To Chassis Mount Kit CL, chassis hole diameter 30mm	<b>MPU-1467K</b>	1	Inner Tubes, Bushings	
DEL.	Sway Bar Link Bushing Kit	<b>MPU-2092BK</b>	1	Bushings	
DEL.	Sway Bar Mount To Chassis Bushing Must purchase KBR19 bracket kit with this part	<b>MPU-1450-__K</b>	1	Bushings	
TRAS.	Spring Rear Lower Bushing CL to CM spring ID 34mm	<b>MPU-0289K</b>	1	Bushings	
TRAS.	Shock Absorber Bushing Upper & lower	<b>MPU-2628K</b>	1	Bushings	
TRAS.	Spring Front Eye Bushing 50mm ID spring eye	<b>MPU-0296K</b>	1	Inner Tubes, Bushings	

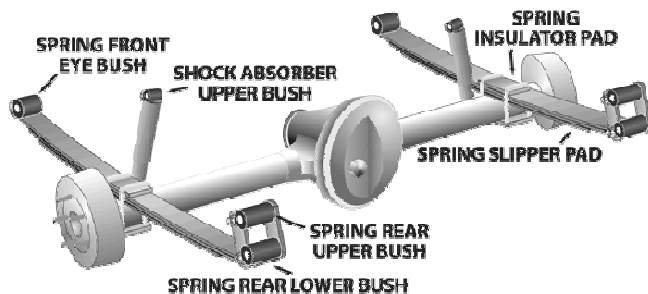
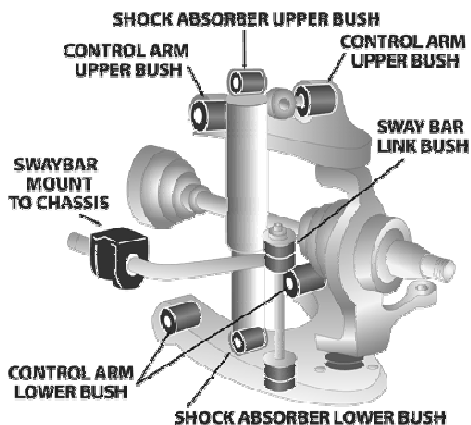

## CHRYSLER Valiant SV1 - CM - 1962 - 1981

Página 3 (Continúa)









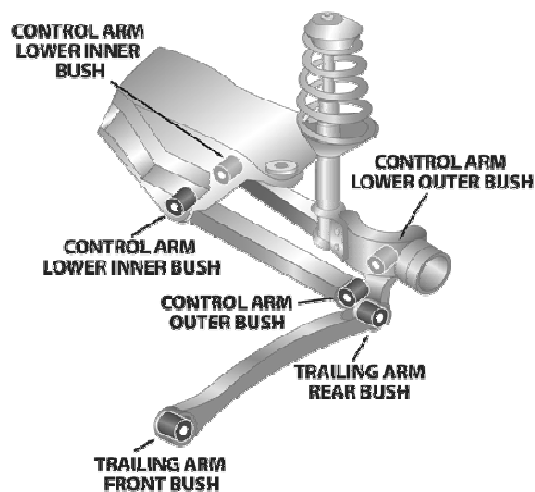
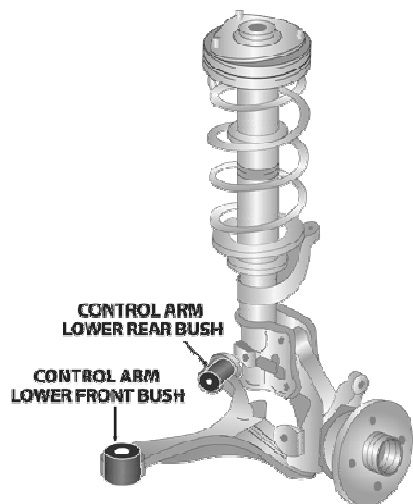

Aplicaci...	Descripción	Referencia	Kits por...	Contenido del Kit	
TRAS.	Spring Front Eye Bushing 35mm ID spring eye	<b>MPU-2210K</b>	1	Bushings, Inner Tubes	
TRAS.	Spring Rear Bushing All SV1 to VK with spring ID of 22mm	<b>MPU-2211K</b>	2	Bushings	
TRAS.	Spring Shackle Upper Bushing CL to CM	<b>MPU-2211K</b>	1	Bushings	



## CHRYSLER PT Cruiser Wagon - 8/2000 - 2009

Página 1





Aplicaci...	Descripción	Referencia	Kits por...	Contenido del Kit	
DEL.	Control Arm Lower-Inner Front Kit	<b>MPU-3341K</b>	1	Inner Tubes, Bushings	
DEL.	Control Arm Lower-Inner Rear Eccentric 1 x Offset & 1 x Standard for caster adjustment	<b>MPU-3343K</b>	1	Inst Sheet, Outer Shells, Inner Tubes, Bushings	
DEL.	Control Arm Lower-Inner Rear Eccentric 2 x Offset for caster adjustment	<b>MPU-3344K</b>	1	Inst Sheet, Outer Shells, Inner Tubes, Bushings	
DEL.	Control Arm Lower-Inner Rear Kit Standard replacement of OE# 19144158	<b>MPU-3342K</b>	1	Inst Sheet, Outer Shells, Inner Tubes, Bushings	
DEL.	Sway Bar Mount To Chassis Bushing Measure bar diameter, 22,27mm available	<b>MPU-2271-__K</b>	1	Bushings	
TRAS.	Sway Bar Link Bushing Kit Upper & lower	<b>MPU-2272K</b>	1	Bushings, Inner Tubes, Washers	
TRAS.	Sway Bar Mount to Beam Axle Bushing Measure bar diameter, 17,19mm available	<b>MPU-2273-__K</b>	1	Bushings	

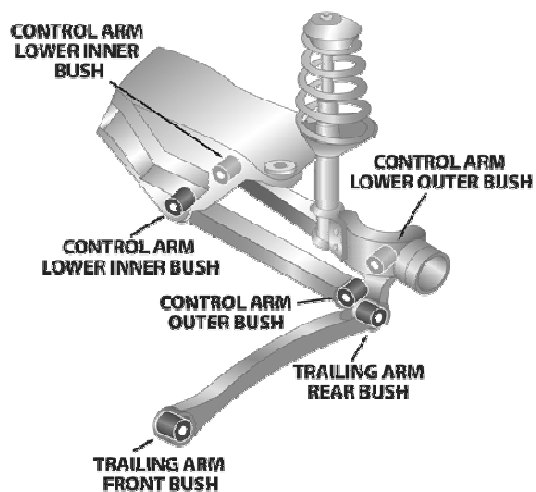
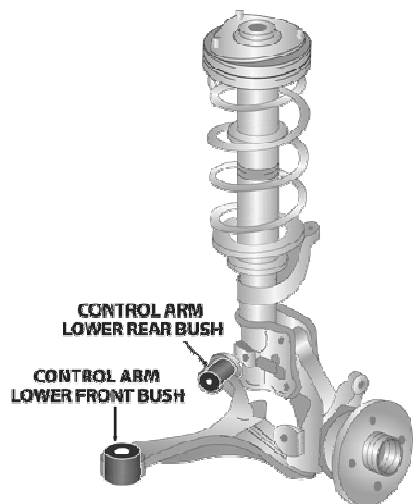

**CHRYSLER Neon Sedan - 7/1996 - 8/1999**

Página 1









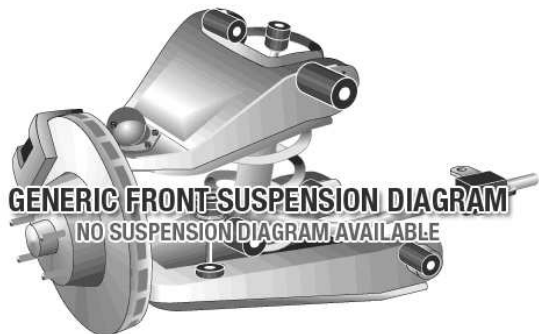

Aplicaci...	Descripción	Referencia	Kits por...	Contenido del Kit	
TRAS.	Sway Bar Mount To Chassis Bushing Measure bar diameter 13mm available	MPU-1643-_ _K#R&D	1	Bushings	



## CHRYSLER 300C First Generation (LX) - 2005 - 2010

Página 1



Aplicaci...	Descripción	Referencia	Kits por...	Contenido del Kit	
DEL.	Control Arm Lower-Inner Bushing 2WD Vehicle only, Standard replacement kit	<b>MPU-3052K</b>	1	Inst Sheet, Outer Shells, Inner Tubes, Bushings	 SPF3052K
DEL.	Control Arm Lower-Inner Eccentric Kit 2WD Vehicle only, 1 x standard & 1 x offset for camber +/- adjustment	<b>MPU-3053K</b>	1	Inst Sheet, Outer Shells, Inner Tubes, Bushings	 SPF3053K
DEL.	Control Arm Lower-Inner Eccentric Kit 2WD Vehicle only, 2 x offset bushings for +/- camber adjustment	<b>MPU-3054K</b>	1	Inst Sheet, Outer Shells, Inner Tubes, Bushings	 SPF3054K
DEL.	Control Arm Lower-Outer Bushing Shock absorber lower mount	<b>MPU-3055K</b>	1	Outer Shells, Inner Tubes, Bushings	 SPF3055K
DEL.	Control Arm Upper-Inner Kit	<b>MPU-3051K</b>	1	Inst Sheet, Outer Shells, Inner Tubes, Bushings	 SPF3051K
DEL.	Steering Rack & Pinion Mount Bushing Both sides	<b>MPU-3056K</b>	1	Inst Sheet, Inner Tubes, Bushings	 SPF3056K
DEL.	Strut Bar To Chassis Mount Kit 2WD Vehicle only, Standard replacement	<b>MPU-3048K</b>	1	Inst Sheet, Outer Shells, Inner Tubes, Bushings	 SPF3048K





## CHRYSLER 300C First Generation (LX) - 2005 - 2010

Página 2 (Continúa)

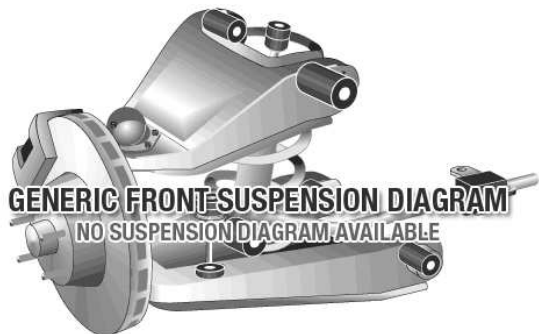







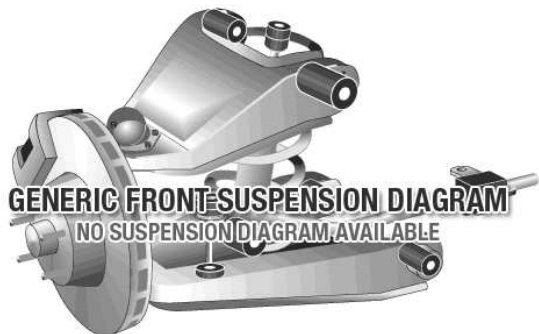

Aplicaci...	Descripción	Referencia	Kits por...	Contenido del Kit	
DEL.	Strut Bar To Chassis Mount-Adjustable Bushing 2WD Vehicle only, 1 x standard & 1 x offset bushing for castor adjustment	<b>MPU-3049K</b>	1	Inst Sheet, Outer Shells, Inner Tubes, Bushings	
DEL.	Strut Bar To Chassis Mount-Adjustable Bushing 2WD Vehicle only, 2 x offset bushings for castor adjustment	<b>MPU-3050K</b>	1	Inst Sheet, Outer Shells, Inner Tubes, Bushings	
DEL.	Sway Bar Mount Bushing Measure bar diameter, 21,30,32mm available	<b>MPU-2914-__K</b>	1	Bushings	
F & R	SuperPro Alignment & Enhancement Kit (Performance) SPF3050Kx1, SPF3051Kx1, SPF3056Kx1, SPF3054Kx1, SPF3055Kx1, SPF3064Kx1, SPF3059Kx1, SPF3058Kx1, SPF3064Kx1, SPF3060Kx1 See any notes listed against individual part numbers...	<b>MPK-167K</b>	1	Outer Shells, Inner Tubes, Bushings	
F & R	SuperPro Enhancement Kit (Standard) SPF3048Kx1, SPF3051Kx1, SPF3056Kx1, SPF3052Kx1, SPF3055Kx1, SPF3057Kx1, SPF3059Kx1, SPF3058Kx1, SPF3057Kx1, SPF3060Kx1. See any...	<b>MPK-166K</b>	1	Outer Shells, Inner Tubes, Bushings	
TRAS.	Shock Absorber Lower Bushing	<b>MPU-3063K</b>	1	Inner Tubes, Bushings	



## CHRYSLER 300C First Generation (LX) - 2005 - 2010

Página 3 (Continúa)







Aplicaci...	Descripción	Referencia	Kits por...	Contenido del Kit	
TRAS.	Control Arm Lower-Inner Bushing Bushing located in sub frame	<b>MPU-3059K</b>	1	Inst Sheet, Inner Tubes, Bushings	 SPF3059K
TRAS.	Control Arm Upper-Inner / Outer Kit Standard replacement	<b>MPU-3057K</b>	1	Inst Sheet, Outer Shells, Inner Tubes, Bushings	
TRAS.	Control Arm Upper-Inner or Outer..... Eccentric Bushing Camber +/- adjustment kit 0.75-1 degree change	<b>MPU-3064K</b>	1	Inst Sheet, Outer Shells, Inner Tubes, Bushings	 SPF3064K
TRAS.	Shock Absorber Upper Bushing	<b>MPU-3062K</b>	1	Inner Tubes, Bushings	 SPF3062K
TRAS.	Sway Bar Link Bushing Kit Upper & lower position, replaces OE# 04782892AB 43546C	<b>MPU-2916K</b>	1	Inner Tubes, Bushings	 SPF2916K
TRAS.	Sway Bar Mount Bushing Measure bar diameter 15,16 & 20mm available, Original part number 47855D 61761	<b>MPU-2915-__K</b>	1	Bushings	 SPF2915- K
TRAS.	Toe Control Arm-Inner Bush & Outer....Bushings Kit	<b>MPU-3060K</b>	1	Inst Sheet, Outer Shells, Inner Tubes, Bushings	 SPF3060K

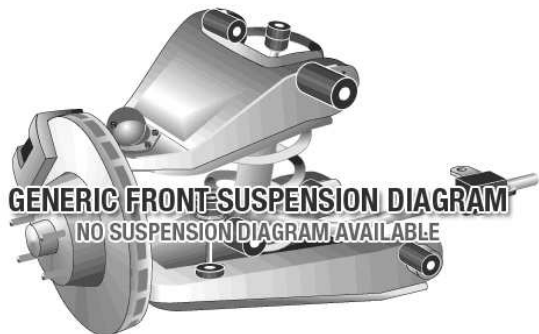

## CHRYSLER 300C First Generation (LX) - 2005 - 2010

Página 4 (Continúa)





Aplicaci...	Descripción	Referencia	Kits por...	Contenido del Kit	
TRAS.	Toe Control Arm-Inner Bush & Outer....Bushing Kit This kit is needed to maintain toe, when SPF3064K is fitted. Offset tube in kit.	<b>MPU-3060XK</b>	1	Inst Sheet, Outer Shells, Inner Tubes, Bushings	 SPF3060K
TRAS.	Trailing Arm Lower Bushing All Services both front & rear of the arms, Rear position is located in the hub	<b>MPU-3058K</b>	1	Inst Sheet, Outer Shells, Inner Tubes, Bushings	 SPF3058K
TRAS.	Trailing Arm Upper Adjustable Bushing Front & Rear of the arm; Camber +/- adjustment kit 0.75-1 degree camber change.	<b>MPU-3064K</b>	1	Inst Sheet, Outer Shells, Inner Tubes, Bushings	 SPF3064K
TRAS.	Trailing Arm Upper Bushing All Standard replacement, kit services both front & rear of the arms.	<b>MPU-3057K</b>	1	Inst Sheet, Outer Shells, Inner Tubes, Bushings	

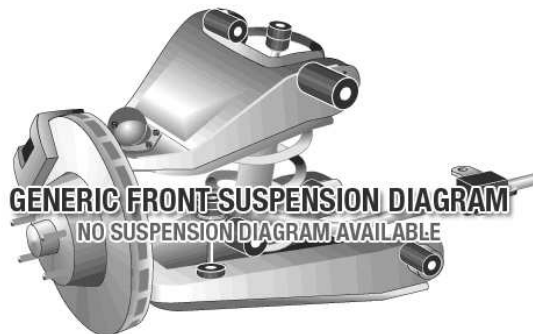
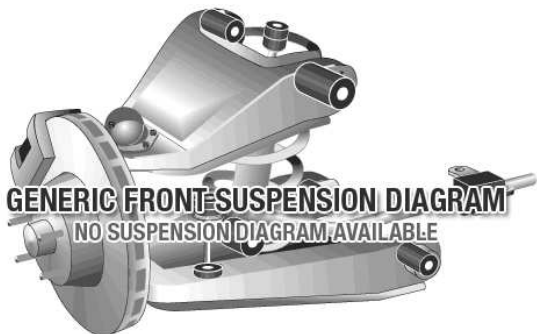

## CHRYSLER Voyager RG 4th Generation - 2001 - 2007

Página 1









Aplicaci...	Descripción	Referencia	Kits por...	Contenido del Kit	
DEL.	Control Arm Lower Rear Bushing	<b>MPU-3759K</b>	1	Bushings	

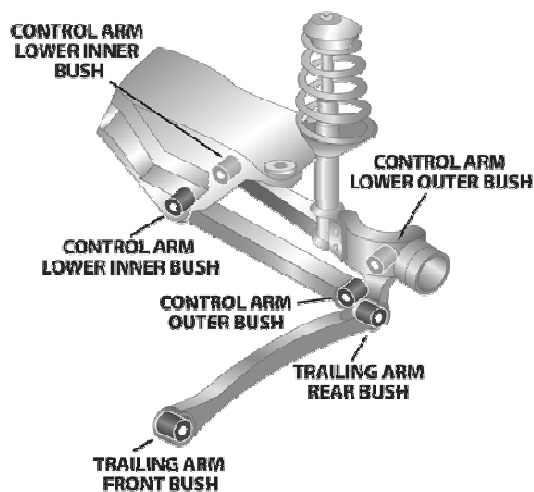
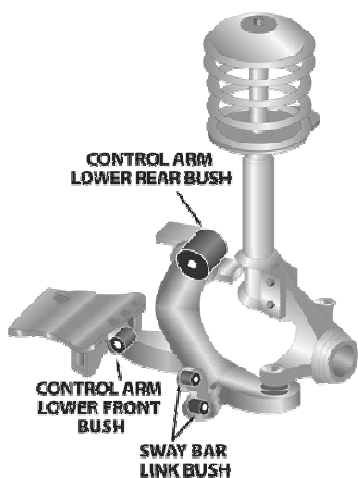

## DAEWOO 1.5i 3 Door Hatchback - 8/1994 - 10/1995

Página 1









Aplicaci...	Descripción	Referencia	Kits por...	Contenido del Kit	
DEL.	Sway Bar Link Bushing Kit	<b>MPU-2092K</b>	1	Bushings	 SPF2092K
DEL.	Control Arm Lower Rear Bushing PS & DS standard	<b>MPU-1122K</b>	1	Bushings, Washers	 1 1 2 2 - _ K
DEL.	Control Arm Lower Rear Bushing PS increased DS standard caster	<b>MPU-1123K</b>	1	Bushings, Washers	 1 1 2 3 K
DEL.	Control Arm Lower Rear Bushing PS increased DS decrease caster	<b>MPU-1124K</b>	1	Bushings, Washers	 1 1 2 4 K
TRAS.	Shock Absorber Upper Bushing	<b>MPU-1577K</b>	1	Bushings	 1 5 7 7 K

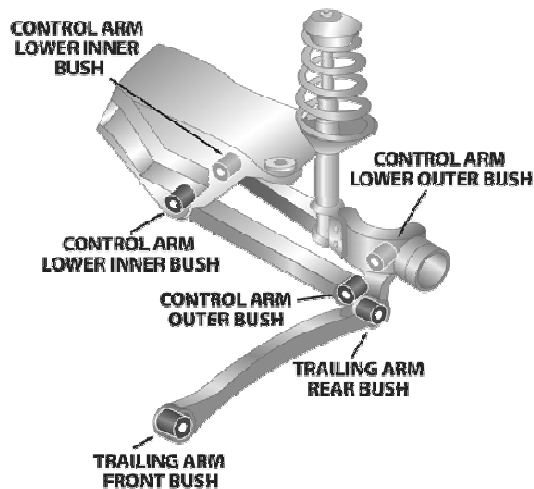
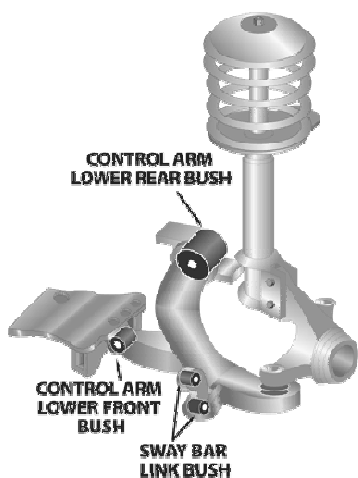

DAEWOO Cielo GLX 5 Door Hatch - 9/1994 - 2004

Página 1







Aplicaci...	Descripción	Referencia	Kits por...	Contenido del Kit	
DEL.	Control Arm Lower Rear Bushing PS & DS standard	<b>MPU-1122K</b>	1	Bushings, Washers	
DEL.	Control Arm Lower Rear Bushing PS increased DS standard caster	<b>MPU-1123K</b>	1	Bushings, Washers	
DEL.	Control Arm Lower Rear Bushing PS increased DS decrease caster	<b>MPU-1124K</b>	1	Bushings, Washers	
DEL.	Sway Bar Link Bushing Kit	<b>MPU-2092K</b>	1	Bushings	
TRAS.	Shock Absorber Upper Bushing	<b>MPU-1577K</b>	1	Bushings	

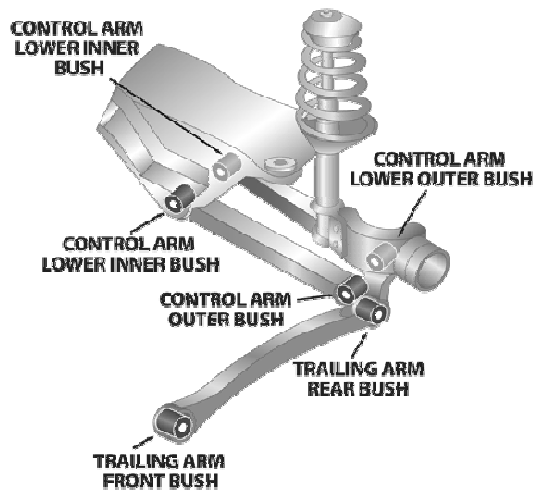
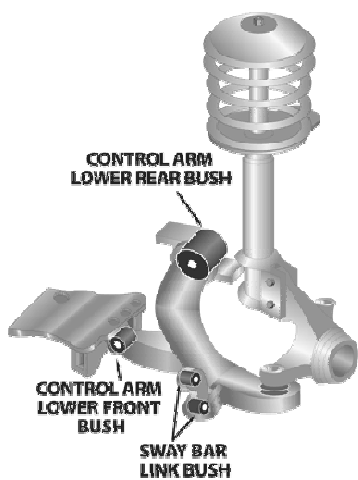

**DAEWOO Lanos Sedan - 8/1997 - 2002**

Página 1





Aplicaci...	Descripción	Referencia	Kits por...	Contenido del Kit	
DEL.	Sway Bar Link Bushing Kit	<b>MPU-2755SK</b>	2	Bushings	
DEL.	Sway Bar Mount To Chassis Bushing Measure bar diameter 25.5 available	<b>MPU-1751-__K</b>	1	Bushings	

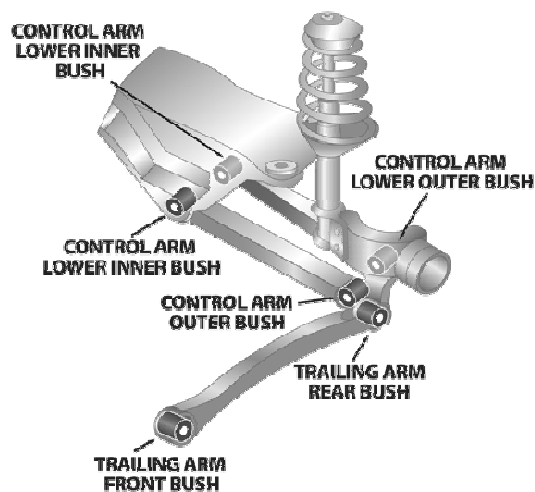
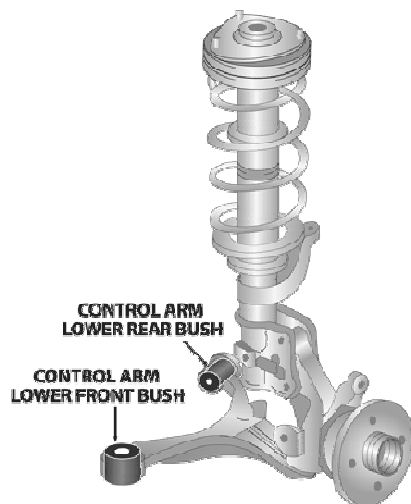

## DAEWOO Nubira J100 - 7/1997 - 11/1999

Página 1



Aplicaci...	Descripción	Referencia	Kits por...	Contenido del Kit	
DEL.	Control Arm Lower Rear Bushing Standard	<b>MPU-1949K</b>	1	Inner Tubes, Bushings	 SPF1949K
DEL.	Control Arm Lower-Front Bushing	<b>MPU-1948K</b>	1	Inner Tubes, Bushings	 SPF1948K
DEL.	Steering Rack & Pinion Mount Bush.....Power Steering	<b>MPU-2929K</b>	1	Bushings, Inner Tubes	





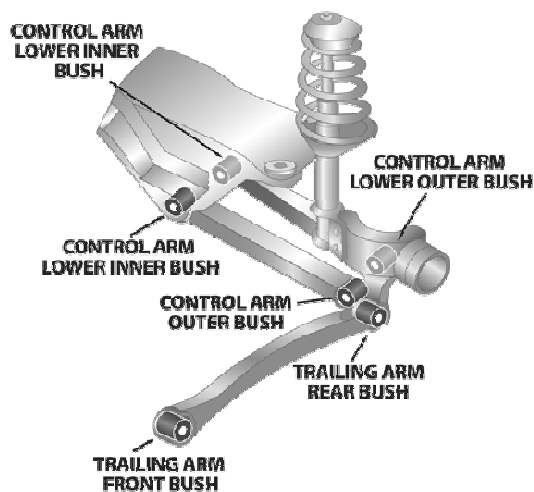
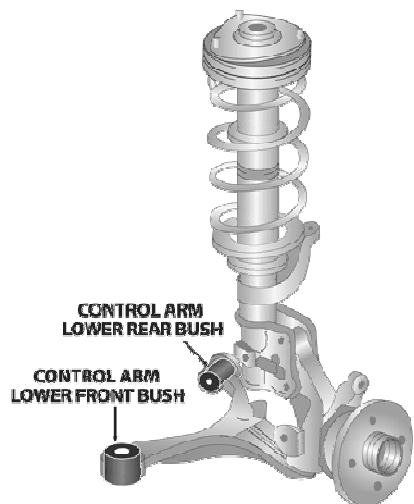

**DAEWOO Nubira J150 - 11/1999 - 8/2003**

Página 1









Aplicaci...	Descripción	Referencia	Kits por...	Contenido del Kit	
DEL.	Control Arm Lower Rear Bushing Standard	<b>MPU-1949K</b>	1	Inner Tubes, Bushings	 SPF1949K
DEL.	Control Arm Lower-Front Bushing	<b>MPU-1948K</b>	1	Inner Tubes, Bushings	 SPF1948K

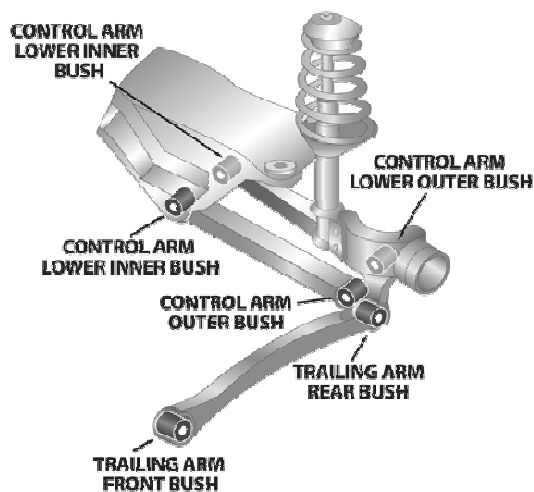
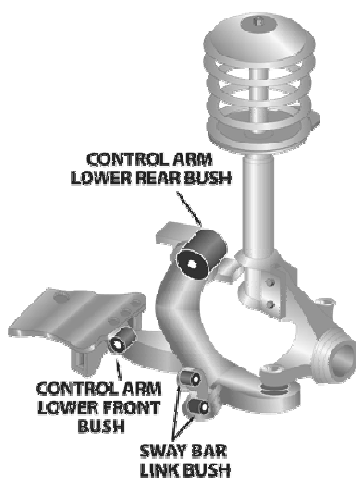

## DAEWOO Espero CD, Sedan - 3/1995 - 2004

Página 1





Aplicaci...	Descripción	Referencia	Kits por...	Contenido del Kit	
DEL.	Control Arm Lower Rear Bushing PS & DS standard	<b>MPU-1122K</b>	1	Bushings, Washers	
DEL.	Control Arm Lower Rear Bushing PS increased DS standard caster	<b>MPU-1123K</b>	1	Bushings, Washers	
DEL.	Control Arm Lower Rear Bushing PS increased DS decrease caster	<b>MPU-1124K</b>	1	Bushings, Washers	
TRAS.	Shock Absorber Upper Bushing	<b>MPU-1577K</b>	1	Bushings	

**DAEWOO Tacuma Tacuma -**

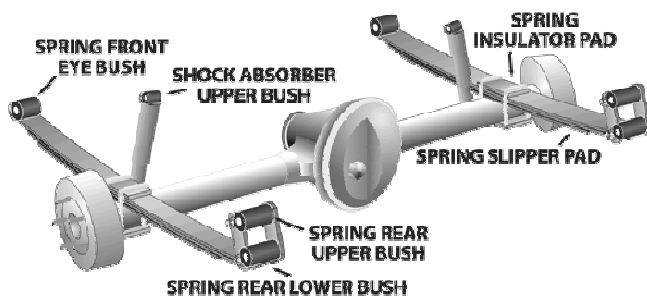
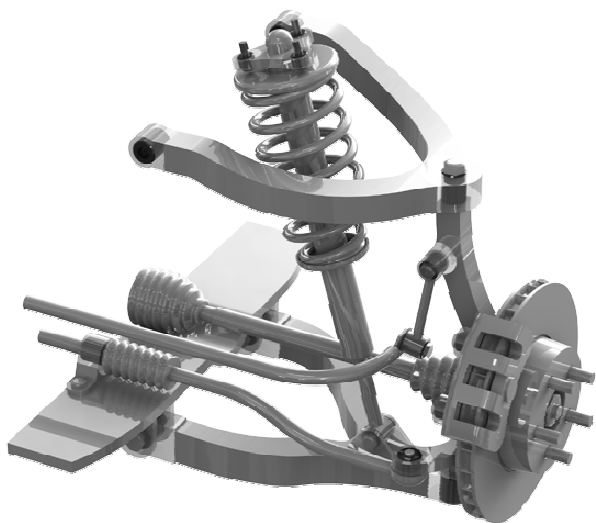
Página 1







Aplicaci...	Descripción	Referencia	Kits por...	Contenido del Kit	
DEL.	Sway Bar Mount Bushing Measure bar diameter 19.5,22mm available,OE bracket # 96444468	MPU-2655-__K	1	Bushings	

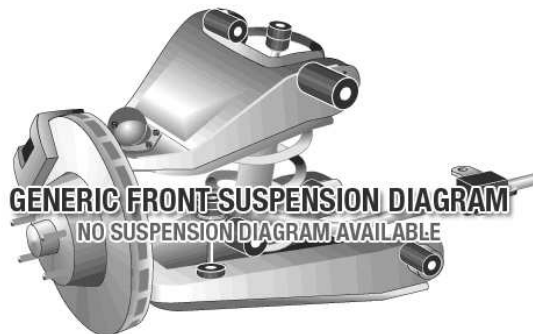
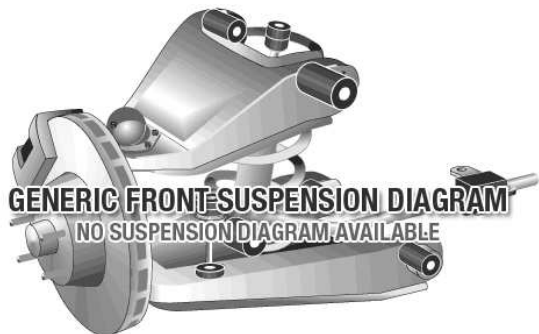

## DAEWOO Kalos 1 Generation - 2003 - 2004

Página 1





Aplicaci...	Descripción	Referencia	Kits por...	Contenido del Kit	
DEL.	Control Arm Lower Rear Bushing	<b>MPU-3846K</b>	1	Inst Sheet, Washers, Outer Shells, Inner Tubes, Bushings	
DEL.	Control Arm Lower-Inner Front Kit	<b>MPU-3848K</b>	1	Inner Tubes, Bushings	

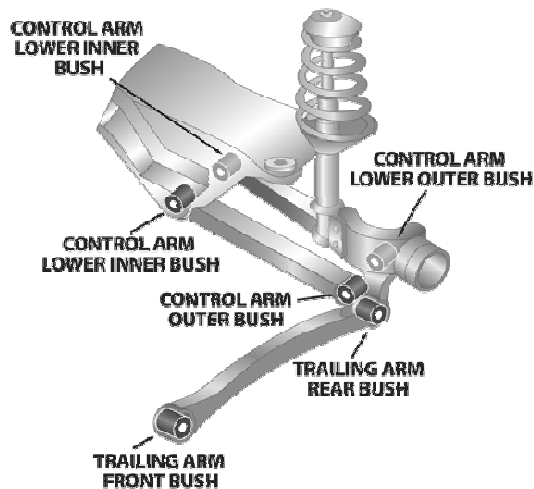
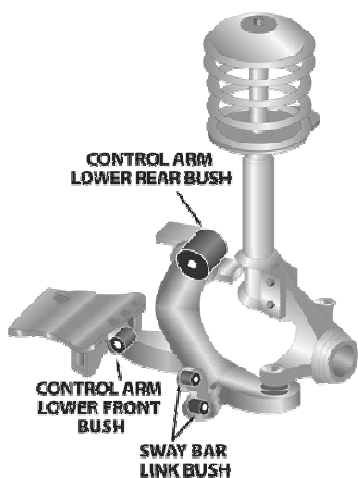

**DAIHATSU Charade G11 - G30 - 1/1983 - 5/1987**

Página 1







Aplicaci...	Descripción	Referencia	Kits por...	Contenido del Kit	
DEL.	Sway Bar Mount To Chassis Bushing Measure bar diameter 22,24,27mm available	<b>MPU-0744-__K</b>	1	Bushings	

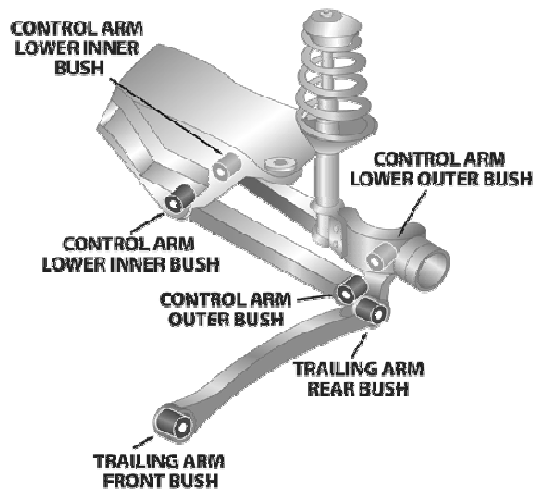
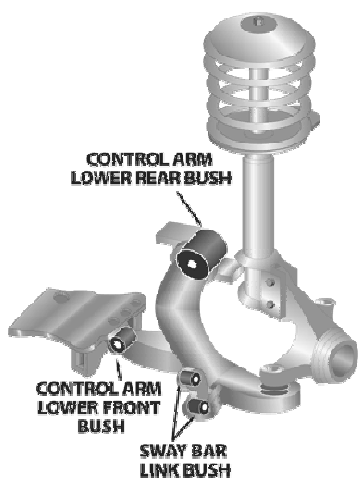

## DAIHATSU Charade Centro Hatch / Van - 4/1995 - 2/1999

Página 1



Aplicaci...	Descripción	Referencia	Kits por...	Contenido del Kit	
DEL.	Strut Mount Bushing Raises vehicle cack to OE ride height + 5mm	<b>MPU-0746K</b>	1	Bushings	
DEL.	Sway Bar To Lower Control Arm Kit	<b>MPU-0742K</b>	1	Bushings	



## DAIHATSU Charade G200 & G200 Series 2 - 6/1993 - 2000

Página 1

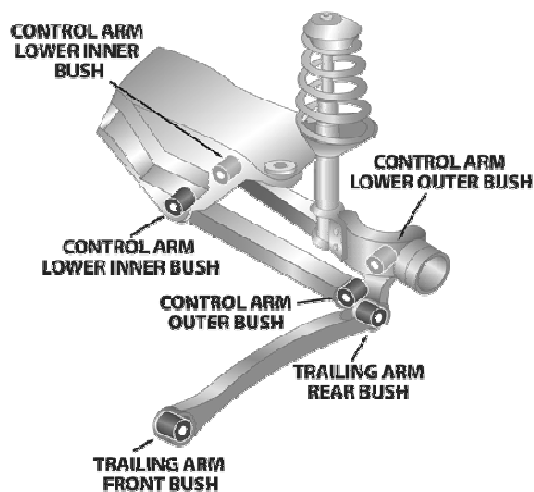
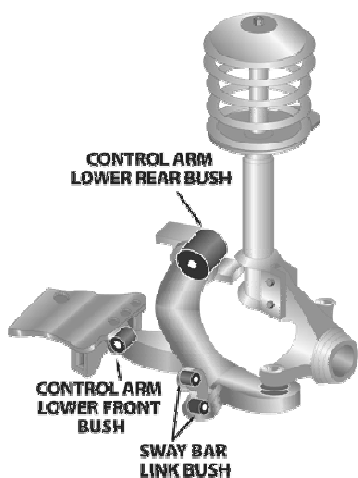

Aplicaci...	Descripción	Referencia	Kits por...	Contenido del Kit	
DEL.	Sway Bar Mount To Chassis Bushing After-market bar measure bar diameter 22,24,27mm available	MPU-0744-__K	1	Bushings	
DEL.	Sway Bar To Lower Control Arm Kit	MPU-0742K	1	Bushings	
DEL.	Control Arm Lower Rear Bushing	MPU-1347K	1	Bushings	
DEL.	Control Arm Lower-Front Bushing	MPU-1346K	1	Inner Tubes, Bushings	
TRAS.	Control Arm Outer Front & Rear Kit Bushes located in stub axle	MPU-0898K	1	Inner Tubes, Bushings	
TRAS.	Control Arm-Inner Front Bushing	MPU-0898-4K	1	Bushings, Inner Tubes	
TRAS.	Control Arm-Inner Rear Bushing Toe adjusting arm	MPU-1350K	1	Bushings, Inner Tubes	



## DAIHATSU Charade G200 & G200 Series 2 - 6/1993 - 2000

Página 2 (Continúa)

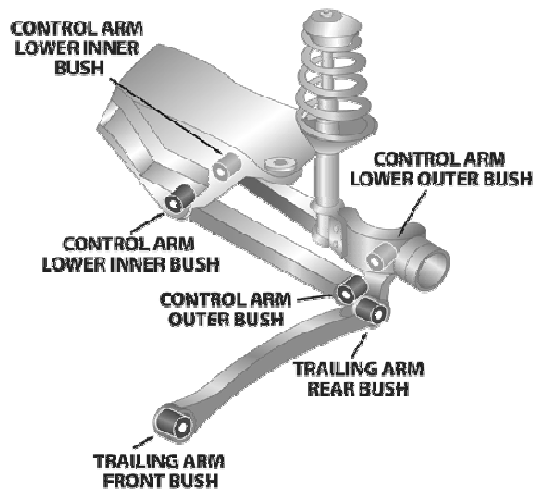
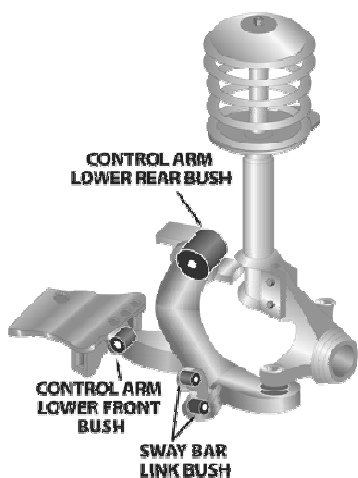

Aplicaci...	Descripción	Referencia	Kits por...	Contenido del Kit	
TRAS.	Spring Insulator Bushing Standard height vehicle	MPU-0751K	2	Bushings	
TRAS.	Sway Bar Link Upper Bushing Upper position only	MPU-0306-4K	1	Bushings	
TRAS.	Sway Bar Mount To Chassis Bushing Measure bar diameter 16,17,18,20,22,23,24mm available	MPU-0743-__K	1	Bushings	
TRAS.	Trailing Arm - Bushing Kit	MPU-0750K	1	Inner Tubes, Bushings	





## DAIHATSU Charade G100, G102 - 6/1987 - 6/1993

Página 1

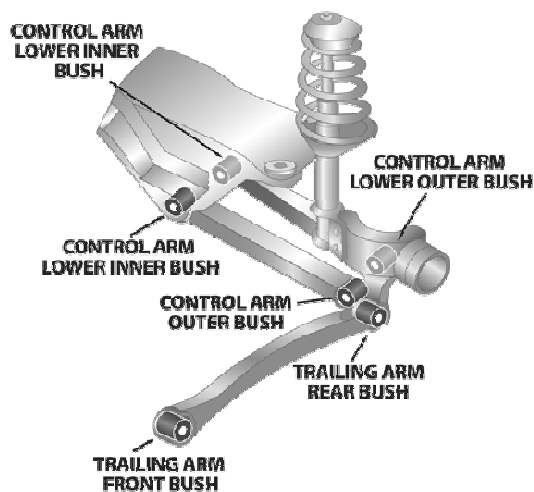
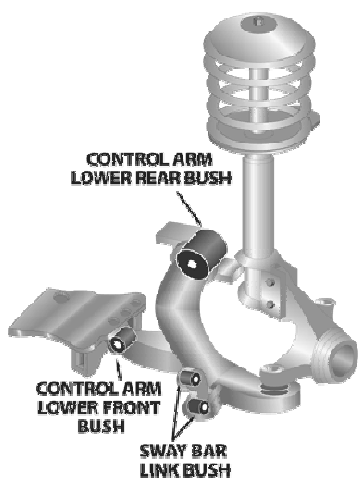

Aplicaci...	Descripción	Referencia	Kits por...	Contenido del Kit	
DEL.	Control Arm Lower-Inner Bushing G102	<b>MPU-0748K</b>	1	Inner Tubes, Bushings	
DEL.	Steering Rack & Pinion Mount Bush....Manual Steering G102	<b>MPU-0747K</b>	1	Bushings	
DEL.	Strut Mount Bushing G102. Raises vehicle back to OE ride height + 5mm	<b>MPU-0746K</b>	1	Bushings	
DEL.	Sway Bar Mount To Chassis Bushing Measure bar diameter 22,24,27mm available	<b>MPU-0744-__K</b>	1	Bushings	
DEL.	Sway Bar To Lower Control Arm Kit	<b>MPU-0742K</b>	1	Bushings	
TRAS.	Control Arm Inner-Front & Rear Kit	<b>MPU-0749K</b>	1	Inner Tubes, Bushings	
TRAS.	Control Arm Outer Front & Rear Kit Bushings located in stub axle	<b>MPU-0898K</b>	1	Inner Tubes, Bushings	



## DAIHATSU Charade G100, G102 - 6/1987 - 6/1993

Página 2 (Continúa)

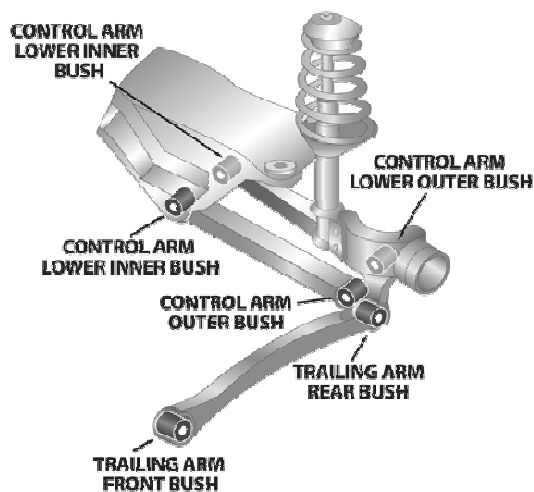
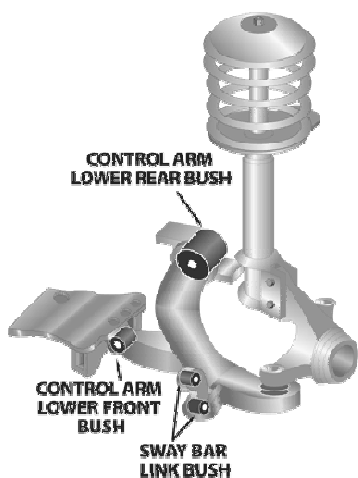







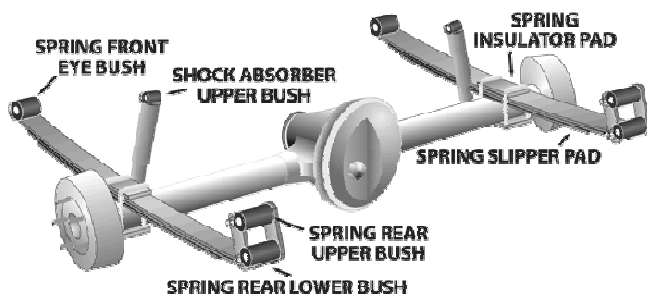
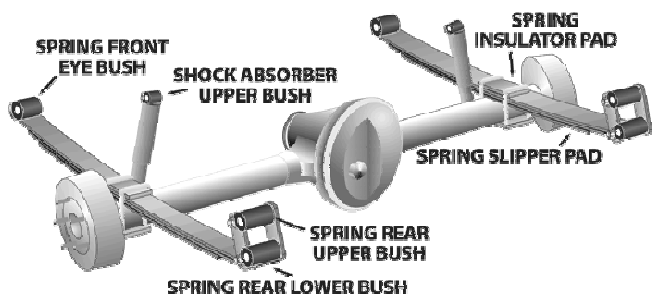

Aplicaci...	Descripción	Referencia	Kits por...	Contenido del Kit	
TRAS.	Spring Insulator Bushing Standard height vehicle	<b>MPU-0751K</b>	2	Bushings	
TRAS.	Sway Bar Link Bushing Kit	<b>MPU-0306K</b>	1	Bushings	
TRAS.	Sway Bar Mount To Chassis Bushing Measure bar diameter 16,17,18,20,22,23,24mm,Body height 37.7mm	<b>MPU-0743-__K</b>	1	Bushings	
TRAS.	Sway Bar Mount To Chassis Bushing Measure bar diameter 16,17,23,25mm available,Body height 30.5mm	<b>MPU-0899-__K</b>	1	Bushings	
TRAS.	Trailing Arm - Bushing Kit	<b>MPU-0750K</b>	1	Inner Tubes, Bushings	



DAIHATSU F Series 4WD F20, F50, F60 - 8/1975 - 6/1984

Página 1







Aplicaci...	Descripción	Referencia	Kits por...	Contenido del Kit	
DEL.	Shock Absorber Upper / Lower Bushing	MPU-2178-16K	2	Bushings	
DEL.	Spring Front Eye Bushing	MPU-0316K	1	Inner Tubes, Bushings	
DEL.	Spring Rear Eye Bushing	MPU-0315K	1	Bushings	
DEL.	Spring Shackle Upper Bushing	MPU-0317K	1	Bushings	
F & R	Leaf Spring Bushing All Complete bushing kit for front and rear leaf springs	MPK-110K	1	Inner Tubes, Bushings	
TRAS.	Shock Absorber Upper / Lower Bushing	MPU-2178-16K	2	Bushings	
TRAS.	Spring Front Eye Bushing	MPU-0315K	1	Bushings	

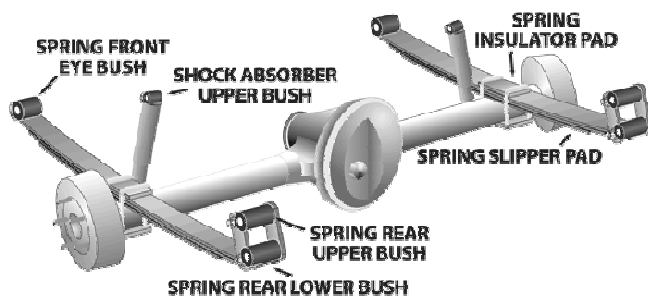
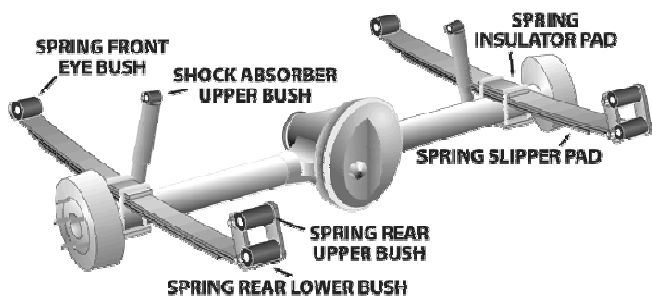

**DAIHATSU F Series 4WD F20, F50, F60 - 8/1975 - 6/1984**

Página 2 (Continúa)



Aplicaci...	Descripción	Referencia	Kits por...	Contenido del Kit	
TRAS.	Spring Rear Eye Bushing	<b>MPU-0316K</b>	1	Inner Tubes, Bushings	 0 3 1 6 K
TRAS.	Spring Shackle Upper Bushing	<b>MPU-0317K</b>	1	Bushings	 0 3 1 7 K



DAIHATSU F Series 4WD Tray back F25, F55, F65 - 11/1978 - ...

Página 1

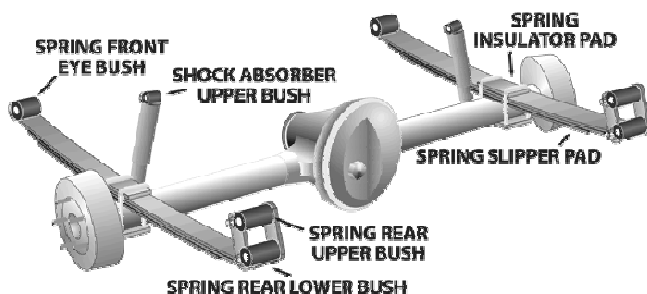
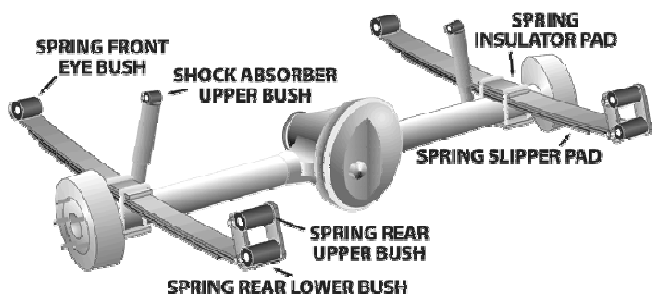





Aplicaci...	Descripción	Referencia	Kits por...	Contenido del Kit	
DEL.	Spring Front Upper Bushing 31.5mm OD hole in chassis	<b>MPU-0317K</b>	1	Bushings	
DEL.	Spring Front Eye Bushing 50mm wide spring	<b>MPU-0316K</b>	1	Inner Tubes, Bushings	
DEL.	Spring Front Upper Bushing 45mm OD hole in chassis	<b>MPU-0698K</b>	1	Bushings	
DEL.	Spring Rear Eye Bushing 60mm wide spring	<b>MPU-0238K</b>	1	Inner Tubes, Bushings	
DEL.	Spring Rear Eye Bushing 50mm wide spring	<b>MPU-0315K</b>	1	Bushings	
TRAS.	Shock Absorber Lower Bushing	<b>MPU-2755LK</b>	1	Bushings	
TRAS.	Shock Absorber Upper Bushing	<b>MPU-2178-16K</b>	1	Bushings	

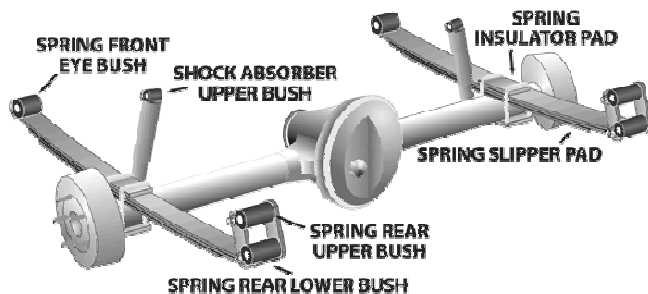
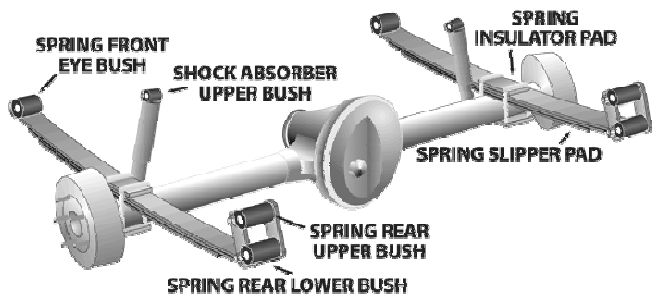

DAIHATSU F Series 4WD Tray back F25, F55, F65 - 11/1978 - ...

Página 2 (Continúa)









Aplicaci...	Descripción	Referencia	Kits por...	Contenido del Kit	
TRAS.	Spring Front Eye Bushing 60mm wide spring	MPU-0238K	1	Inner Tubes, Bushings	 0238K
TRAS.	Spring Rear Eye Bushing 50mm wide spring	MPU-0316K	1	Inner Tubes, Bushings	 0316K
TRAS.	Spring Shackle Upper Bushing	MPU-0697K	1	Bushings	

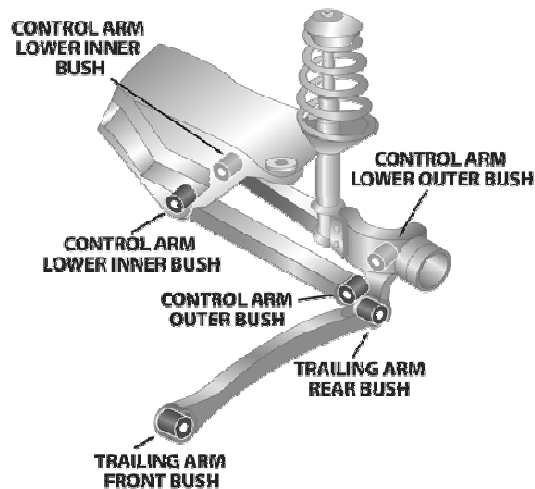
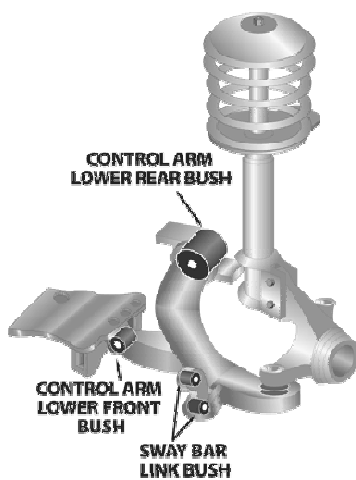

## DAIHATSU Applause A101 Sedan - 10/1989 - 8/1992

Página 1







Aplicaci...	Descripción	Referencia	Kits por...	Contenido del Kit	
DEL.	Sway Bar Mount To Chassis Bushing Measure bar diameter 22,24,27mm available	MPU-0744-__K	1	Bushings	
DEL.	Control Arm Lower-Inner Bushing	MPU-0748K	1	Inner Tubes, Bushings	
DEL.	Sway Bar Link Bushing Kit	MPU-2755SK	1	Bushings	
DEL.	Sway Bar To Lower Control Arm Kit	MPU-0742K	1	Bushings	
TRAS.	Trailing Arm - Bushing Kit	MPU-0750K	1	Inner Tubes, Bushings	

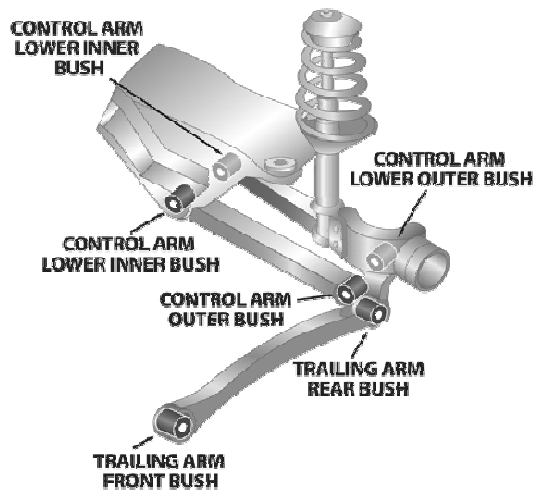
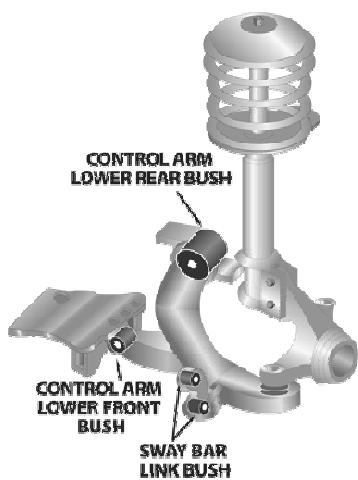

**DAIHATSU Applause A101 Sedan - 10/1997 - 5/1999**

Página 1



Aplicaci...	Descripción	Referencia	Kits por...	Contenido del Kit	
TRAS.	Control Arm Outer Front & Rear Kit	<b>MPU-0898K</b>	1	Inner Tubes, Bushings	
TRAS.	Trailing Arm - Bushing Kit	<b>MPU-0750K</b>	1	Inner Tubes, Bushings	







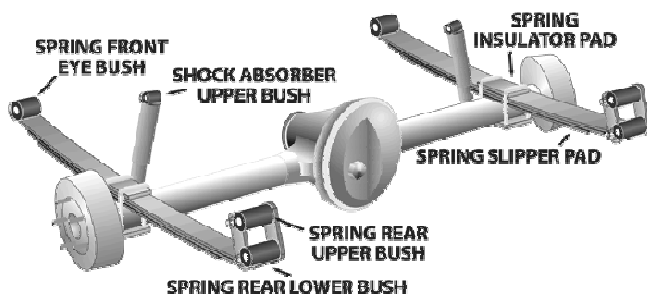
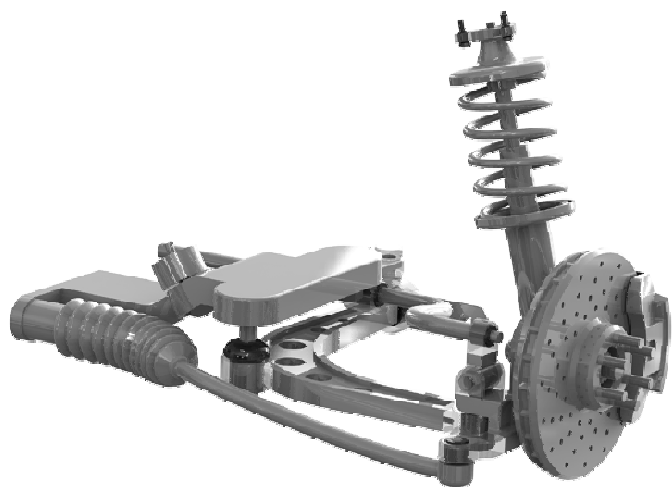

**DAIHATSU Hi-Jet Van S38, S40, S60 - 9/1971 - 8/1981**

Página 1





Aplicaci...	Descripción	Referencia	Kits por...	Contenido del Kit	
TRAS.	Shock Absorber Upper / Lower Bushing	<b>MPU-2178-16K</b>	2	Bushings	 SPF2178- K
TRAS.	Spring Front Eye Bushing	<b>MPU-0315K</b>	1	Bushings	 0 3 1 5 K
TRAS.	Spring Rear Eye Bushing	<b>MPU-0315K</b>	1	Bushings	 0 3 1 5 K
TRAS.	Spring Shackle Upper Bushing	<b>MPU-0317K</b>	1	Bushings	 0 3 1 7 K

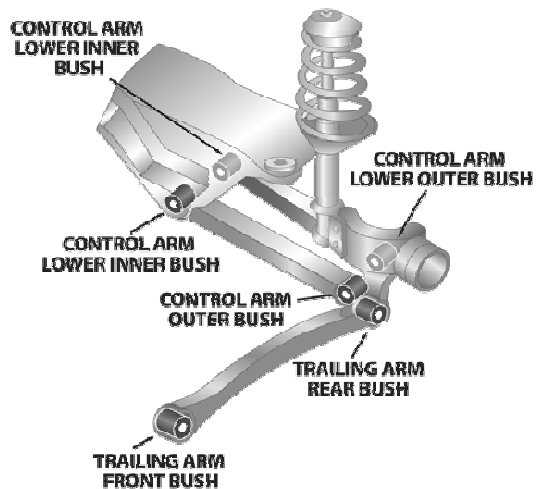
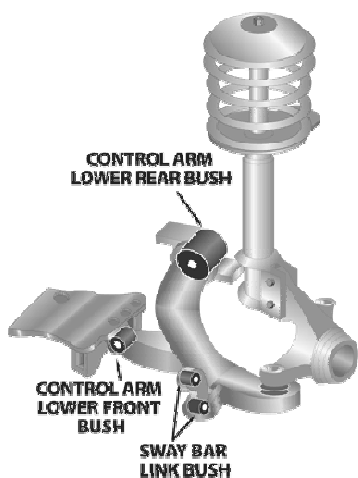

**DAIHATSU Mira L12RV, Hatch - 11/1990 - 4/1992**

Página 1









Aplicaci...	Descripción	Referencia	Kits por...	Contenido del Kit	
DEL.	Sway Bar To Lower Control Arm Kit Bar outside diameter 16mm	<b>MPU-0742K</b>	1	Bushings	

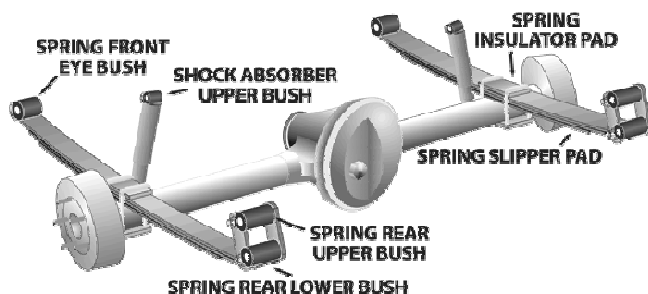
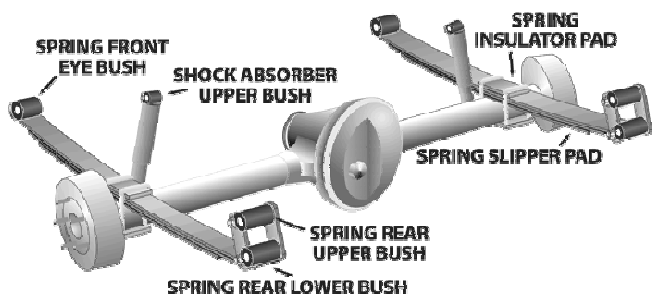

## DAIHATSU Rocky / Rugger / Fourtrak Front & Rear Coil spring...

Página 1









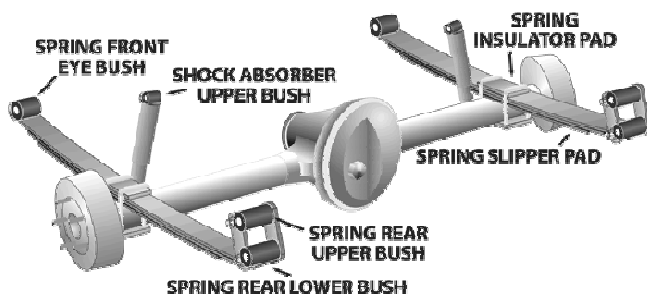
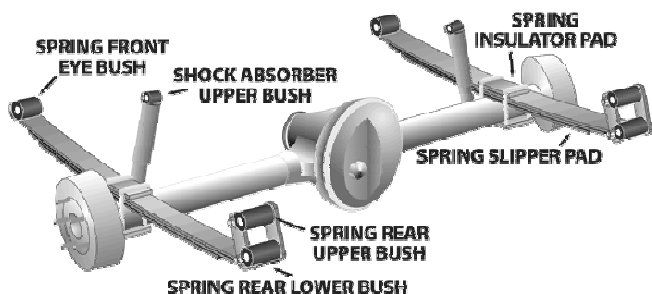

Aplicaci...	Descripción	Referencia	Kits por...	Contenido del Kit	
DEL.	Idle Arm Bushing F78	<b>MPU-1084K</b>	1	Bushings	
TRAS.	Sway Bar Mount To Chassis Bushing Measure bar 16,17,23,25mm available, F78 OE# 48818-87601	<b>MPU-0899-__K</b>	1	Bushings	
TRAS.	Trailing Arm Lower Bushing All F78 Coil spring vehicle	<b>MPU-2695K</b>	1	Inner Tubes, Bushings	
TRAS.	Trailing Arm Upper Bushing All F78 Coil spring vehicle	<b>MPU-2696K</b>	1	Inner Tubes, Bushings	



## DAIHATSU Rocky / Rugger / Fourtrak Front & Rear Leaf spring...

Página 1









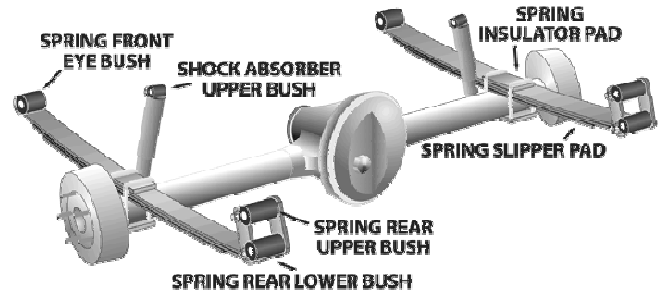
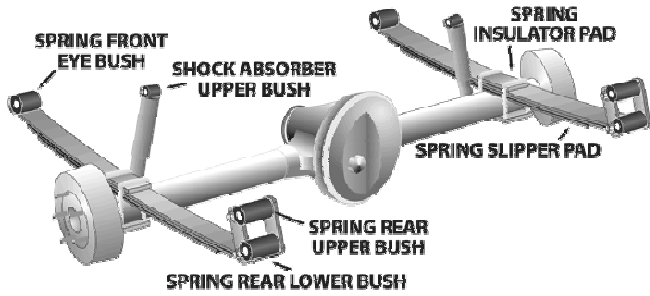

Aplicaci...	Descripción	Referencia	Kits por...	Contenido del Kit	
DEL.	Sway Bar Link To Chassis Bushing	<b>MPU-0280K</b>	1	Inner Tubes, Bushings	 SPF0280K
DEL.	Panhard Rod Bushing	<b>MPU-0872K</b>	1	Inner Tubes, Bushings	 0872K
DEL.	Shock Absorber Lower Bushing	<b>MPU-2178-16K</b>	1	Bushings	 SPF2178- K
DEL.	Shock Absorber Upper Bushing	<b>MPU-2755LK</b>	1	Bushings	 SPF2755LK
DEL.	Spring Front Eye Bushing	<b>MPU-0238K</b>	1	Inner Tubes, Bushings	 0238K
DEL.	Spring Rear Eye Bushing	<b>MPU-0238K</b>	1	Inner Tubes, Bushings	 0238K
DEL.	Spring Shackle Upper Bushing	<b>MPU-0560K</b>	1	Bushings	 560K



## DAIHATSU Rocky / Rugged / Fourtrak Front & Rear Leaf spring...

Página 2 (Continúa)









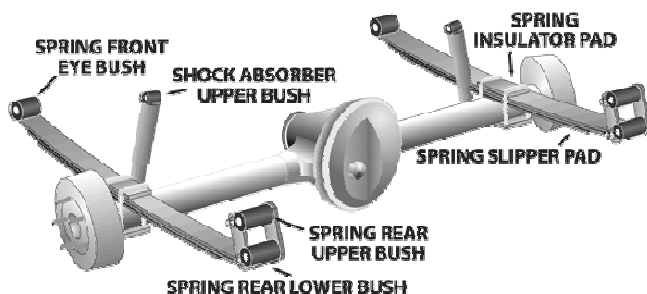
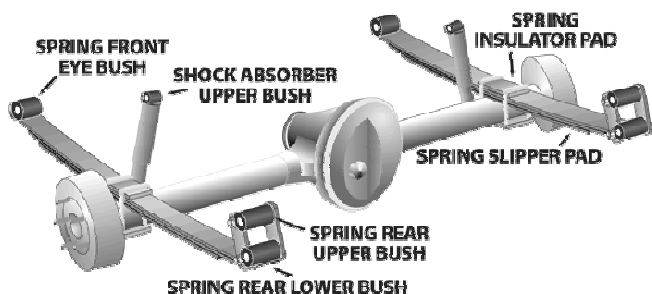

Aplicaci...	Descripción	Referencia	Kits por...	Contenido del Kit	
DEL.	Sway Bar Link To Lower Arm Bushing	<b>MPU-2092BK</b>	1	Bushings	 SPF2092BK
DEL.	Sway Bar Mount to Link Bushing Measure bar diameter 13,14,17,18,19,20,21,22,23mm available	<b>MPU-0873-__K</b>	1	Bushings	
F & R	Leaf Spring Bushing All F70 / 75 / 80RV only, Complete bushing kit for the front and rear leaf springs	<b>MPK-062K</b>	1	Inner Tubes, Bushings	
F & R	Leaf Spring Bushing All F77 / F87 only, Complete bushing kit for the front and rear leaf springs	<b>MPK-111K</b>	1	Inner Tubes, Bushings	
TRAS.	Shock Absorber Lower Bushing F77, F87	<b>MPU-2755SK</b>	1	Bushings	 SPF2755SK
TRAS.	Shock Absorber Upper Bushing F77, F87	<b>MPU-2178-16K</b>	1	Bushings	 SPF2178- K
TRAS.	Shock Absorber Upper Bushing F70, F75, F80, F85	<b>MPU-2755SK</b>	1	Bushings	 SPF2755SK



## DAIHATSU Rocky / Rugger / Fourtrak Front & Rear Leaf spring...

Página 3 (Continúa)



Aplicaci...	Descripción	Referencia	Kits por...	Contenido del Kit	
TRAS.	Spring Front Eye Bushing F77, F87	MPU-0238K	1	Inner Tubes, Bushings	 0238K
TRAS.	Spring Front Eye Bushing F70, F75, F80, F85	MPU-0239K	1	Inner Tubes, Bushings	 0239K
TRAS.	Spring Rear Eye Bushing F70, F75, F80, F85	MPU-0238K	1	Inner Tubes, Bushings	 0238K
TRAS.	Spring Rear Eye Bushing F77, F87	MPU-0316K	1	Inner Tubes, Bushings	 0316K
TRAS.	Spring Shackle Upper Bushing F70, F75, F80, F85	MPU-0560K	1	Bushings	 560K
TRAS.	Spring Shackle Upper Bushing F77, F87	MPU-0697K	1	Bushings	



**DAIHATSU Feroza I, II, III / Sporttrack 4WD - 10/1988 - 5/1998**

Página 1

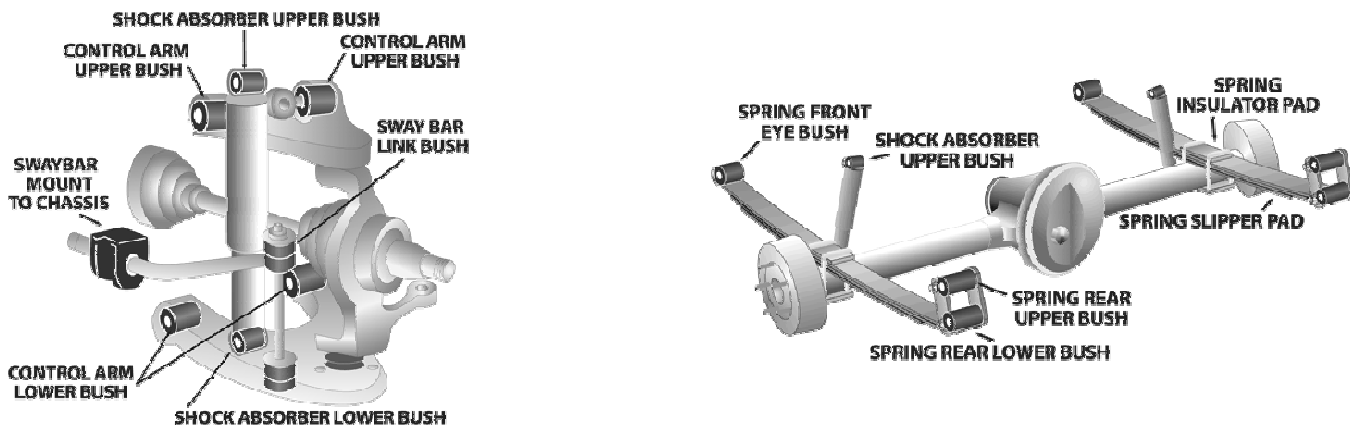







Aplicaci...	Descripción	Referencia	Kits por...	Contenido del Kit	
DEL.	Idler Arm Bushing	<b>MPU-1084K</b>	1	Bushings	
DEL.	Shock Absorber Upper Bushing	<b>MPU-2755SK</b>	1	Bushings	
DEL.	Sway Bar Link To Chassis Bushing Measure bar diameter 12mm to 30mm available	<b>MPU-1450-__K</b>	1	Bushings	
DEL.	Sway Bar To Lower Control Arm Kit	<b>MPU-2092B-4K</b>	1	Bushings	
TRAS.	Leaf Spring Bushing All SPF0238K x 1,SPF0239K x 1,SPF0560K x 1	<b>MPK-063K</b>	1		
TRAS.	Leaf Spring Bushing All Wide track SPF1227Kx1 SPF2090Kx1 SPF560Kx1	<b>MPK-064K</b>	1		
TRAS.	Shock Absorber Lower Bushing	<b>MPU-2178-16K</b>	1	Bushings	

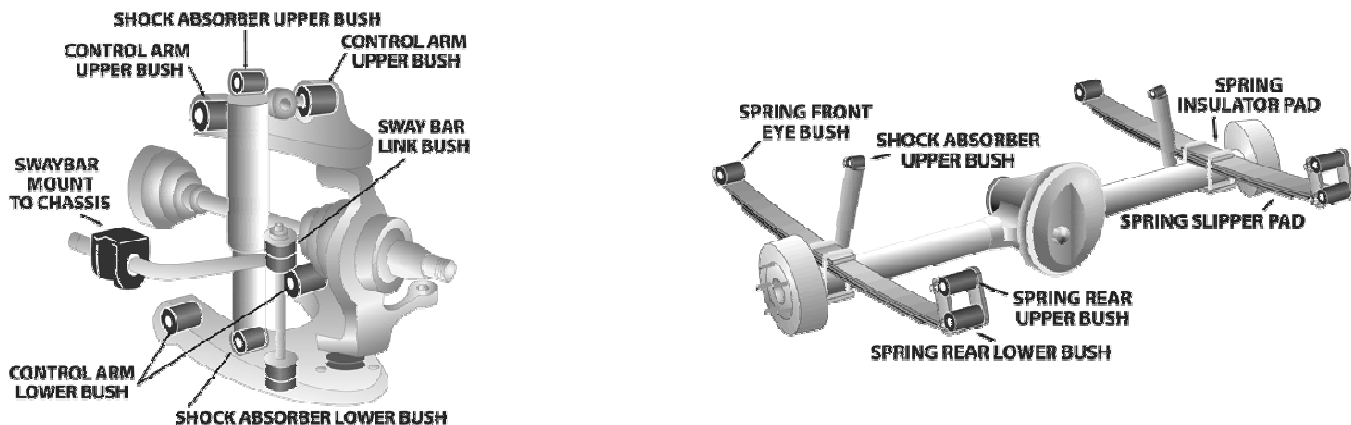

**DAIHATSU Feroza I, II, III / Sporttrack 4WD - 10/1988 - 5/1998**

Página 2 (Continúa)



Aplicaci...	Descripción	Referencia	Kits por...	Contenido del Kit	
TRAS.	Spring Front Eye Bushing	<b>MPU-0239K</b>	1	Inner Tubes, Bushings	 <b>0239K</b>
TRAS.	Spring Front Eye Bushing Wide track	<b>MPU-2090K</b>	1	Inner Tubes, Bushings	 <b>2090K</b>
TRAS.	Spring Rear Eye Bushing	<b>MPU-0238K</b>	1	Inner Tubes, Bushings	 <b>0238K</b>
TRAS.	Spring Rear Eye Bushing Wide track series with 71mm spring width	<b>MPU-1227K</b>	1	Inner Tubes, Bushings	 <b>1227K</b>
TRAS.	Spring Shackle Upper Bushing	<b>MPU-0560K</b>	1	Bushings	 <b>560K</b>







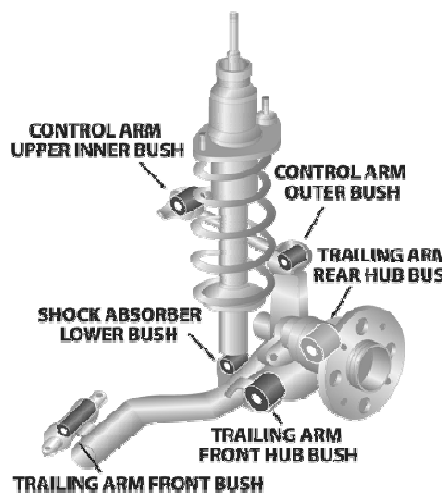
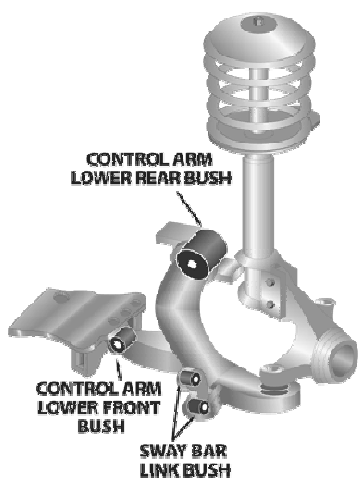

## HONDA Accord Sedan & Hatchback - 11/1989 - 10/1993

Página 1







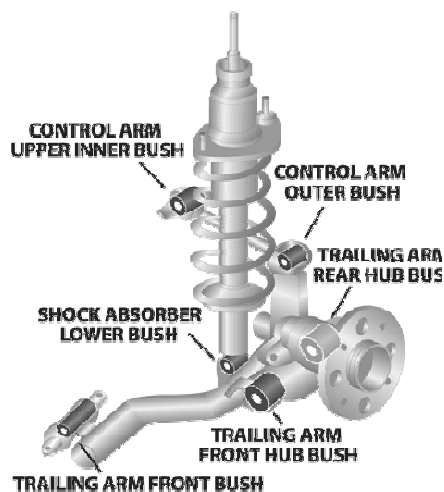
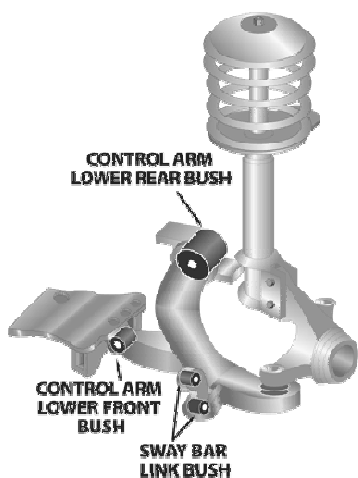

Aplicaci...	Descripción	Referencia	Kits por...	Contenido del Kit	
DEL.	Strut Bar To Chassis Mount Kit	<b>MPU-1291K</b>	1	Bushings, Inner Tubes	
DEL.	Sway Bar Mount To Chassis Bushing Measure bar diameter, 24, 25mm available	<b>MPU-0265-__K</b>	1	Bushings	
TRAS.	Sway Bar Link Bushing Kit	<b>MPU-1531K</b>	2	Inner Tubes, Bushings	
TRAS.	Sway Bar Mount To Chassis Bushing Measure bar diameter 16,17,18,20,22,24mm available	<b>MPU-0266-__K</b>	1	Bushings	

## HONDA Accord 7th Generation - 9/2003 - 2008

Página 1







Aplicaci...	Descripción	Referencia	Kits por...	Contenido del Kit	
DEL.	Control Arm Lower-Inner Front Kit Standard replacement, Replaces original part number 51391-SDB-A01	<b>MPU-2945K</b>	1	Outer Shells, Inner Tubes, Bushings	
DEL.	Control Arm Lower-Inner Front.....Eccentric Double offset bush kit, Replaces original part number 51391-SDB-A01	<b>MPU-2947K</b>	1	Outer Shells, Inner Tubes, Bushings	
DEL.	Control Arm Lower-Inner Front.....Eccentric 1 x standard & 1 x offset, wheel alignment correction, Replaces original part number...	<b>MPU-2946K</b>	1	Outer Shells, Inner Tubes, Bushings	
DEL.	Control Arm Lower-Inner Rear Kit Replaces original part number 51393-SDA-A02	<b>MPU-3075K</b>	1	Inner Tubes, Bushings	
DEL.	Control Arm Lower-Shock Mount Kit Replaces original part number 51810-SDA-A01	<b>MPU-3076K</b>	1	Outer Shells, Inner Tubes, Bushings	
DEL.	Control Arm Upper-Inner Kit	<b>MPU-3072K</b>	1	Outer Shells, Inner Tubes, Bushings	

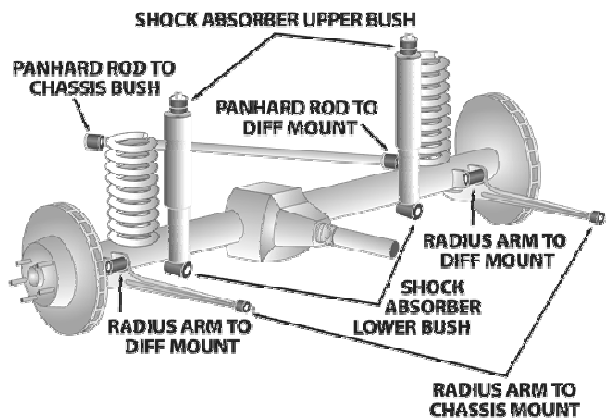
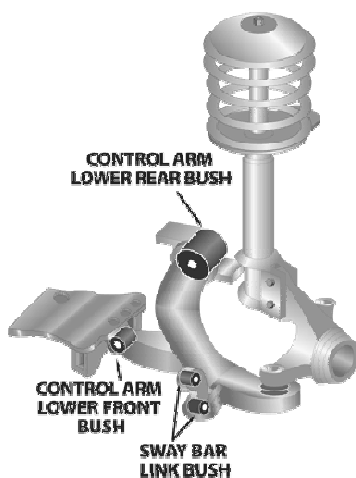

## HONDA S2000 2 Door Sports - 6/1999 - 2002

Página 1



Aplicaci...	Descripción	Referencia	Kits por...	Contenido del Kit	
DEL.	Sway Bar Mount To Chassis Bushing Measure bar diameter 27mm available	MPU-1849-__K	1	Bushings	
TRAS.	Sway Bar Mount To Chassis Bushing Measure bar diameter 27mm available	MPU-1849-__K	1	Bushings	



## HONDA CR-V Mk1 (4WD Wagon) - 1996 - 2001

Página 1

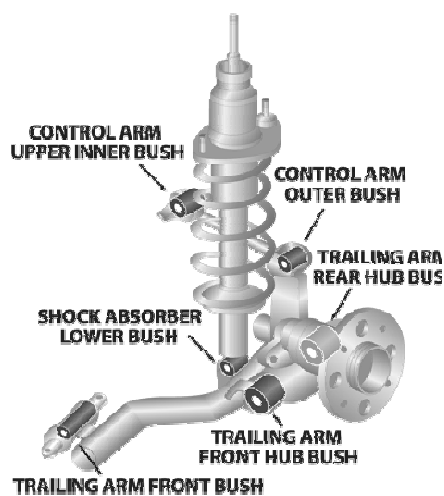
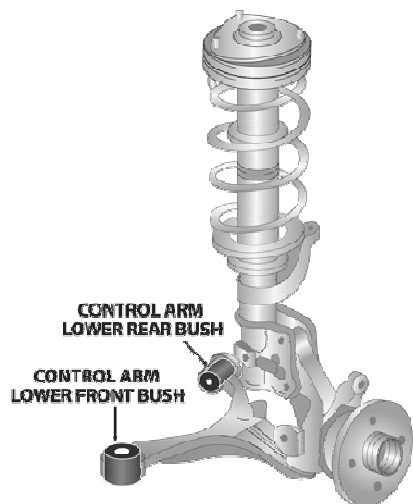







Aplicaci...	Descripción	Referencia	Kits por...	Contenido del Kit	
DEL.	Control Arm Lower-Inner Front Kit Bush OD 37mm, tube 14mm ID, 50mm long	<b>MPU-1728K</b>	1	Bushings, Inner Tubes	
DEL.	Control Arm Lower-Inner Rear Kit Standard caster setting (Hexagon style bush)	<b>MPU-1755K</b>	1	Bushings, Inner Tubes, Washers	
DEL.	Control Arm Lower-Inner Rear Kit PS increased DS standard caster(Hexagon style bush)	<b>MPU-1756K</b>	1	Bushings, Inner Tubes, Washers	
DEL.	Control Arm Lower-Inner Rear Kit PS & DS increase caster (Hexagon style bush)	<b>MPU-1757AK</b>	1	Washers, Inner Tubes, Bushings	
DEL.	Control Arm Lower-Inner Rear Kit PS increased DS decrease caster(Hexagon style bush)	<b>MPU-1757K</b>	1	Bushings, Inner Tubes, Washers	
DEL.	Sway Bar Mount To Chassis Bushing Measure bar diameter 26, 27mm available	<b>MPU-2190-__K</b>	1	Bushings	
TRAS.	Lateral Arm Rear Inner Bushing	<b>MPU-1899K</b>	1	Bushings	

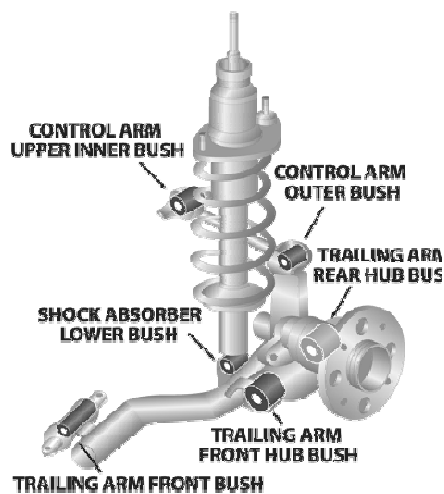
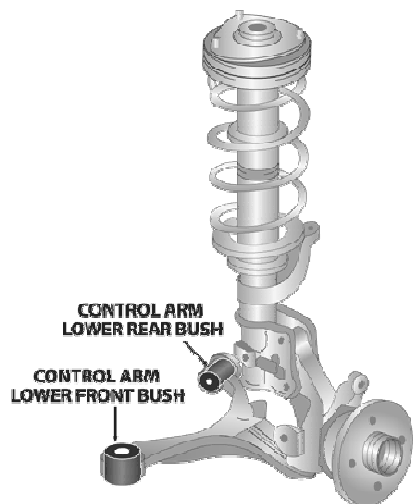

## HONDA CR-V Mk1 (4WD Wagon) - 1996 - 2001

Página 2 (Continúa)









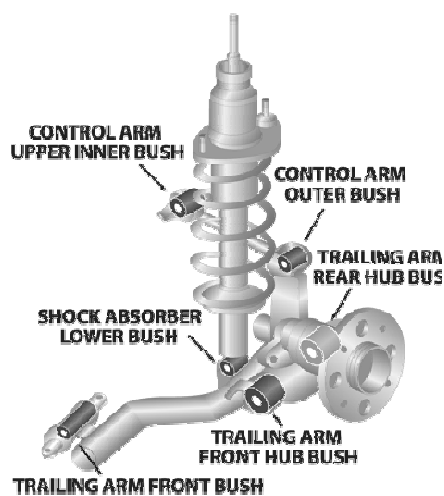
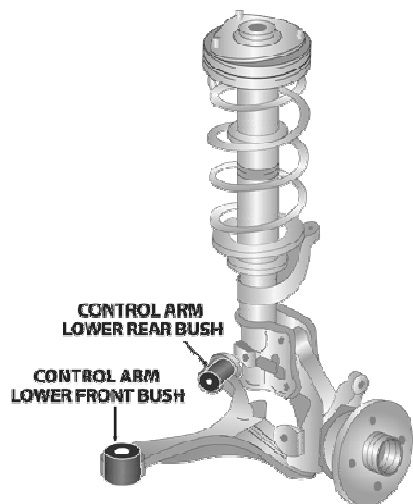

Aplicaci...	Descripción	Referencia	Kits por...	Contenido del Kit	
TRAS.	Control Arm Lower-Inner & Outer Kit Cast arm only, Not press metal arm.	<b>MPU-1530K</b>	1	Inner Tubes, Bushings	 1530K
TRAS.	Lateral Arm Rear Outer Bushing	<b>MPU-1861K</b>	1	Inner Tubes, Bushings	 1861K
TRAS.	Trailing Arm Lower Front Bushing Re-use original mount pin 30mm OD, 74mm OD bush	<b>MPU-0807K</b>	1	Bushings	 SPF0807K
TRAS.	Trailing Arm Lower Front Bushing Turbo Style Bushing Complete assembly. Replaces SPF0807K	<b>MPU-3495K</b>	1	Outer Shells, Inner Tubes, Bushings	



## HONDA CR-V Mk2 (4WD Wagon) - 2002 - 2006

Página 1





Aplicaci...	Descripción	Referencia	Kits por...	Contenido del Kit	
DEL.	Control Arm Inner-Front & Rear Kit Caster increase kit, 2 x page fitting instruction included in kit.	<b>MPU-2308K</b>	1	Outer Shells, Inner Tubes, Bushings	
DEL.	Control Arm Inner-Front & Rear Kit Standard replacement	<b>MPU-2306K</b>	1	Inst Sheet, Outer Shells, Inner Tubes, Bushings	 SPF2306K
DEL.	Sway Bar Mount To Chassis Bushing Measure bar diameter 18,20,22,23,24,27.5 28mm available	<b>MPU-2183-__K</b>	1	Bushings	
TRAS.	Control Arm Lower-Inner Rear Kit	<b>MPU-2318K</b>	1	Outer Shells, Inner Tubes, Bushings	
TRAS.	Control Arm Lower-Outer Bushing 2 x 14mm bolts, replaces OE#52365-S6M-004 & 2 x 12mm bolts, replaces OE#52365-S9A-004 or...	<b>MPU-3195K</b>	1	Inner Tubes, Bushings	
TRAS.	Control Arm Upper-Outer Bushing Standard	<b>MPU-2310K</b>	1	Bushings, Inner Tubes	
TRAS.	Control Arm Upper-Outer Bushing Adjustable camber {Increase or Decrease}	<b>MPU-2311K</b>	1	Bushings, Inner Tubes	

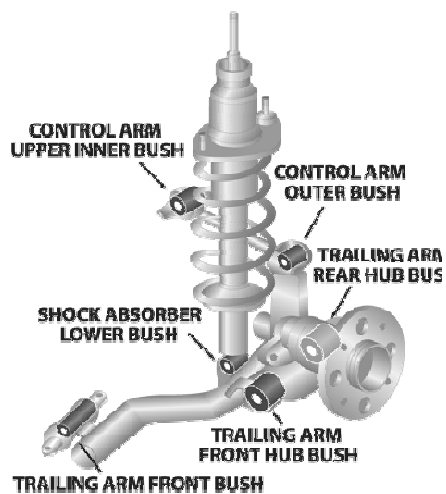
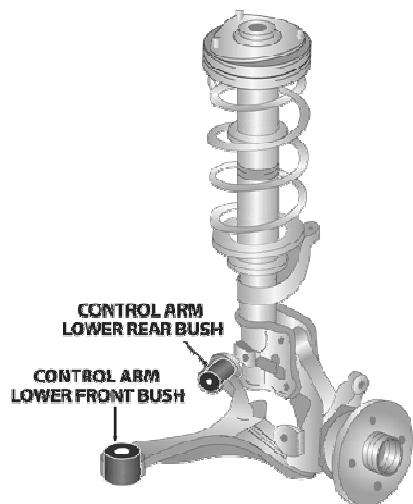

## HONDA CR-V Mk2 (4WD Wagon) - 2002 - 2006

Página 2 (Continúa)





Aplicaci...	Descripción	Referencia	Kits por...	Contenido del Kit	
TRAS.	Sway Bar Mount To Chassis Bushing Measure bar diameter, 14,18,19,20 & 22mm available	<b>MPU-2403-__K</b>	1	Bushings	

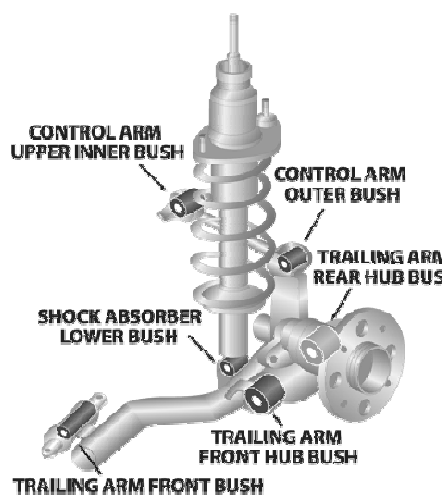
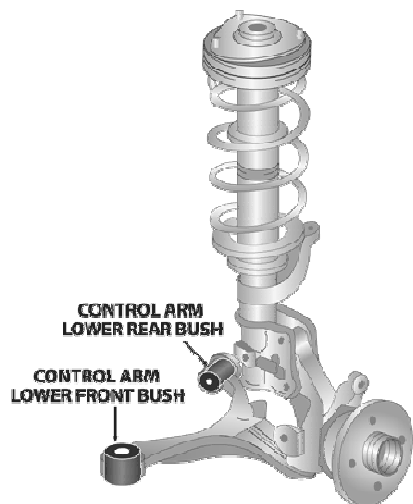

## HONDA CR-V Mk3 (4WD Wagon) - 2007 - 2011

Página 1



Aplicaci...	Descripción	Referencia	Kits por...	Contenido del Kit	
DEL.	Control Arm Lower-Front Bushing	<b>MPU-3679K</b>	1	Inner Tubes, Bushings	





## HONDA Accord Euro CL7 Sedan - 6/2003 - 2007

Página 1

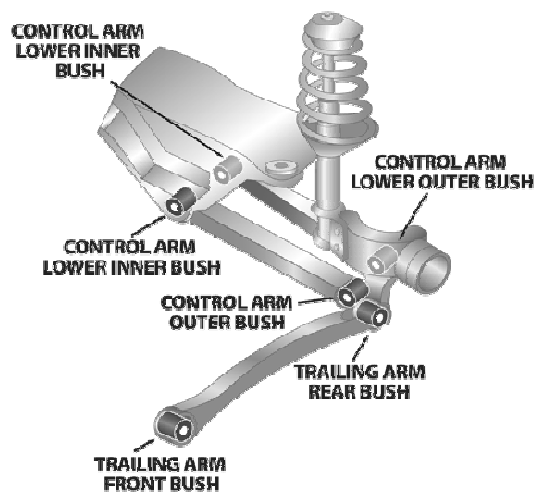
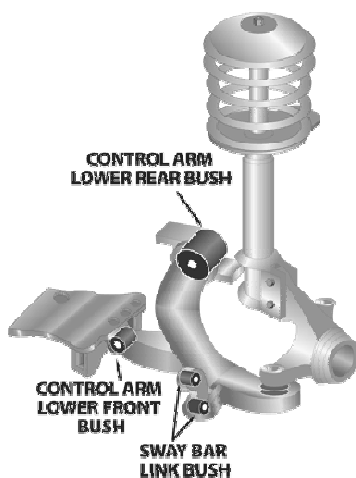







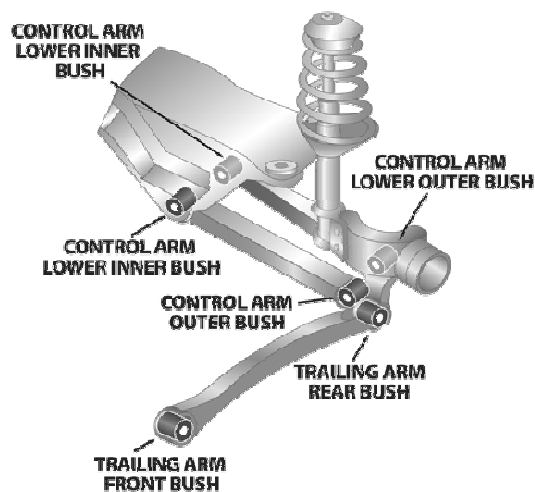
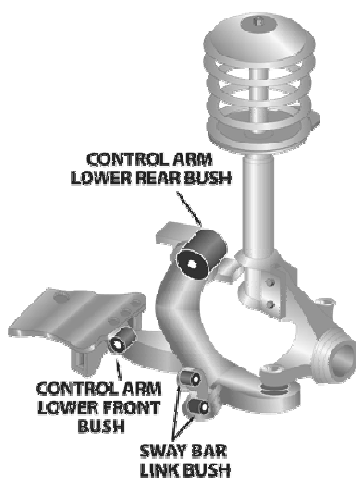

Aplicaci...	Descripción	Referencia	Kits por...	Contenido del Kit	
DEL.	Control Arm Lower-Inner Front.....Eccentric 1 x standard & 1 x offset, wheel alignment correction, Replaces original part number...	<b>MPU-2946K</b>	1	Outer Shells, Inner Tubes, Bushings	
DEL.	Control Arm Lower-Inner Front Kit Standard replacement, Replaces original part number 51391-SDB-A01	<b>MPU-2945K</b>	1	Outer Shells, Inner Tubes, Bushings	
DEL.	Control Arm Lower-Inner Front.....Eccentric Double offset bush kit, Replaces original part number 51391-SDB-A01	<b>MPU-2947K</b>	1	Outer Shells, Inner Tubes, Bushings	
DEL.	Control Arm Lower-Inner Rear Kit Replaces original part number 51393-SDA-A02	<b>MPU-3075K</b>	1	Inner Tubes, Bushings	
DEL.	Control Arm Lower-Shock Mount Kit Replaces original part number 51810-SDA-A01	<b>MPU-3076K</b>	1	Outer Shells, Inner Tubes, Bushings	
DEL.	Control Arm Upper-Inner Eccentric Kit Camber adjustment +/- one side only (Single Offset).	<b>MPU-3073K</b>	1	Outer Shells, Inner Tubes, Bushings	
DEL.	Control Arm Upper-Inner Eccentric Kit Camber adjustment +/- both sides (Double Offset).	<b>MPU-3074K</b>	1	Outer Shells, Inner Tubes, Bushings	



## HONDA Accord Euro CL7 Sedan - 6/2003 - 2007

Página 2 (Continúa)









Aplicaci...	Descripción	Referencia	Kits por...	Contenido del Kit	
DEL.	Control Arm Upper-Inner Kit	<b>MPU-3072K</b>	1	Outer Shells, Inner Tubes, Bushings	
DEL.	Steering Rack & Pinion Mount Bushing	<b>MPU-3603K</b>	1	Inner Tubes, Bushings	
DEL.	Subframe to Chassis Mount Bush Kit	<b>MPU-3497K</b>	1	Washers, Bushings	
DEL.	Sway Bar Mount Bushing Measure bar diameter	<b>MPU-3077-__K</b>	1	Bushings	
TRAS.	Complete Kit For Camber Adjustment Offset kit 2 x SPF2589K & 1 x SPF2591K	<b>MPK-094K</b>	1	Outer Shells, Inner Tubes, Bushings	
TRAS.	Control Arm Lower-Inner Bushing Standard bushing	<b>MPU-2588K</b>	1	Bushings, Inner Tubes, Outer Shells	
TRAS.	Control Arm Lower-Inner Eccentric Kit Offset tubes for adjustment	<b>MPU-2589K</b>	1	Bushings, Inner Tubes, Outer Shells	

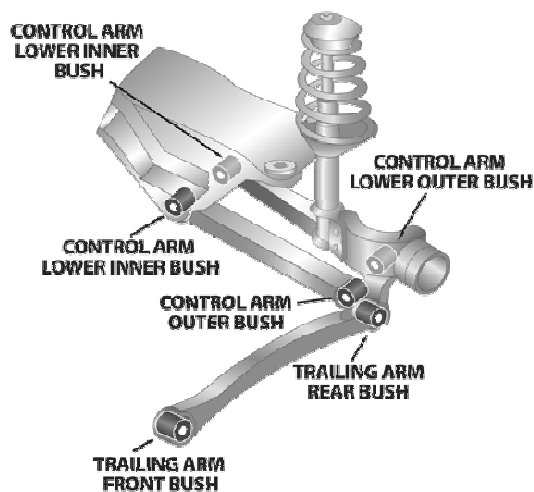
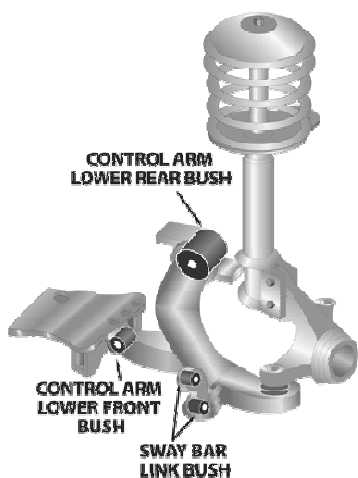

## HONDA Accord Euro CL7 Sedan - 6/2003 - 2007

Página 3 (Continúa)





Aplicaci...	Descripción	Referencia	Kits por...	Contenido del Kit	
TRAS.	Control Arm Lower-Outer Bushing Standard bushing	<b>MPU-2588K</b>	1	Bushings, Inner Tubes, Outer Shells	
TRAS.	Control Arm Upper-Inner Bushing Offset tubes for adjustment	<b>MPU-2589K</b>	1	Bushings, Inner Tubes, Outer Shells	
TRAS.	Control Arm Upper-Inner Kit Standard bushing	<b>MPU-2588K</b>	1	Bushings, Inner Tubes, Outer Shells	
TRAS.	Sway Bar Mount To Chassis Bushing Measure bar diameter, 14,18,19,20 & 22mm available	<b>MPU-2403-__K</b>	1	Bushings	
TRAS.	Toe Control Arm - Inner Bushing Standard bushing	<b>MPU-2590K</b>	1	Bushings, Inner Tubes, Outer Shells	
TRAS.	Toe Control Arm - Outer Bushing Standard bushing	<b>MPU-2590K</b>	1	Bushings, Inner Tubes, Outer Shells	
TRAS.	Toe Control Arm-Outer Eccentric Kit Offset tube for adjustment	<b>MPU-2591K</b>	1	Bushings, Inner Tubes, Outer Shells	

## HONDA Element SUV - 2003 - 2006

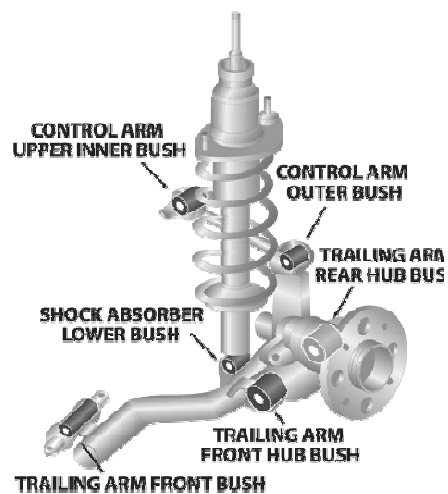
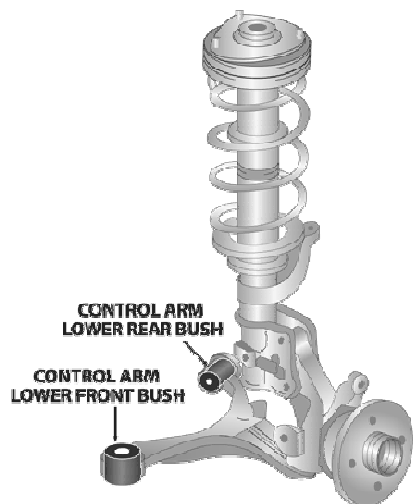
Página 1





Aplicaci...	Descripción	Referencia	Kits por...	Contenido del Kit	
TRAS.	Control Arm Lower-Outer Bushing 2 x 14mm bolts, replaces OE#52365-S6M-004 & 2 x 12mm bolts, replaces OE#52365-S9A-004 or...	MPU-3195K	1	Inner Tubes, Bushings	

## HONDA Odyssey 3rd Generation Wagon - 7/2004 - On

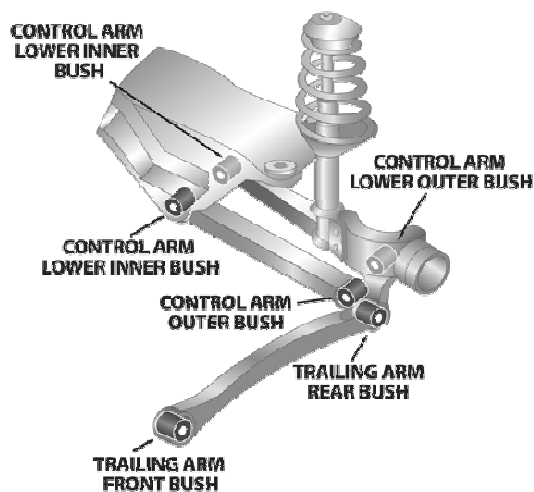
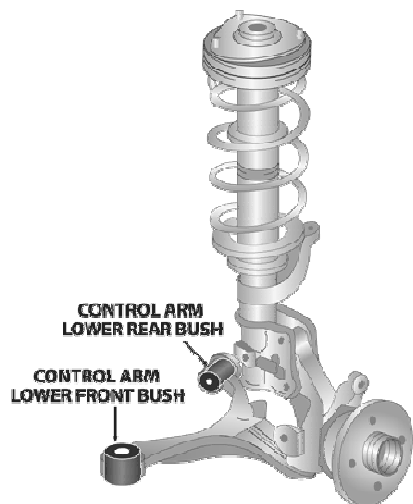
Página 1





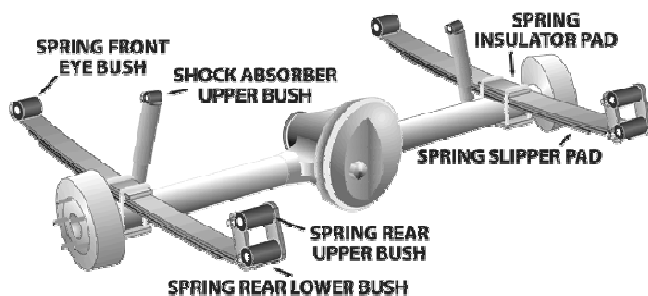
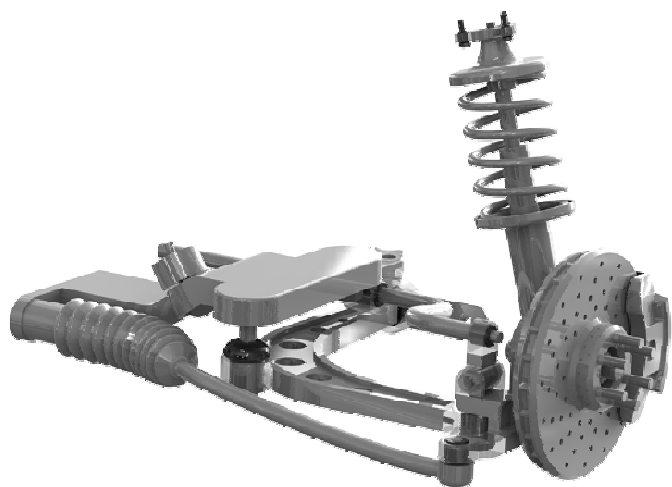

Aplicaci...	Descripción	Referencia	Kits por...	Contenido del Kit	
DEL.	Control Arm Lower-Shock Mount Kit Replaces original part number 51810-SDA-A01	<b>MPU-3076K</b>	1	Outer Shells, Inner Tubes, Bushings	

## HONDA S600 / S800 Classic - 1964 - 1970

Página 1





Aplicaci...	Descripción	Referencia	Kits por...	Contenido del Kit	
DEL.	Sway Bar End Bushing to Strut bar Measure bar diameter 16mm available	MPU-3236-_ _K#R&D	1	Bushings	
DEL.	Sway Bar Mount Bushing Measure sway bar diameter 16mm available	MPU-3235-_ _K#R&D	1	Bushings	
TRAS.	Drive Coupling Bushing	MPU-0775K	2	Inner Tubes, Bushings	

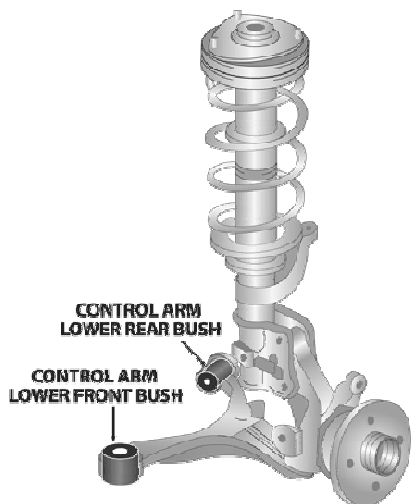

**HONDA Jazz GD - 10/2002 - 9/2008**

Página 1







Aplicaci...	Descripción	Referencia	Kits por...	Contenido del Kit	
DEL.	Control Arm Lower-Inner Rear Kit Standard replacement	<b>MPU-3461K</b>	1	Bushings, Outer Shells, Inner Tubes, Inst Sheet	

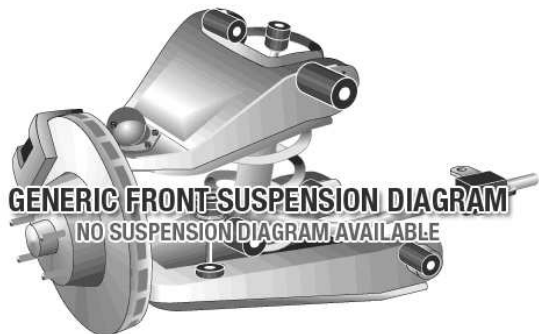

**HONDA Stream 2ND GENERATION - 2007-ON**

Página 1

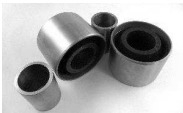

Aplicaci...	Descripción	Referencia	Kits por...	Contenido del Kit	
DEL.	Control Arm Lower Rear Bushing	<b>MPU-3753K</b>	1	Bushings, Outer Shells, Inner Tubes	
DEL.	Control Arm Lower-Front Bushing	<b>MPU-3679K</b>	1	Inner Tubes, Bushings	





## HONDA Integra DC2 & DC4 Vti-R / Type R - 7/1993 - 8/2001

Página 1

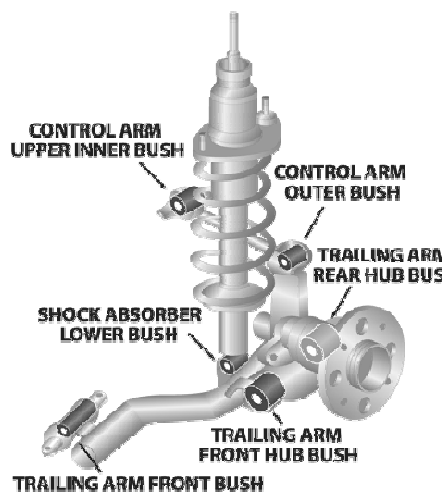
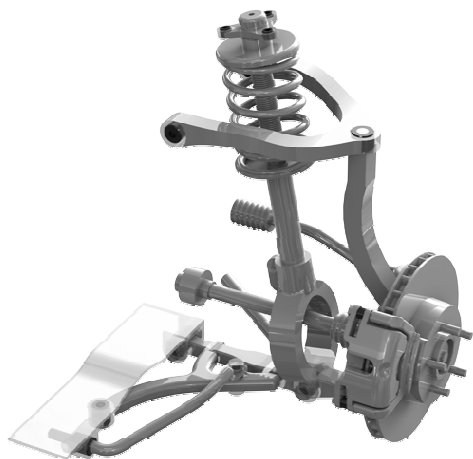

Aplicaci...	Descripción	Referencia	Kits por...	Contenido del Kit	
DEL.	Control Arm Lower Rear Bushing PS increased DS decrease caster (Round style bush)	<b>MPU-1541K</b>	1	Bushings, Inner Tubes	
DEL.	Control Arm Lower Rear Bushing PS & DS standard caster setting (Round style bush)	<b>MPU-1539K</b>	1	Bushings, Inner Tubes	
DEL.	Control Arm Lower Rear Bushing PS increased DS standard caster (Round style bush)	<b>MPU-1540K</b>	1	Inner Tubes, Bushings	
DEL.	Control Arm Lower Rear Bushing PS & DS increased caster (Round style bush)	<b>MPU-1541AK</b>	1	Inner Tubes, Bushings	
DEL.	Control Arm Lower-Inner Front Kit Bush OD 37mm, bolt diameter 14mm	<b>MPU-1525K</b>	1	Bushings, Inner Tubes	
DEL.	Control Arm Upper-Inner Eccentric Kit 34mm OD bush, Camber kit(Fixed 1 degree max offset )	<b>MPU-1941K</b>	1	Inner Tubes, Bushings	
DEL.	Control Arm Upper-Inner Kit 34mm outside diameter bush	<b>MPU-1524K</b>	1	Inner Tubes, Bushings	



## HONDA Integra DC2 & DC4 Vti-R / Type R - 7/1993 - 8/2001

Página 2 (Continúa)

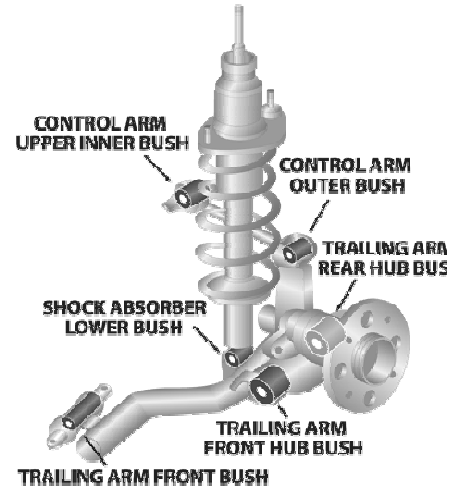
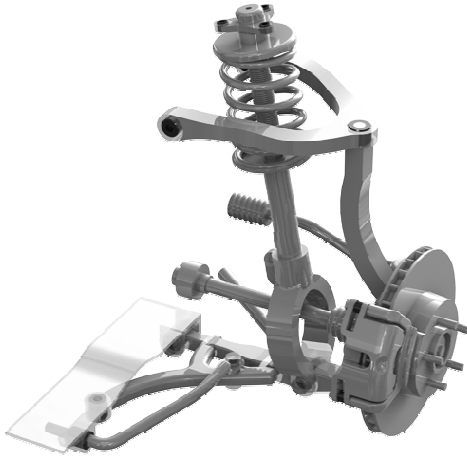





Aplicaci...	Descripción	Referencia	Kits por...	Contenido del Kit	
DEL.	Shock Absorber Lower Bushing	<b>MPU-1527K</b>	1	Bushings, Inner Tubes	
DEL.	Sway Bar Mount To Chassis Bushing Measure bar diameter 24mm available "Type R"	<b>MPU-2256-__K</b>	1	Bushings	
TRAS.	Lateral Arm Front Bushing Inner and outer bushes, Re-use original outer shell	<b>MPU-1940K</b>	1	Inner Tubes, Bushings	
TRAS.	Lateral Arm Rear Inner Bushing Re-use original mount pin bar	<b>MPU-1899K</b>	1	Bushings	
TRAS.	Lateral Arm Rear Outer Bushing	<b>MPU-1861K</b>	1	Inner Tubes, Bushings	
TRAS.	Sway Bar End Link Bushing 1993 - 1996	<b>MPU-1531K</b>	1	Inner Tubes, Bushings	
TRAS.	Sway Bar Mount To Chassis Bushing Measure bar diameter 14,15mm available "NOT suited to Type R"	<b>MPU-1534-__K</b>	1	Bushings	

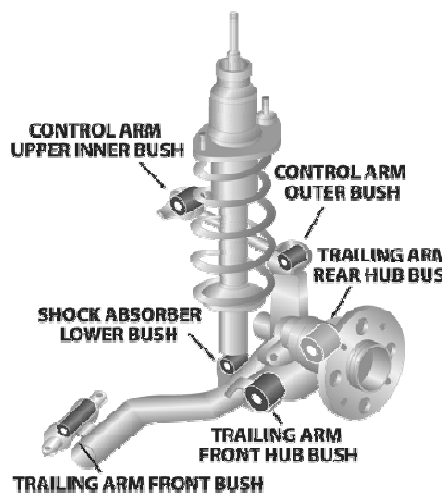
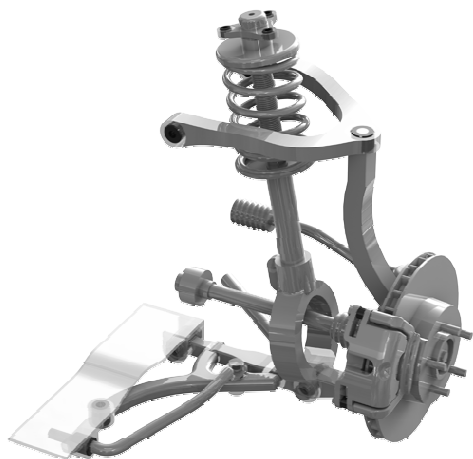

## HONDA Integra DC2 & DC4 Vti-R / Type R - 7/1993 - 8/2001

Página 3 (Continúa)









Aplicaci...	Descripción	Referencia	Kits por...	Contenido del Kit	
TRAS.	Sway Bar Mount To Chassis Bushing Measure bar diameter 20,22,24mm available "Type R"	MPU-2257-__K	1	Bushings	
TRAS.	Trailing Arm Lower Front Bushing Re-use original mount pin 30mm OD, 74mm OD bush	MPU-0807K	1	Bushings	
TRAS.	Trailing Arm Lower Front Bushing Turbo Style Bushing Complete assembly. Replaces SPF0807K	MPU-3495K	1	Outer Shells, Inner Tubes, Bushings	

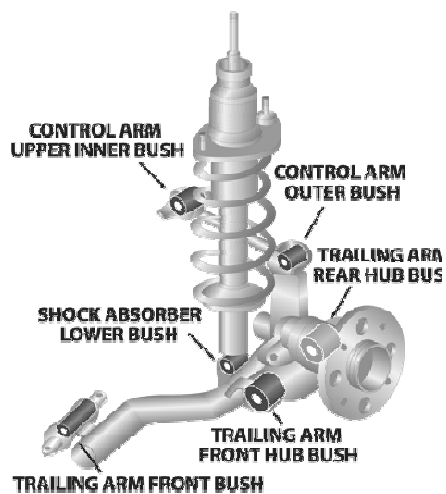
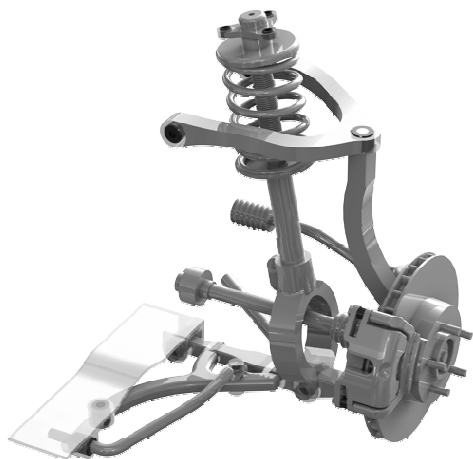

## HONDA Integra DA9 - 6/1989 - 7/1993

Página 1



Aplicaci...	Descripción	Referencia	Kits por...	Contenido del Kit	
DEL.	Control Arm Lower-Inner Bushing Tube ID 10mm, Length 52mm	<b>MPU-2131K</b>	1	Bushings, Inner Tubes	
DEL.	Shock Absorber Lower Bushing	<b>MPU-1527K</b>	1	Bushings, Inner Tubes	
TRAS.	Lateral Arm Upper Rear Inner Bushing Re-use original mount pin bar	<b>MPU-1899K</b>	1	Bushings	
TRAS.	Lateral Arm Upper Rear Outer Bushing	<b>MPU-1861K</b>	1	Inner Tubes, Bushings	
TRAS.	Trailing Arm Lower Front Bushing OE# 52385 SK7N02, Use OE mount pin 38mm OD, 80mm OD bush	<b>MPU-1050K</b>	1	Bushings	



## HONDA Integra DC5 Type R / RSX (Includes Type S) - 9/2001 - ...

Página 1

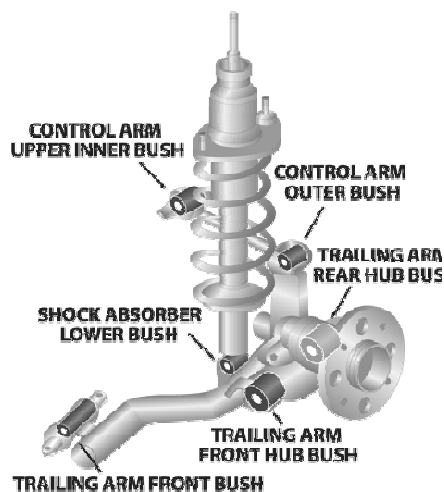
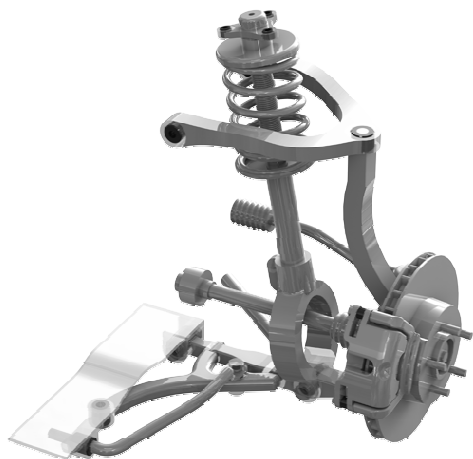







Aplicaci...	Descripción	Referencia	Kits por...	Contenido del Kit	
DEL.	Control Arm Inner-Front & Rear Kit Caster increase kit, 2 x page fitting instruction included in kit.	<b>MPU-2308K</b>	1	Outer Shells, Inner Tubes, Bushings	
DEL.	Control Arm Inner-Front & Rear Kit Standard replacement	<b>MPU-2306K</b>	1	Inst Sheet, Outer Shells, Inner Tubes, Bushings	
DEL.	Control Arm Lower-Inner Front Kit	<b>MPU-2306FK</b>	1	Inst Sheet, Outer Shells, Inner Tubes, Bushings	
DEL.	Control Arm Lower-Inner Rear Kit	<b>MPU-2307K</b>	1	Inner Tubes, Bushings	
DEL.	Sway Bar Mount To Chassis Bushing Measure bar diameter 18,20,22,23,24,27.5 28mm available	<b>MPU-2183-__K</b>	1	Bushings	
F & R	SuperPro Alignment & Enhancement Kit SPF2308Kx1, SPF2318Kx1, SPF3195Kx1, SPF2311Kx1. See any notes listed against...	<b>MPK-129K</b>	1	Outer Shells, Inner Tubes, Bushings	
TRAS.	Control Arm Lower-Inner Rear Kit Replaces OE#52364S6M004	<b>MPU-2318K</b>	1	Outer Shells, Inner Tubes, Bushings	

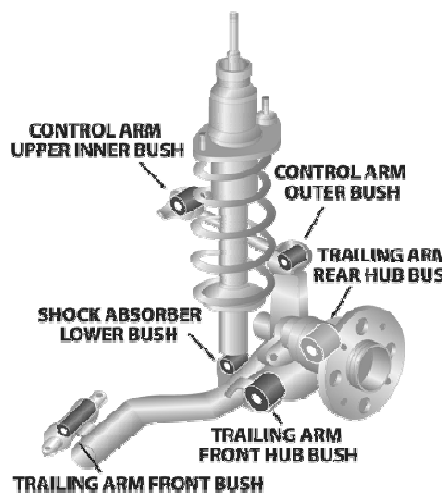
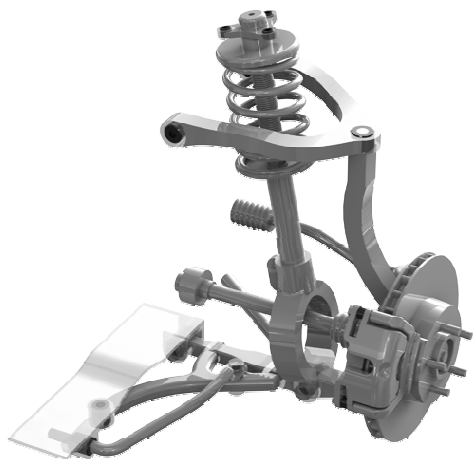

## HONDA Integra DC5 Type R / RSX (Includes Type S) - 9/2001 - ...

Página 2 (Continúa)







Aplicaci...	Descripción	Referencia	Kits por...	Contenido del Kit	
TRAS.	Control Arm Lower-Outer Bushing Up to 2006 Note	<b>MPU-2317K</b>	1	Inner Tubes, Bushings	
TRAS.	Control Arm Upper-Outer Bushing Standard	<b>MPU-2310K</b>	1	Bushings, Inner Tubes	
TRAS.	Control Arm Upper-Outer Bushing Adjustable camber {Increase or Decrease}	<b>MPU-2311K</b>	1	Bushings, Inner Tubes	
TRAS.	Sway Bar Mount To Chassis Bushing Measure bar diameter 19, 22,25mm available	<b>MPU-2184-__K</b>	1	Bushings	

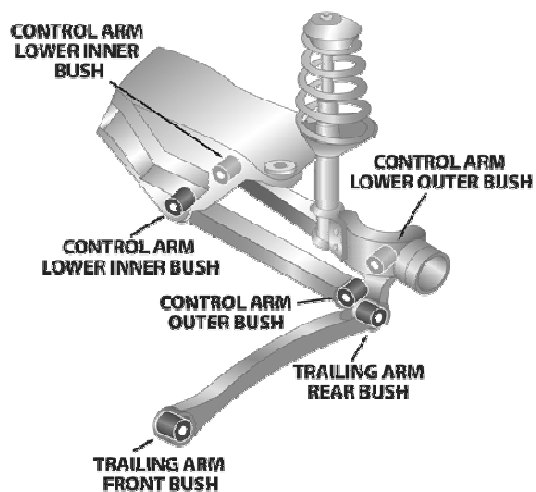
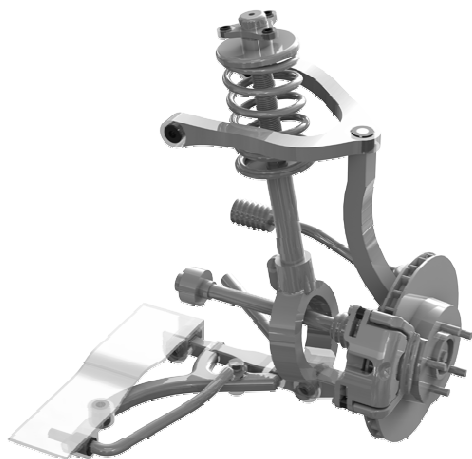

## HONDA Prelude BB2 Coupe 2WS & 4WS - 12/1991 - 12/1996

Página 1









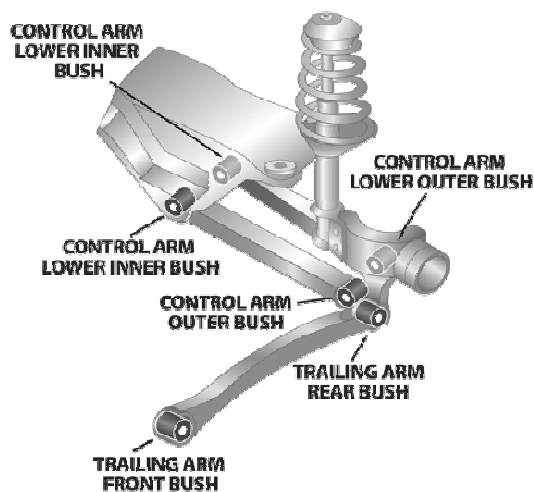
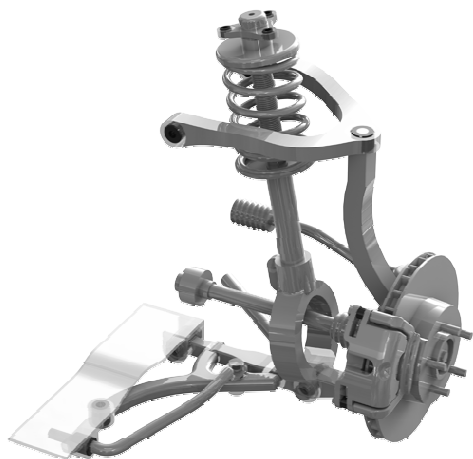

Aplicaci...	Descripción	Referencia	Kits por...	Contenido del Kit	
DEL.	Control Arm Lower-Inner Bushing Tube ID 12mm, Length 56mm	<b>MPU-1292K</b>	1	Bushings, Inner Tubes	
DEL.	Control Arm Lower-Shock Mount Kit	<b>MPU-1294K</b>	1	Bushings, Inner Tubes, Washers	



## HONDA Prelude BA4 Coupe 2WS & 4WS - 10/1987 - 11/1991

Página 1



Aplicaci...	Descripción	Referencia	Kits por...	Contenido del Kit	
DEL.	Control Arm Lower-Inner Bushing Tube ID 10mm, Length 52mm	<b>MPU-2131K</b>	1	Bushings, Inner Tubes	
DEL.	Control Arm Lower-Shock Mount Kit	<b>MPU-2132K</b>	1	Washers, Inner Tubes, Bushings	
DEL.	Control Arm Upper-Inner Kit Must remove original shell	<b>MPU-2061K</b>	1	Washers, Inner Tubes, Bushings	
DEL.	Strut Bar To Chassis Mount Kit Re-use original tubes & washers	<b>MPU-2129K</b>	1	Bushings	
DEL.	Sway Bar Link Bushing Kit	<b>MPU-0904K</b>	1	Bushings	
DEL.	Sway Bar Mount To Chassis Bushing Measure bar diameter 24mm & 25mm available	<b>MPU-0265-__K</b>	1	Bushings	
TRAS.	Control Arm Lower-Inner Bushing	<b>MPU-2133K</b>	1	Inner Tubes, Bushings	





## HONDA Prelude BA4 Coupe 2WS & 4WS - 10/1987 - 11/1991

Página 2 (Continúa)

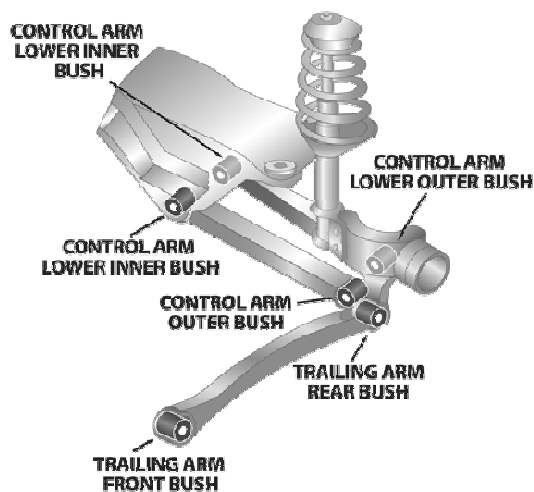
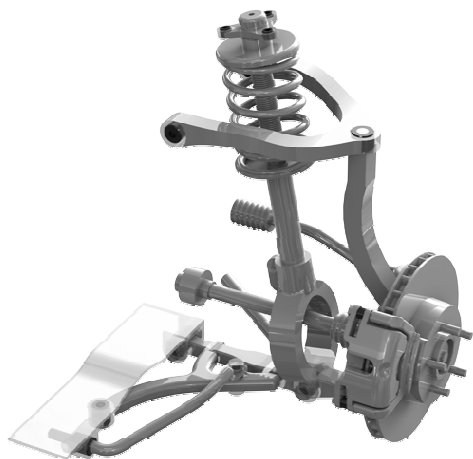







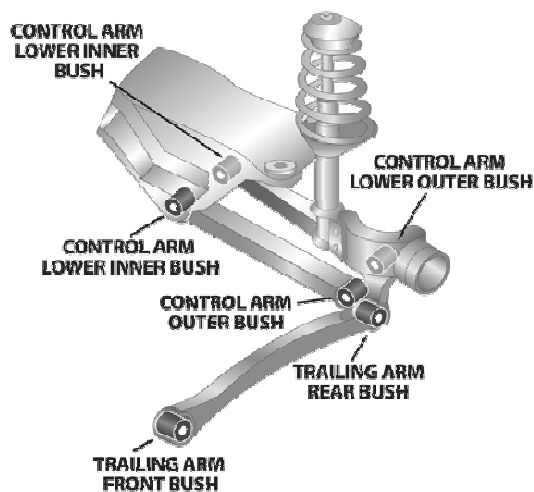
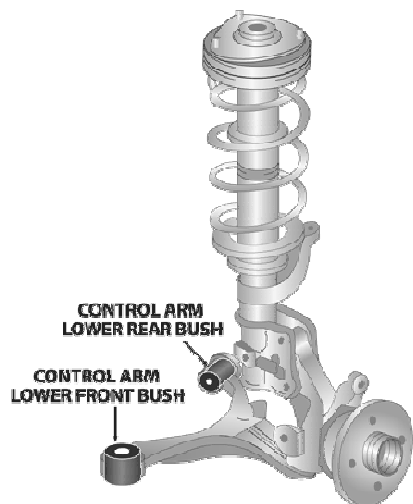

Aplicaci...	Descripción	Referencia	Kits por...	Contenido del Kit	
TRAS.	Control Arm Lower-Shock Mount Kit	<b>MPU-2132K</b>	1	Washers, Inner Tubes, Bushings	
TRAS.	Control Arm Upper-Inner Kit Must remove original shell	<b>MPU-2061K</b>	1	Washers, Inner Tubes, Bushings	
TRAS.	Strut Bar To Chassis Mount Kit	<b>MPU-1767K</b>	1	Bushings, Inner Tubes	
TRAS.	Sway Bar End Link Bushing	<b>MPU-1531K</b>	1	Inner Tubes, Bushings	
TRAS.	Sway Bar Link Lower Bushing	<b>MPU-0904-4K</b>	1	Bushings	
TRAS.	Sway Bar Mount To Chassis Bushing Measure bar diameter 16,17,18,20,22,24mm available	<b>MPU-0266-__K</b>	1	Bushings	

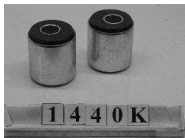

## HYUNDAI Tiburon RD & RD2 (FX Coupe 2 door) - 1996 - 2001

Página 1







Aplicaci...	Descripción	Referencia	Kits por...	Contenido del Kit	
DEL.	Control Arm Lower-Inner Front Kit	<b>MPU-1870K</b>	1	Bushings, Inner Tubes	
DEL.	Control Arm Lower-Inner Rear Kit PS & DS standard	<b>MPU-1440K</b>	1	Bushings, Inner Tubes, Outer Shells	
DEL.	Control Arm Lower-Inner Rear Kit PS increase DS standard caster setting	<b>MPU-1441K</b>	1	Bushings, Inner Tubes, Outer Shells	
DEL.	Control Arm Lower-Inner Rear Kit PS & DS increase caster	<b>MPU-1442AK</b>	1	Bushings, Inner Tubes, Outer Shells	
DEL.	Control Arm Lower-Inner Rear Kit PS increased DS increase / decrease caster	<b>MPU-1442K</b>	1	Bushings, Inner Tubes, Outer Shells	
DEL.	Sway Bar Mount To Chassis Bushing Measure sway bar diameter 24,25mm available	<b>MPU-1872-__K</b>	1	Bushings	
F & R	Complete Sports Performance Kit No sway bar bushes included in kit	<b>MPK-081K</b>	1		

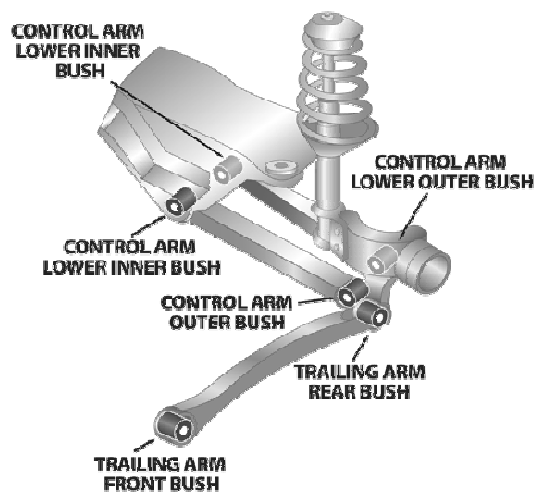
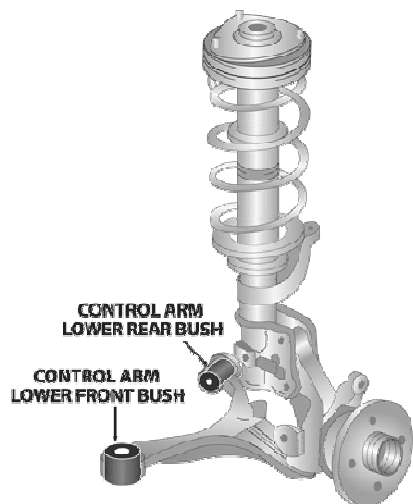

## HYUNDAI Tiburon RD & RD2 (FX Coupe 2 door) - 1996 - 2001

Página 2 (Continúa)









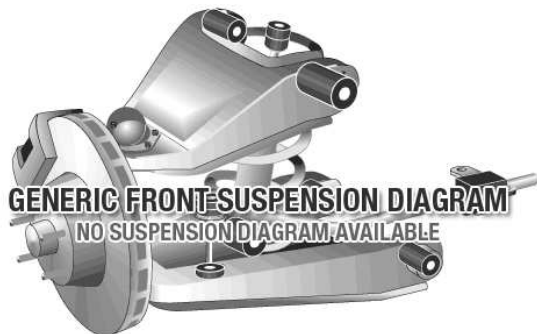

Aplicaci...	Descripción	Referencia	Kits por...	Contenido del Kit	
TRAS.	Control Arm-Front Inner & Outer Kit	<b>MPU-0825K</b>	1	Inner Tubes, Bushings	
TRAS.	Control Arm-Rear Inner & Outer Kit	<b>MPU-0825K</b>	1	Inner Tubes, Bushings	
TRAS.	Sway Bar Mount To Chassis Bushing Measure sway bar diameter 14,17mm available	<b>MPU-1871-__K</b>	1	Bushings	
TRAS.	Trailing Arm - Bushing Kit	<b>MPU-0823K</b>	1	Inner Tubes, Bushings	



## HYUNDAI Tiburon GK - 2002 - 2010

Página 1









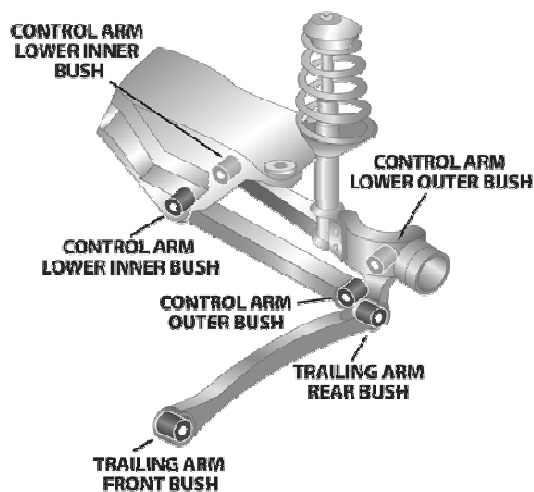
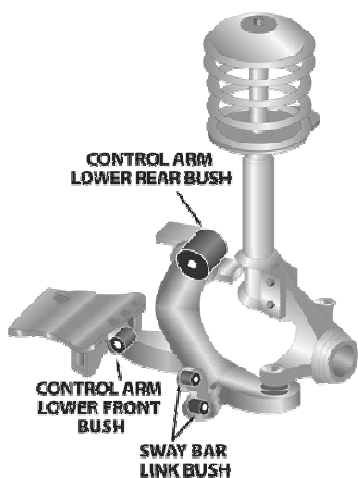

Aplicaci...	Descripción	Referencia	Kits por...	Contenido del Kit	
DEL.	Control Arm Lower-Inner Rear Eccentric 2 x Offset bushings.	<b>MPU-3113K</b>	1	Outer Shells, Inner Tubes, Bushings	
DEL.	Control Arm Lower-Inner Rear Eccentric 1 x Standard & 1 x offset.	<b>MPU-3134K</b>	1	Outer Shells, Inner Tubes, Bushings	
DEL.	Control Arm Lower-Inner Rear Eccentric 2 x Offset Bushings.	<b>MPU-3135K</b>	1	Outer Shells, Inner Tubes, Bushings	
DEL.	Control Arm Lower-Inner Rear Kit Standard replacement.	<b>MPU-3111K</b>	1	Outer Shells, Inner Tubes, Bushings	
DEL.	Control Arm Lower-Inner Rear Kit Standard replacement.	<b>MPU-3133K</b>	1	Outer Shells, Inner Tubes, Bushings	
DEL.	Control Arm Lower-Inner Rear Eccentric 1 x Offset & 1 x Standard bushing.	<b>MPU-3112K</b>	1	Outer Shells, Inner Tubes, Bushings	



## HYUNDAI S Coupe Coupe & Turbo Coupe - 6/1990 - 12/1995

Página 1

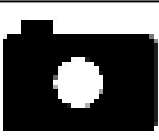



Aplicaci...	Descripción	Referencia	Kits por...	Contenido del Kit	
DEL.	Control Arm Lower-Front Bushing	<b>MPU-0948K</b>	1	Inner Tubes, Bushings	
DEL.	Control Arm Lower Rear Bushing PS & DS standard	<b>MPU-0949K</b>	1	Bushings	
DEL.	Control Arm Lower Rear Bushing PS increased DS standard caster	<b>MPU-0950K</b>	1	Bushings	
DEL.	Control Arm Lower Rear Bushing PS increased DS decrease caster	<b>MPU-0951K</b>	1	Bushings	
DEL.	Sway Bar Link Bushing Kit	<b>MPU-0903K</b>	1	Bushings	
DEL.	Sway Bar Mount To Chassis Bushing Measure bar diameter 18mm available	<b>MPU-1422-__K</b>	1	Bushings	
TRAS.	Beam to Body Bushing	<b>MPU-1848K</b>	1	Bushings	

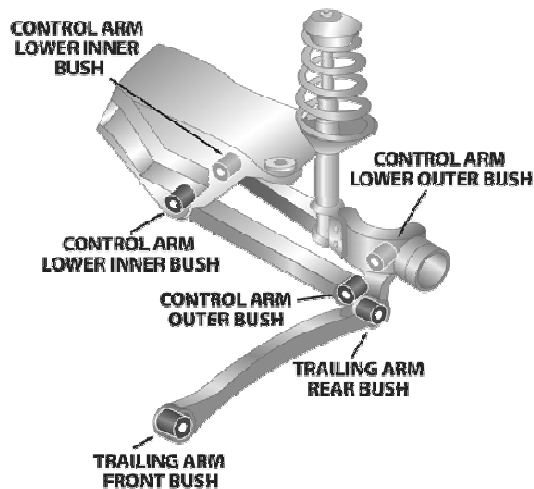
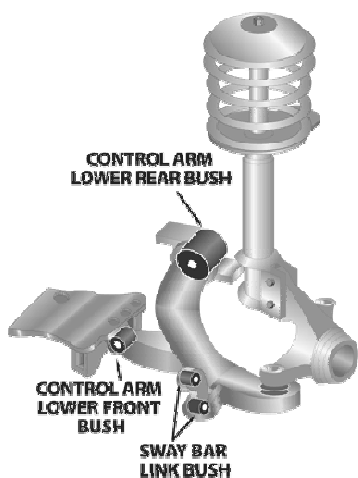

**HYUNDAI Accent LC, Sedan & Hatch - 2000 - 2005**

Página 1







Aplicaci...	Descripción	Referencia	Kits por...	Contenido del Kit	
DEL.	Sway Bar Mount Bushing Measure bar diameter 18,20,22mm available	MPU-2683-__K	1	Bushings	



**HYUNDAI Accent MC, Sedan & Hatch - 2006 - 2011**

Página 1







Aplicaci...	Descripción	Referencia	Kits por...	Contenido del Kit	
DEL.	Control Arm Lower-Inner Rear Eccentric PS & DS increase or decrease caster	<b>MPU-2102K</b>	1	Outer Shells, Inner Tubes, Bushings	
DEL.	Control Arm Lower-Inner Rear Eccentric PS increase / DS standard caster	<b>MPU-2101K</b>	1	Outer Shells, Inner Tubes, Bushings	
DEL.	Control Arm Lower-Inner Rear Kit Standard Settings.	<b>MPU-2100K</b>	1	Outer Shells, Inner Tubes, Bushings	

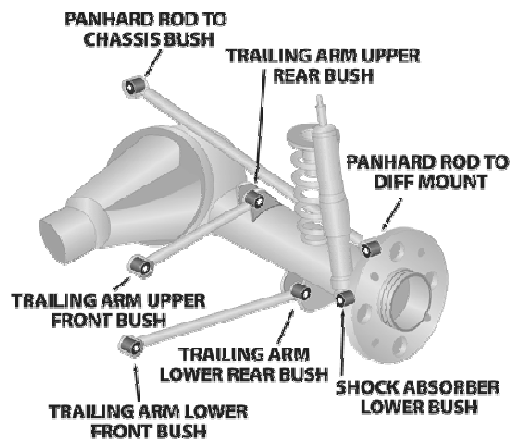
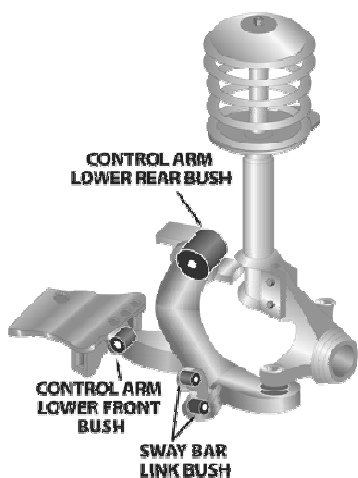

## HYUNDAI Santa Fe SM, 4WD Wagon - 2000 - 3/2006

Página 1



Aplicaci...	Descripción	Referencia	Kits por...	Contenido del Kit	
DEL.	Control Arm Lower Rear Bushing Standard	<b>MPU-1944K</b>	1	Bushings, Inner Tubes, Outer Shells	
DEL.	Control Arm Lower Rear Bushing PS increase DS standard caster	<b>MPU-1945K</b>	1	Bushings, Inner Tubes, Outer Shells	
DEL.	Control Arm Lower Rear Bushing PS increase DS increase / decrease caster	<b>MPU-1946K</b>	1	Bushings, Inner Tubes, Outer Shells	









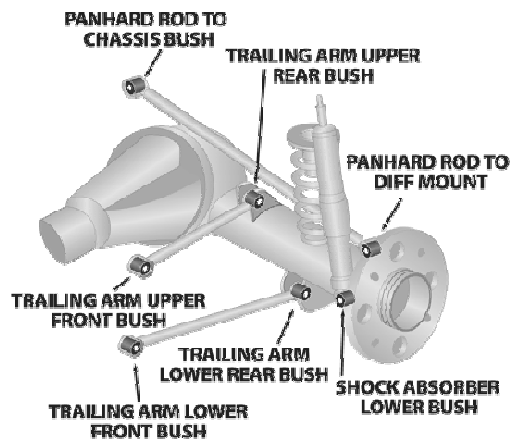
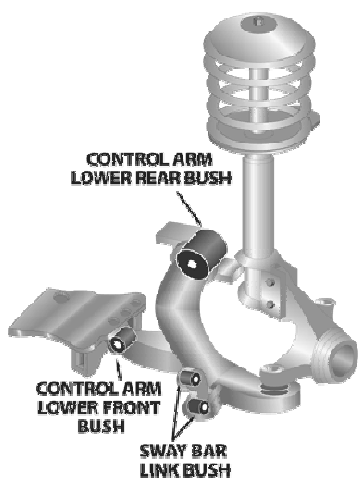

## HYUNDAI Santa Fe CM, 4WD Wagon - 04/2006 - 2012

Página 1





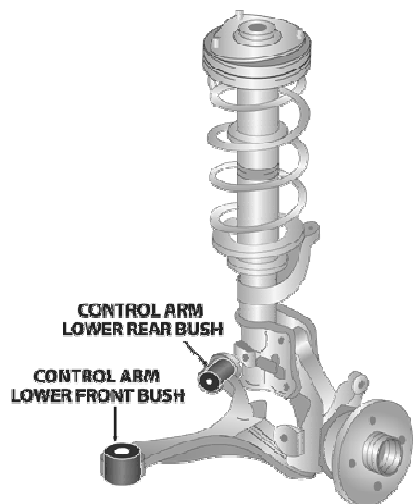

Aplicaci...	Descripción	Referencia	Kits por...	Contenido del Kit	
DEL.	Control Arm Lower-Inner Rear Eccentric PS & DS increase or decrease caster	<b>MPU-2102K</b>	1	Outer Shells, Inner Tubes, Bushings	
DEL.	Control Arm Lower-Inner Rear Eccentric PS increase / DS standard caster	<b>MPU-2101K</b>	1	Outer Shells, Inner Tubes, Bushings	
DEL.	Control Arm Lower-Inner Rear Kit Standard Settings	<b>MPU-2100K</b>	1	Outer Shells, Inner Tubes, Bushings	
DEL.	Sway Bar Mount Bushing Measure bar diameter as 27 & 30mm are available	<b>MPU-2878-__K</b>	1	Bushings	
TRAS.	Sway Bar Mount Bushing Measure bar diameter as 15 & 20mm are available	<b>MPU-2879-__K</b>	1	Bushings	

## HYUNDAI Getz TB 4 & 5 Door - 03/2003 - On

Página 1







Aplicaci...	Descripción	Referencia	Kits por...	Contenido del Kit	
DEL.	Control Arm Lower-Inner Rear Eccentric 1 x Standard & 1 x offset; Replaces OE# 54584-1C300.	<b>MPU-3134K</b>	1	Outer Shells, Inner Tubes, Bushings	
DEL.	Control Arm Lower-Inner Rear Eccentric 2 x Offset Bushings; Replaces OE# 54584-1C300.	<b>MPU-3135K</b>	1	Outer Shells, Inner Tubes, Bushings	
DEL.	Control Arm Lower-Inner Rear Kit Standard replacement; Replaces OE# 54584-1C300.	<b>MPU-3133K</b>	1	Outer Shells, Inner Tubes, Bushings	
DEL.	Sway Bar Mount Bushing Measure bar diameter 20mm available	<b>MPU-3190-__K</b>	1	Bushings	

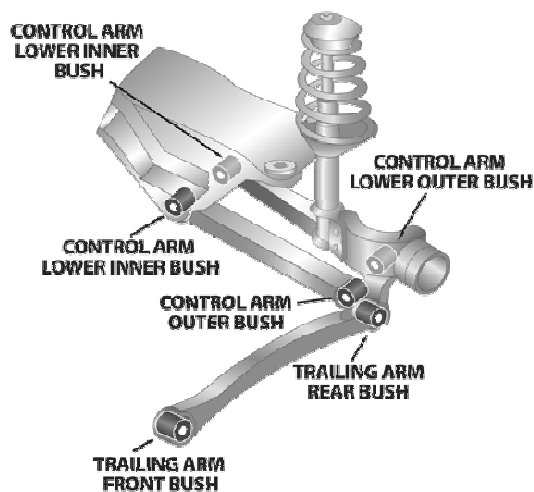
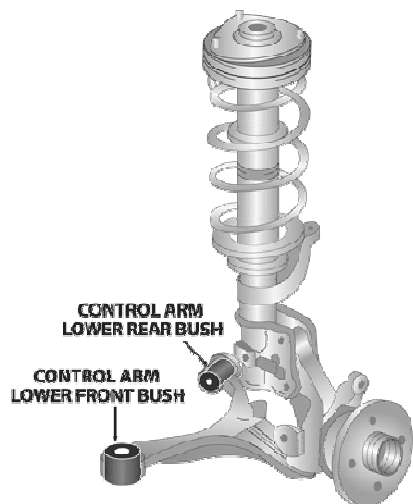

## HYUNDAI XG30 / 300 / 350 Grandeur Third Generation - 1998...

Página 1









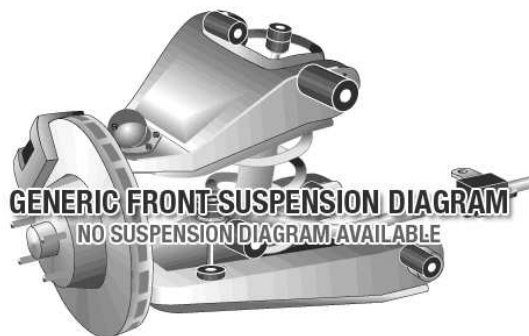
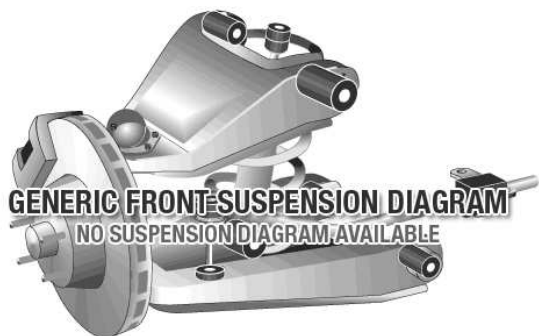

Aplicaci...	Descripción	Referencia	Kits por...	Contenido del Kit	
DEL.	Control Arm Lower-Inner Rear Eccentric PS & DS increase or decrease caster	<b>MPU-2102K</b>	1	Outer Shells, Inner Tubes, Bushings	
DEL.	Control Arm Lower-Inner Rear Eccentric PS increase / DS standard caster	<b>MPU-2101K</b>	1	Outer Shells, Inner Tubes, Bushings	
DEL.	Control Arm Lower-Inner Rear Kit Standard Settings	<b>MPU-2100K</b>	1	Outer Shells, Inner Tubes, Bushings	



## HYUNDAI Elantra XD (Mk3) - 2000 - 2006

Página 1





Aplicaci...	Descripción	Referencia	Kits por...	Contenido del Kit	
DEL.	Control Arm Lower-Inner Rear Eccentric 1 x Offset & 1 x Standard bushing; To suit 60mm diameter housing.	<b>MPU-3112K</b>	1	Outer Shells, Inner Tubes, Bushings	
DEL.	Control Arm Lower-Inner Rear Eccentric 2 x Offset bushing; To suit 60mm diameter housing.	<b>MPU-3113K</b>	1	Outer Shells, Inner Tubes, Bushings	
DEL.	Control Arm Lower-Inner Rear Eccentric 1 x Standard & 1 x offset.	<b>MPU-3134K</b>	1	Outer Shells, Inner Tubes, Bushings	
DEL.	Control Arm Lower-Inner Rear Eccentric 2 x Offset Bushings.	<b>MPU-3135K</b>	1	Outer Shells, Inner Tubes, Bushings	
DEL.	Control Arm Lower-Inner Rear Kit Standard replacement; To suit 60mm diameter housing.	<b>MPU-3111K</b>	1	Outer Shells, Inner Tubes, Bushings	
DEL.	Control Arm Lower-Inner Rear Kit Standard replacement.	<b>MPU-3133K</b>	1	Outer Shells, Inner Tubes, Bushings	
TRAS.	Trailing Arm Lower Front Bushing	<b>MPU-0907K</b>	1	Inner Tubes, Bushings	 0907K

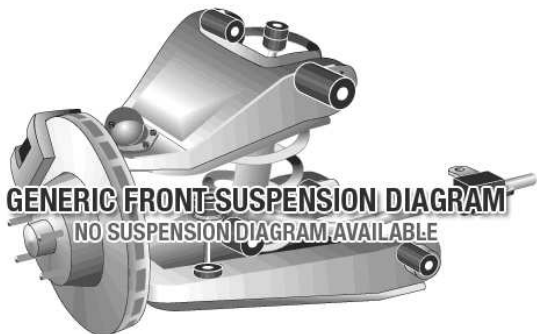

**HYUNDAI Elantra XD (Mk3) - 2000 - 2006**

Página 2 (Continúa)



Aplicaci...	Descripción	Referencia	Kits por...	Contenido del Kit	
TRAS.	Trailing Arm Lower Rear Bushing	<b>MPU-0906K</b>	1	Inner Tubes, Bushings	



## HYUNDAI Elantra HD (Mk4) - 2006 - 2010

Página 1

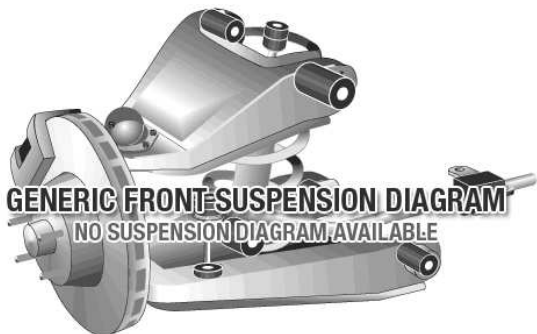







Aplicaci...	Descripción	Referencia	Kits por...	Contenido del Kit	
DEL.	Control Arm Lower-Front Bushing Standard Settings.	<b>MPU-2100K</b>	1	Outer Shells, Inner Tubes, Bushings	
DEL.	Control Arm Lower-Front Bushing Single Offset; PS increase / DS standard caster.	<b>MPU-2101K</b>	1	Outer Shells, Inner Tubes, Bushings	
DEL.	Control Arm Lower-Front Bushing Double Offset; PS & DS increase or decrease caster.	<b>MPU-2102K</b>	1	Outer Shells, Inner Tubes, Bushings	
TRAS.	Trailing Arm - Bushing Kit	<b>MPU-0823K</b>	1	Inner Tubes, Bushings	



## HYUNDAI Elantra MD - 2011 - on

Página 1









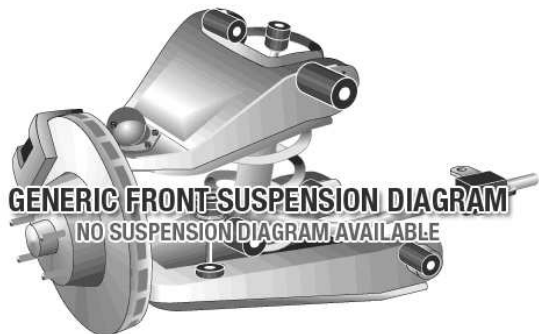

Aplicaci...	Descripción	Referencia	Kits por...	Contenido del Kit	
DEL.	Control Arm Lower-Front Bushing	<b>MPU-3933K</b>	1	Inner Tubes, Bushings	
DEL.	Control Arm Lower-Inner Rear Eccentric Single Offset; PS increase / DS standard caster.	<b>MPU-2101K</b>	1	Outer Shells, Inner Tubes, Bushings	
DEL.	Control Arm Lower-Inner Rear Eccentric Double Offset; PS & DS increase or decrease caster.	<b>MPU-2102K</b>	1	Outer Shells, Inner Tubes, Bushings	
DEL.	Control Arm Lower-Inner Rear Kit Standard Settings.	<b>MPU-2100K</b>	1	Outer Shells, Inner Tubes, Bushings	
DEL.	Sway Bar Mount To Chassis Bushing Measure bar diameter as 15,20,27mm are available	<b>MPU-2879-__K</b>	1	Bushings	



## HYUNDAI iLoad 2nd Gen - 2007 - Current

Página 1



Aplicaci...	Descripción	Referencia	Kits por...	Contenido del Kit	
DEL.	Control Arm Lower Rear Bushing Standard Replacement Kit O.E# 54584-4H000	<b>MPU-3776K</b>	1	Outer Shells, Inner Tubes, Bushings	 SPF3776K
DEL.	Control Arm Lower-Front Bushing	<b>MPU-3777K</b>	1	Inner Tubes, Bushings	 SPF3777K
DEL.	Control Arm Lower-Inner Rear Eccentric Single Offset Bush Kit.	<b>MPU-3808K</b>	1	Outer Shells, Inner Tubes, Bushings	 SPF3808K
DEL.	Control Arm Lower-Inner Rear Eccentric Double Offset Bush Kit.	<b>MPU-3809K</b>	1	Outer Shells, Inner Tubes, Bushings	 SPF3809K
DEL.	Steering Rack & Pinion Mount Bushing	<b>MPU-2992K</b>	1	Inner Tubes, Bushings	
DEL.	Sway Bar Mount To Chassis Bushing Measure bar diameter as 27 & 30mm are available.	<b>MPU-2878-__K</b>	1	Bushings	 SPF2878K
TRAS.	Spring Front Eye Bushing	<b>MPU-3779K</b>	1	Bushings, Inner Tubes	 SPF3779K





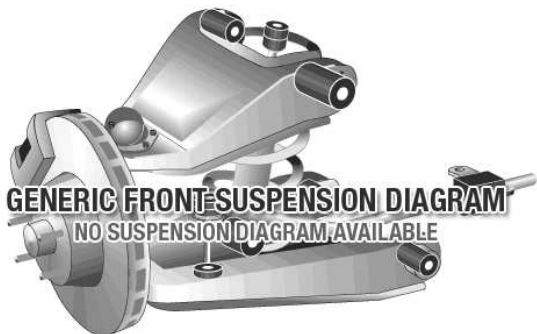

**HYUNDAI iLoad 2nd Gen - 2007 - Current**

Página 2 (Continúa)









Aplicaci...	Descripción	Referencia	Kits por...	Contenido del Kit	
TRAS.	Spring Rear Bushing All	<b>MPU-3780K</b>	1	Bushings	 SPF3780K

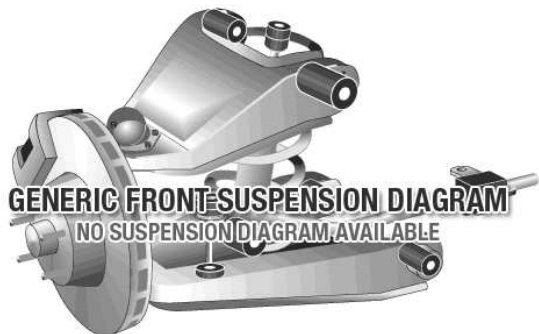

**HYUNDAI Terracan - 2001 - 2007**

Página 1







Aplicaci...	Descripción	Referencia	Kits por...	Contenido del Kit	
DEL.	Control Arm Lower Rear Bushing	<b>MPU-3844K</b>	1	Bushings, Inner Tubes	 SPF3844K
DEL.	Control Arm Upper-Inner Bushing	<b>MPU-3843K</b>	1	Inner Tubes, Bushings	 SPF3843K
TRAS.	Panhard Rod To Chassis Mount Kit	<b>MPU-3842K</b>	1	Bushings, Inner Tubes	 SPF3842K
TRAS.	Trailing Arm - Bushing Kit	<b>MPU-3841K</b>	1	Bushings, Inner Tubes	 SPF3841K

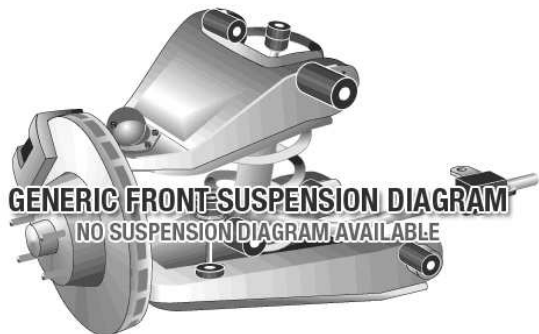

## HYUNDAI Tucson 1st GEN - 2004 - 2009

Página 1









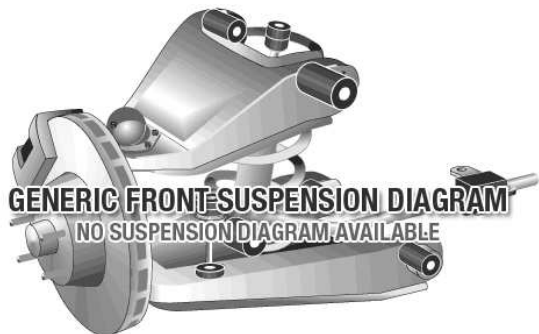

Aplicaci...	Descripción	Referencia	Kits por...	Contenido del Kit	
DEL.	Control Arm Lower-Inner Rear Eccentric PS & DS increase or decrease caster	<b>MPU-2102K</b>	1	Outer Shells, Inner Tubes, Bushings	
DEL.	Control Arm Lower-Inner Rear Eccentric PS increase / DS standard caster	<b>MPU-2101K</b>	1	Outer Shells, Inner Tubes, Bushings	
DEL.	Control Arm Lower-Inner Rear Kit Standard Settings	<b>MPU-2100K</b>	1	Outer Shells, Inner Tubes, Bushings	



## HYUNDAI Veloster FS (First Gen.) - 2012 - on

Página 1







Aplicaci...	Descripción	Referencia	Kits por...	Contenido del Kit	
DEL.	Control Arm Lower-Inner Rear Eccentric Double Offset; PS & DS increase or decrease caster.	<b>MPU-2102K</b>	1	Outer Shells, Inner Tubes, Bushings	
DEL.	Control Arm Lower-Front Bushing	<b>MPU-3933K</b>	1	Inner Tubes, Bushings	
DEL.	Control Arm Lower-Inner Rear Eccentric Single Offset; PS increase / DS standard caster.	<b>MPU-2101K</b>	1	Outer Shells, Inner Tubes, Bushings	
DEL.	Control Arm Lower-Inner Rear Kit Standard Settings.	<b>MPU-2100K</b>	1	Outer Shells, Inner Tubes, Bushings	
DEL.	Engine Steady Bushing	<b>MPU-3936K</b>	1	Bushings	
DEL.	Engine Steady Bushing	<b>MPU-3937K</b>	1	Inner Tubes, Bushings	
DEL.	Sway Bar Mount To Chassis Bushing Measure bar diameter as 15,20,27mm are available	<b>MPU-2879-__K</b>	1	Bushings	

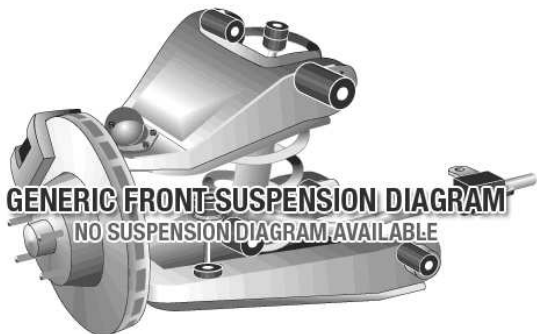

## HYUNDAI Veloster FS (First Gen.) - 2012 - on

Página 2 (Continúa)









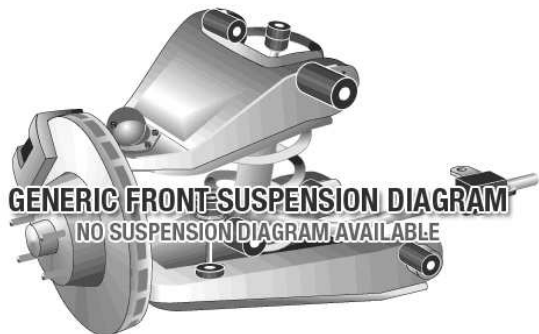

Aplicaci...	Descripción	Referencia	Kits por...	Contenido del Kit	
F & R	Vehicle Master Kit This kit contains - SPF3933K x 1, SPF2102K x 1, SPF3934K x 1	<b>MPK-182K</b>	1	Inner Tubes, Bushings	
TRAS.	Beam Axle Pivot Bushing	<b>MPU-3934K</b>	1	Inner Tubes, Bushings	



## HYUNDAI iMax 2nd Gen - 2008 - Current

Página 1



Aplicaci...	Descripción	Referencia	Kits por...	Contenido del Kit	
DEL.	Control Arm Lower Rear Bushing Standard Replacement Kit.	<b>MPU-3776K</b>	1	Outer Shells, Inner Tubes, Bushings	 SPF3776K
DEL.	Control Arm Lower-Front Bushing	<b>MPU-3777K</b>	1	Inner Tubes, Bushings	 SPF3777K
DEL.	Control Arm Lower-Inner Rear Eccentric Single Offset Bush Kit.	<b>MPU-3808K</b>	1	Outer Shells, Inner Tubes, Bushings	 SPF3808K
DEL.	Control Arm Lower-Inner Rear Eccentric Double Offset Bush Kit.	<b>MPU-3809K</b>	1	Outer Shells, Inner Tubes, Bushings	 SPF3809K
DEL.	Steering Rack & Pinion Mount Bushing	<b>MPU-2992K</b>	1	Inner Tubes, Bushings	
DEL.	Sway Bar Mount To Chassis Bushing Measure bar diameter as 27 & 30mm are available.	<b>MPU-2878-__K</b>	1	Bushings	 SPF2878K



## HYUNDAI Excel / Pony / Accent X3 ( Modern Shape ) - ...

Página 1

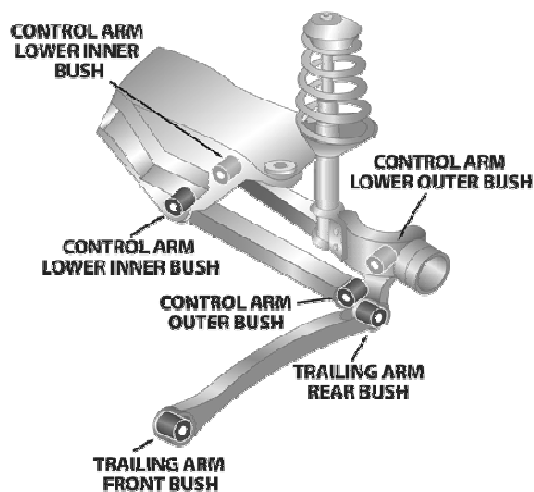
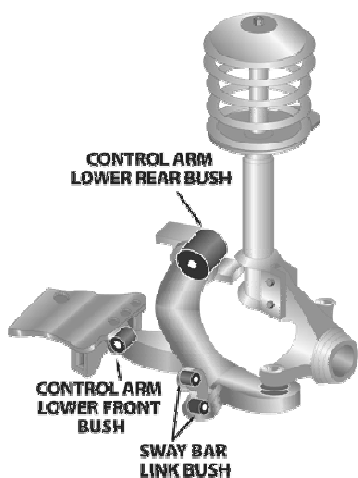







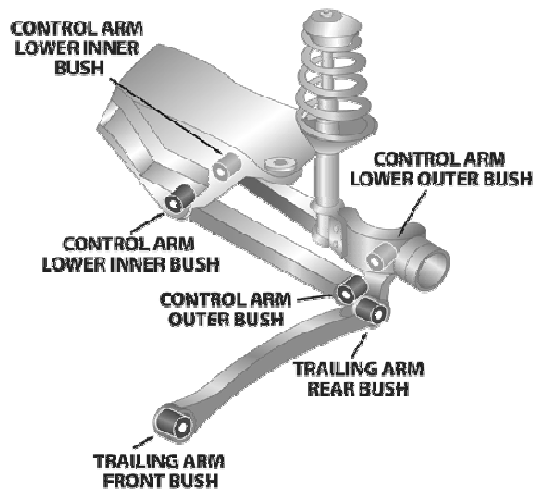
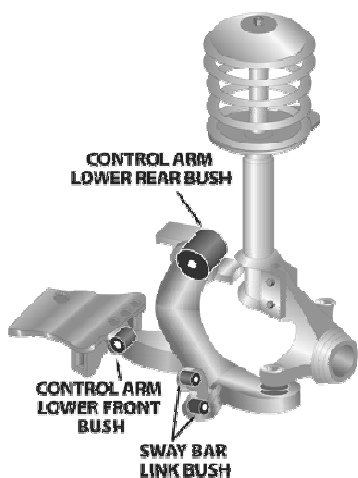

Aplicaci...	Descripción	Referencia	Kits por...	Contenido del Kit	
DEL.	Control Arm Lower Rear Bushing PS & DS standard	<b>MPU-1195K</b>	1	Bushings, Inner Tubes	
DEL.	Control Arm Lower Rear Bushing PS increased DS standard caster	<b>MPU-1196K</b>	1	Bushings, Inner Tubes	
DEL.	Control Arm Lower Rear Bushing PS & DS increased caster	<b>MPU-1197AK</b>	1	Bushings, Inner Tubes	
DEL.	Control Arm Lower Rear Bushing PS increased DS decrease caster	<b>MPU-1197K</b>	1	Inner Tubes, Bushings	
DEL.	Control Arm Lower-Front Bushing	<b>MPU-1126K</b>	1	Inner Tubes, Bushings	
DEL.	Sway Bar Link Bushing Kit	<b>MPU-0903K</b>	1	Bushings	
DEL.	Sway Bar Link Rod Kit Heavy duty rod & bushings kit	<b>MPU-2714K</b>	1	Nuts, Rods, Washers, Bushings	



## HYUNDAI Excel / Pony / Accent X3 ( Modern Shape ) - ...

Página 2 (Continúa)



Aplicaci...	Descripción	Referencia	Kits por...	Contenido del Kit	
DEL.	Sway Bar Mount To Chassis Bushing Measure bar diameter 20,21,22,24mm available	<b>MPU-1283-__K</b>	1	Bushings	
F & R	Complete Sports Performance Kit No sway bar bushes included in kit	<b>MPK-078K</b>	1		
TRAS.	Control Arm Lower-Inner & Outer Kit	<b>MPU-1867K</b>	2	Inner Tubes, Bushings	
TRAS.	Sway Bar Link Bushing Kit	<b>MPU-0903K</b>	1	Bushings	
TRAS.	Sway Bar Mount To Chassis Bushing Measure bar diameter 15,16,21,22,24mm available	<b>MPU-1284-__K</b>	1	Bushings	
TRAS.	Trailing Arm Lower Bushing All	<b>MPU-1866K</b>	1	Bushings, Inner Tubes	









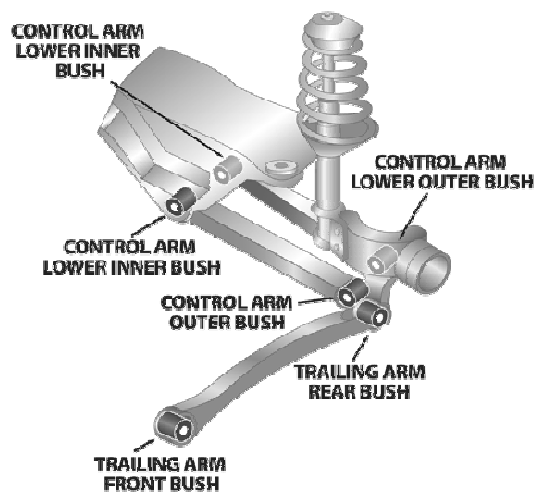
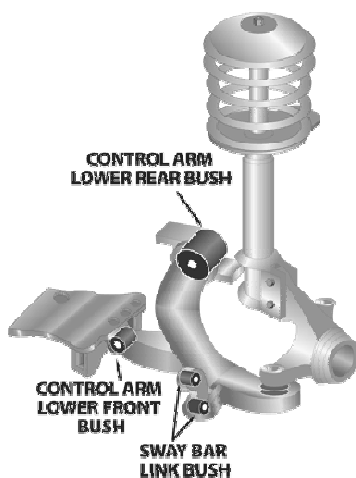



## HYUNDAI Lantra J1 GL Sedan - 5/1991 - 8/1995

Página 1









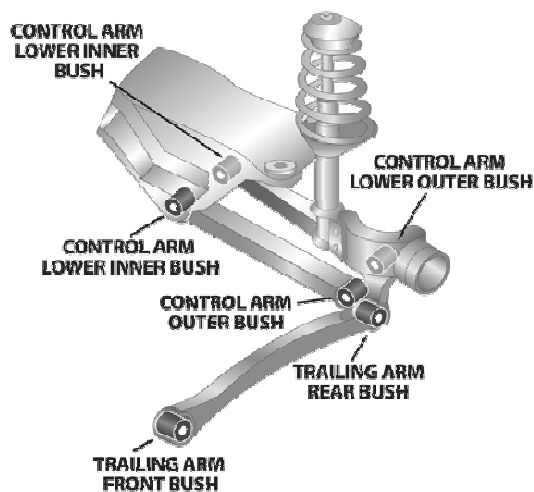
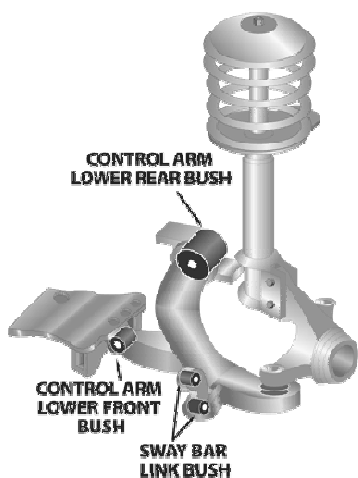

Aplicaci...	Descripción	Referencia	Kits por...	Contenido del Kit	
DEL.	Control Arm Lower Rear Bushing 1600cc PS & DS increased caster "Peg style mount"	<b>MPU-1142AK</b>	1	Bushings	
DEL.	Control Arm Lower Rear Bushing 1800cc PS & DS standard "Bolt on style mount"	<b>MPU-0837K</b>	1	Inner Tubes, Bushings	
DEL.	Control Arm Lower Rear Bushing 1800cc PS inc DS standard caster "Bolt on style mount"	<b>MPU-0838K</b>	1	Inner Tubes, Bushings	
DEL.	Control Arm Lower Rear Bushing 1800cc PS & DS inc caster "Bolt on style mount"	<b>MPU-0839AK</b>	1	Bushings, Inner Tubes	
DEL.	Control Arm Lower Rear Bushing 1800cc PS inc DS decrease caster "Bolt on style mount"	<b>MPU-0839K</b>	1	Bushings, Inner Tubes	
DEL.	Control Arm Lower Rear Bushing 1600cc PS & DS standard "Peg style mount"	<b>MPU-1140K</b>	1	Bushings	
DEL.	Control Arm Lower Rear Bushing 1600cc PS inc DS standard caster "Peg style mount"	<b>MPU-1141K</b>	1	Bushings	



## HYUNDAI Lantra J1 GL Sedan - 5/1991 - 8/1995

Página 2 (Continúa)







Aplicaci...	Descripción	Referencia	Kits por...	Contenido del Kit	
DEL.	Control Arm Lower Rear Bushing 1600cc PS inc DS decrease caster "Peg style mount"	<b>MPU-1142K</b>	1	Bushings	
DEL.	Control Arm Lower-Inner Front Kit	<b>MPU-1870K</b>	1	Bushings, Inner Tubes	
DEL.	Sway Bar Link Bushing Kit	<b>MPU-0903K</b>	1	Bushings	
DEL.	Sway Bar Mount To Chassis Bushing Measure bar diameter 20mm available	<b>MPU-1875-__K</b>	1	Bushings	
F & R	Complete Sports Performance Kit 1600cc engine "No sway bar bushes included in kit"	<b>MPK-079-1600K</b>	1		
F & R	Complete Sports Performance Kit 1800cc engine "No sway bar bushes included in kit"	<b>MPK-079-1800K</b>	1		

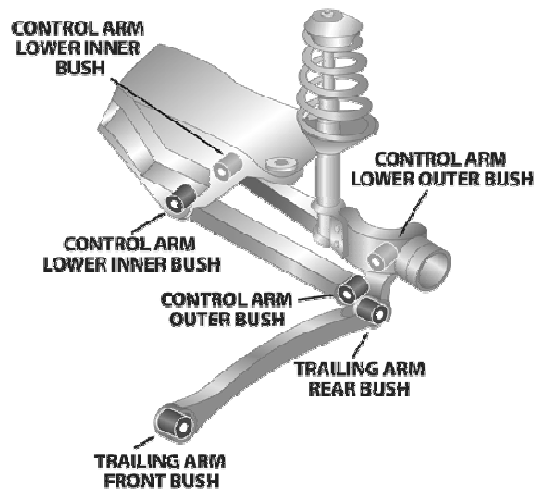
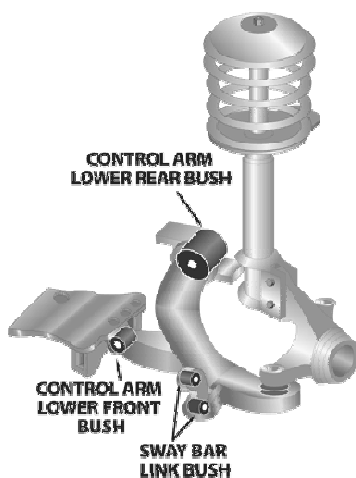

**HYUNDAI Lantra J1 GL Sedan - 5/1991 - 8/1995**

Página 3 (Continúa)









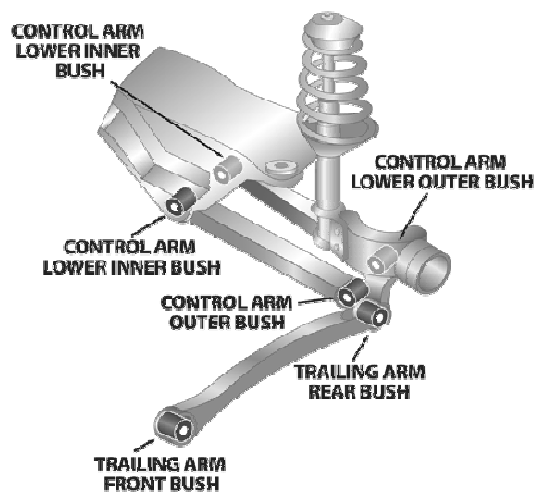
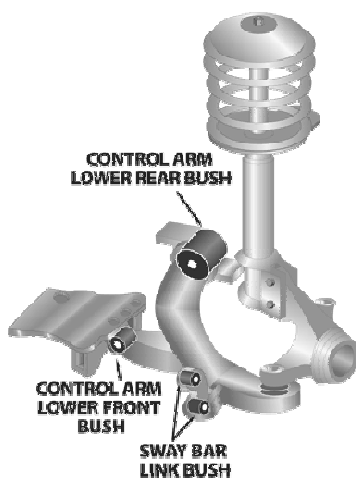

Aplicaci...	Descripción	Referencia	Kits por...	Contenido del Kit	
TRAS.	Panhard Rod Bushing	<b>MPU-1874K</b>	1	Bushings, Inner Tubes	
TRAS.	Trailing Arm - Front Bushing	<b>MPU-1873K</b>	1	Bushings, Inner Tubes	

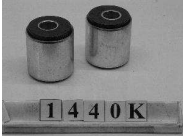

## HYUNDAI Lantra J2 Sedan & Sportswagon - 5/1995 - 1999

Página 1







Aplicaci...	Descripción	Referencia	Kits por...	Contenido del Kit	
DEL.	Control Arm Lower Rear Bushing PS & DS standard	<b>MPU-1440K</b>	1	Bushings, Inner Tubes, Outer Shells	
DEL.	Control Arm Lower Rear Bushing PS increased DS standard caster	<b>MPU-1441K</b>	1	Bushings, Inner Tubes, Outer Shells	
DEL.	Control Arm Lower Rear Bushing PS increased DS increase / decrease caster	<b>MPU-1442K</b>	1	Bushings, Inner Tubes, Outer Shells	
DEL.	Control Arm Lower-Inner Front Kit	<b>MPU-1870K</b>	1	Bushings, Inner Tubes	
DEL.	Sway Bar Mount To Chassis Bushing Measure bar diameter 24,25mm available	<b>MPU-1872-__K</b>	1	Bushings	
F & R	Complete Sports Performance Kit No sway bar bushes included in kit	<b>MPK-080K</b>	1		
TRAS.	Control Arm-Front Inner & Outer Kit	<b>MPU-0825K</b>	1	Inner Tubes, Bushings	

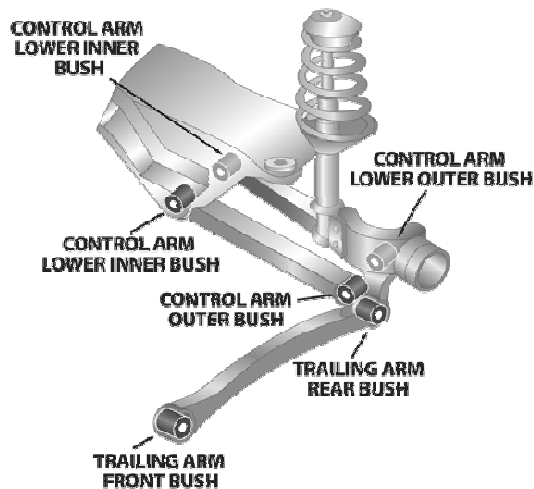
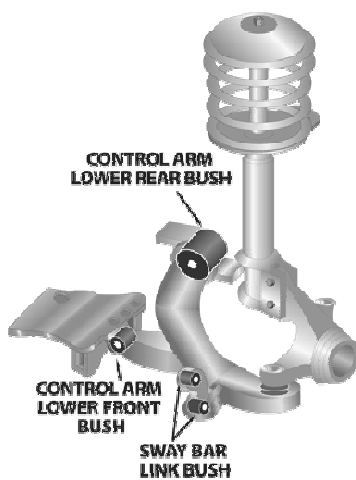

## HYUNDAI Lantra J2 Sedan & Sportswagon - 5/1995 - 1999

Página 2 (Continúa)



Aplicaci...	Descripción	Referencia	Kits por...	Contenido del Kit	
TRAS.	Control Arm-Rear Inner & Outer Kit	<b>MPU-0825K</b>	1	Inner Tubes, Bushings	 0 8 2 5 K
TRAS.	Sway Bar Mount To Chassis Bushing Measure bar diameter 14,17mm available	<b>MPU-1871-__K</b>	1	Bushings	
TRAS.	Trailing Arm - Bushing Kit	<b>MPU-0823K</b>	1	Inner Tubes, Bushings	 SPF0823K

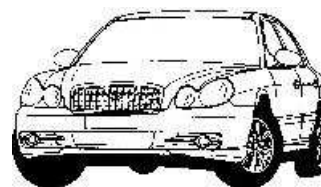

HYUNDAI Sonata EF-B Sedan, Vin # KMHEM - 9/2000 - 2003

Página 1

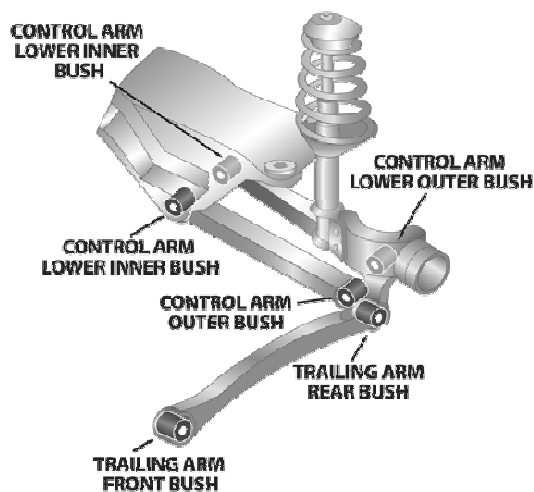
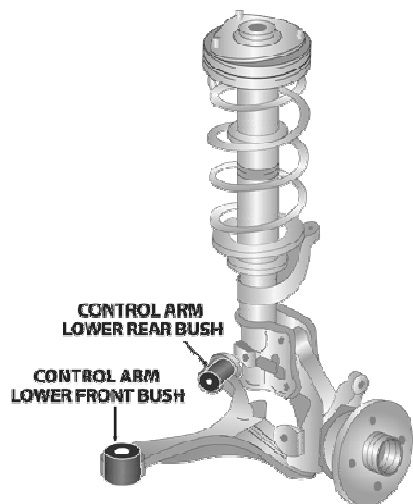







Aplicaci...	Descripción	Referencia	Kits por...	Contenido del Kit	
DEL.	Control Arm Lower-Inner Rear Eccentric Single Offset; PS increase / DS standard caster.	<b>MPU-2101K</b>	1	Outer Shells, Inner Tubes, Bushings	
DEL.	Control Arm Lower-Inner Rear Eccentric Double Offset; PS & DS increase or decrease caster.	<b>MPU-2102K</b>	1	Outer Shells, Inner Tubes, Bushings	
DEL.	Control Arm Lower-Inner Rear Kit Standard Settings.	<b>MPU-2100K</b>	1	Outer Shells, Inner Tubes, Bushings	
DEL.	Sway Bar Mount To Chassis Bushing Measure bar diameter 25,27mm available, Rep OE# 5481339100	<b>MPU-2328-__K</b>	1	Bushings	
DEL.	Sway Bar To Lower Control Arm Kit End link	<b>MPU-2092BK</b>	1	Bushings	
TRAS.	Sway Bar Mount To Chassis Bushing Measure bar diameter 11,16mm available, Rep OE# 5557738600	<b>MPU-2329-__K</b>	1	Bushings	



## ISUZU D-Max First & Second Generation - 2003 - 2012

Página 1









Aplicaci...	Descripción	Referencia	Kits por...	Contenido del Kit	
DEL.	Control Arm Upper-Inner Kit	<b>MPU-2014K</b>	1	Outer Shells, Inner Tubes, Bushings	 SPF2014K
DEL.	Steering Rack & Pinion Mount Bushing	<b>MPU-2484K</b>	1	Inner Tubes, Bushings	
DEL.	Sway Bar Mount To Chassis Bushing Measure bar diameter 18,19,20,24,25.5,27mm available.	<b>MPU-0971-__K</b>	1	Bushings	
TRAS.	Leaf Spring Bushing All SPF0972K x 1,SPF2231-8K x 1.	<b>MPK-070K</b>	1		
TRAS.	Spring Front Eye Bushing	<b>MPU-0972K</b>	1	Inner Tubes, Bushings	 SPF0972K
TRAS.	Spring Rear Bushing All	<b>MPU-2231-8K</b>	1	Bushings	 SPF2231-8K

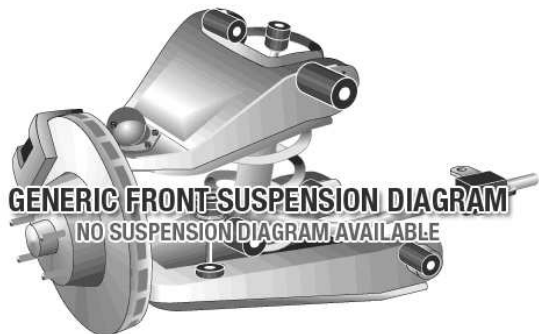

**ISUZU D-Max RG - 2012 - On**

Página 1



Aplicaci...	Descripción	Referencia	Kits por...	Contenido del Kit	
DEL.	Shock Absorber Bushing	<b>MPU-2833K</b>	1	Bushings	 SPF2833K
TRAS.	Spring Front Eye Bushing	<b>MPU-2670K</b>	1	Inner Tubes, Bushings	
TRAS.	Spring Rear Bushing All This kit contains - SPF2231-4K x 1, SPF4040K x 1, SPF2670K x 1	<b>MPK-185K</b>	1	Inner Tubes, Bushings	
TRAS.	Spring Rear Lower Bushing	<b>MPU-2231-4K</b>	1	Bushings	 SPF2231-4K
TRAS.	Spring Rear Upper Shackle Bushing	<b>MPU-4040K</b>	1	Bushings	 SPF4040K









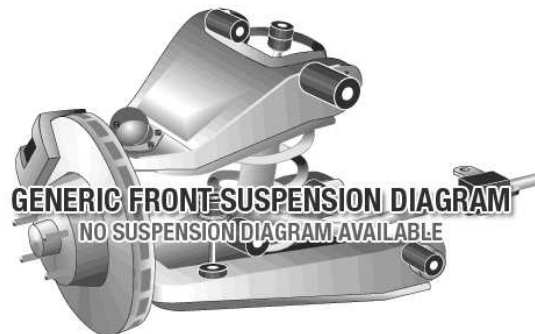
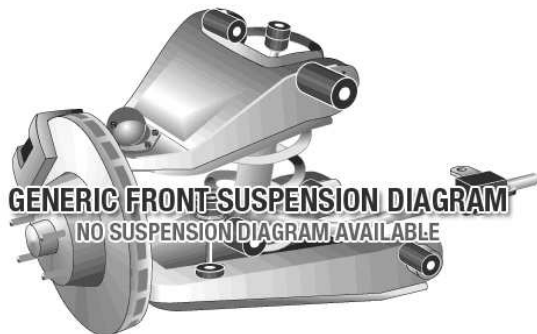



## JEEP Grand Cherokee WJ & WG Laredo, Limited - 1999 - 2005

Página 1









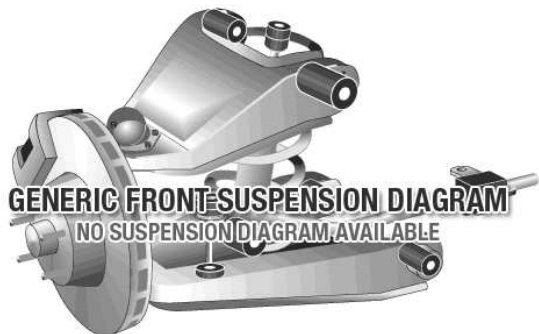

Aplicaci...	Descripción	Referencia	Kits por...	Contenido del Kit	
DEL.	Trailing Arm Upper Bushing All Re-use original factory outer shell	<b>MPU-2842K</b>	1	Inner Tubes, Bushings	
DEL.	Panhard Rod Bushing	<b>MPU-2832K</b>	1	Bushings, Outer Shells, Inner Tubes	
DEL.	Sway Bar Link Bushing Kit	<b>MPU-2829K</b>	1	Inner Tubes, Bushings	
DEL.	Sway Bar Mount Bushing Measure bar diameter, 30 & 32mm available.	<b>MPU-2824-__K</b>	1	Bushings	
DEL.	Trailing Arm Lower Front Bushing Differential end of arm, Oval type bushing, re-use original shell	<b>MPU-2826K</b>	1	Inner Tubes, Bushings	
DEL.	Trailing Arm Lower Rear Bushing Chassis end. Kit includes replacement outer shells, 73mm long crush tube.	<b>MPU-2839K</b>	1	Outer Shells, Inner Tubes, Bushings	
DEL.	Trailing Arm Lower Rear Bushing Chassis end, re-use original factory outer shell.	<b>MPU-2841K</b>	1	Inner Tubes, Bushings	



## JEEP Grand Cherokee WJ & WG Laredo, Limited - 1999 - 2005

Página 2 (Continúa)









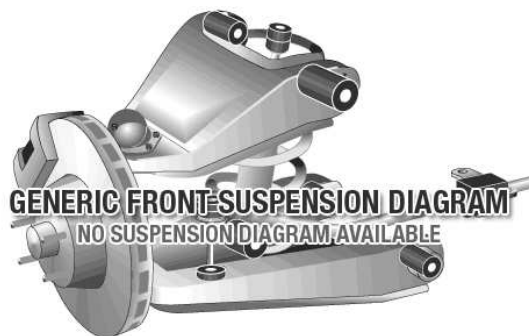
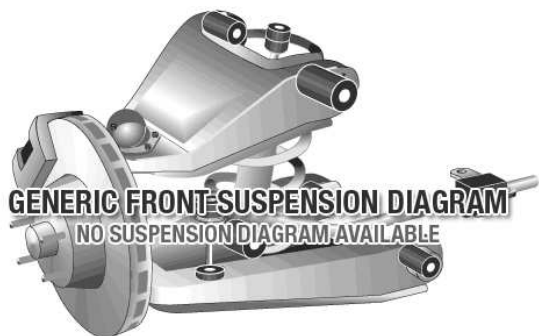

Aplicaci...	Descripción	Referencia	Kits por...	Contenido del Kit	
DEL.	Trailing Arm Upper Bushing All New outer shells supplied in kit	<b>MPU-1263K</b>	1	Outer Shells, Inner Tubes, Bushings	 SPF1263K
TRAS.	Control Arm Upper-Rear Bushing STANDARD REPLACEMENT KIT	<b>MPU-3669K</b>	1	Bushings, Outer Shells, Inner Tubes, Washers	 SPF3669K
TRAS.	Sway Bar Link Bushing Kit	<b>MPU-2831K</b>	1	Bushings, Inner Tubes, Washers	
TRAS.	Sway Bar Mount To Axle Bushing Measure bar diameter 14,15,16,21,22,24,26,30mm now available	<b>MPU-1138-__K</b>	1	Bushings	 SPF1138-__K
TRAS.	Trailing Arm Lower Front Bushing Chassis end. Kit includes replacement outer shells, 73mm long crush tube.	<b>MPU-2839K</b>	1	Outer Shells, Inner Tubes, Bushings	 SPF2839K
TRAS.	Trailing Arm Lower Front Bushing Chassis end, re-use original factory outer shell.	<b>MPU-2841K</b>	1	Inner Tubes, Bushings	 SPF2841K
TRAS.	Trailing Arm Lower Rear Bushing Differential end of arm, Oval type bushing, re-use original shell	<b>MPU-2826K</b>	1	Inner Tubes, Bushings	 SPF2826K



JEEP Grand Cherokee ZG Laredo, Limited - 4/1996 - 5/1999

Página 1









Aplicaci...	Descripción	Referencia	Kits por...	Contenido del Kit	
DEL.	Sway Bar Mount To Axle Bushing Measure bar diameter 14,15,16,21,22,24,26,30mm now available	MPU-1138-__K	1	Bushings	 SPF1138- K
DEL.	Trailing Arm Lower Bushing All Where tube is 66.5mm long, New outer shells supplied in this kit.	MPU-1264K	1	Outer Shells, Inner Tubes, Bushings	 SPF1264K
DEL.	Trailing Arm Lower Bushing All Must re-use original outer shell, Original inner tube is 66.5 long.	MPU-2856K	1	Inner Tubes, Bushings	
DEL.	Trailing Arm Upper Bushing All New outer shells supplied in kit	MPU-1263K	1	Outer Shells, Inner Tubes, Bushings	 SPF1263K
DEL.	Trailing Arm Upper Bushing All Re-use original factory outer shell	MPU-2842K	1	Inner Tubes, Bushings	 SPF2842K
TRAS.	Sway Bar Link Bushing Kit	MPU-2755SK	1	Bushings	 SPF2755SK
TRAS.	Sway Bar Mount To Axle Bushing Measure bar diameter 14,15,16,21,22,24,26,30mm now available	MPU-1138-__K	1	Bushings	 SPF1138- K

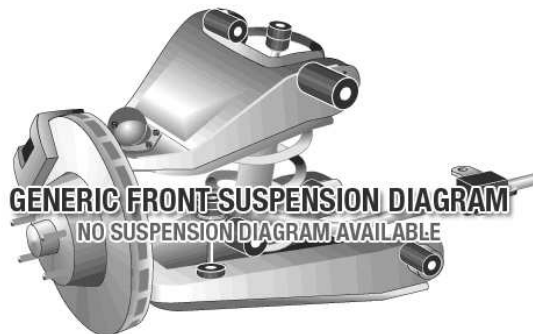
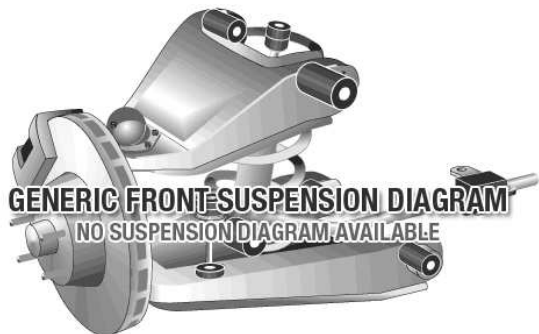

**JEEP Grand Cherokee ZG Laredo, Limited - 4/1996 - 5/1999**

Página 2 (Continúa)



Aplicaci...	Descripción	Referencia	Kits por...	Contenido del Kit	
TRAS.	Trailing Arm Lower Bushing All Where tube is 66.5mm long, New outer shells supplied in this kit.	<b>MPU-1264K</b>	1	Outer Shells, Inner Tubes, Bushings	 SPF1264K
TRAS.	Trailing Arm Lower Bushing All Must re-use original outer shell, Original inner tube is 66.5 long.	<b>MPU-2856K</b>	1	Inner Tubes, Bushings	
TRAS.	Trailing Arm Upper Bushing All New outer shells supplied in kit	<b>MPU-1263K</b>	1	Outer Shells, Inner Tubes, Bushings	 SPF1263K
TRAS.	Trailing Arm Upper Bushing All Re-use original factory outer shell	<b>MPU-2842K</b>	1	Inner Tubes, Bushings	 SPF2842K



## JEEP Wrangler JK 2 & 4 Door - 2008 - Current

Página 1

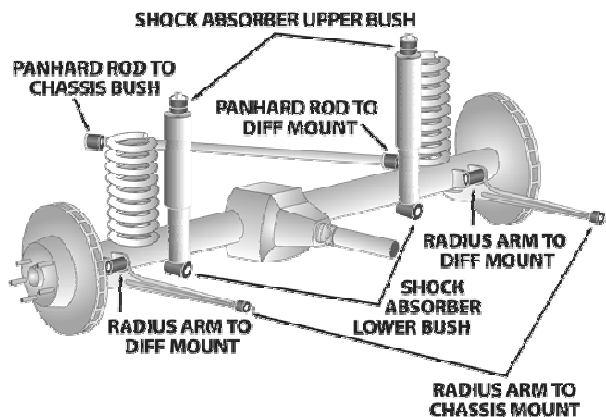
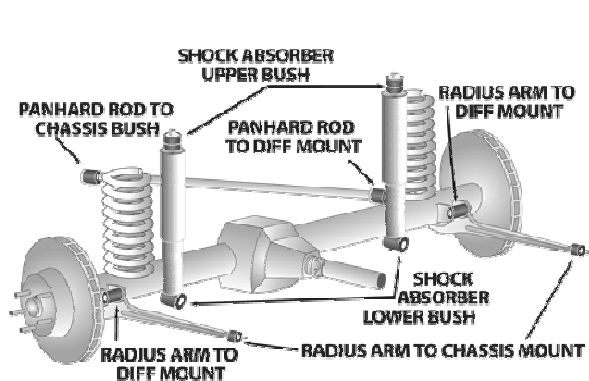

Aplicaci...	Descripción	Referencia	Kits por...	Contenido del Kit	
DEL.	Coil Spring Spacer Bushing Re-use original spacer	<b>MPU-1735-15K</b>	2	Bushings	
DEL.	Coil Spring Spacer Bushing Re-use original spacer	<b>MPU-1735-30K</b>	2	Bushings	
DEL.	Panhard Rod Bushing	<b>MPU-3656K</b>	1	Outer Shells, Inner Tubes, Bushings	
DEL.	Panhard Rod Bushing Measure Shell Diameter.	<b>MPU-3912K</b>	1	Outer Shells, Inner Tubes, Bushings	
DEL.	Shock Absorber Lower Bushing Factory Shock Absorber	<b>MPU-3220K</b>	1	Inner Tubes, Bushings	
DEL.	Shock Absorber Upper Bushing Factory Shock Absorber	<b>MPU-3219K</b>	1	Bushings	
DEL.	Sway Bar Link Lower Bushing	<b>MPU-3659K</b>	1	Inner Tubes, Bushings	



## JEEP Wrangler JK 2 & 4 Door - 2008 - Current

Página 2 (Continúa)

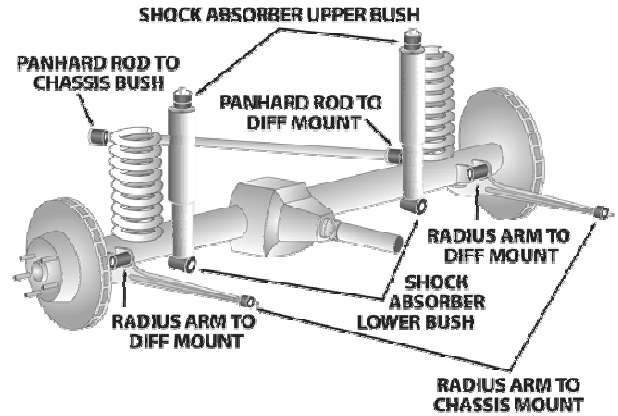
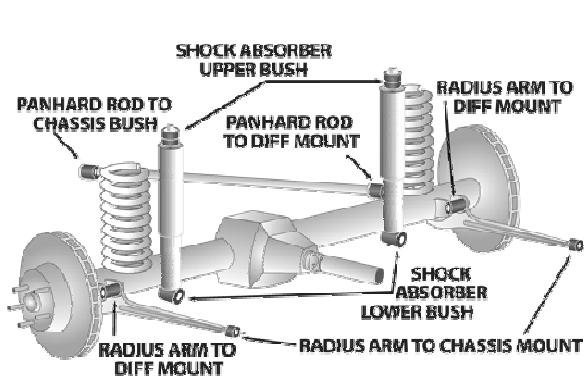

Aplicaci...	Descripción	Referencia	Kits por...	Contenido del Kit	
DEL.	Sway Bar Mount To Chassis Bushing Measure bar diameter 30mm available	MPU-2030-__K	1	Bushings	
DEL.	Trailing Arm Lower Bushing All	MPU-3655K	1	Inner Tubes, Bushings	
DEL.	Trailing Arm Upper Front Bushing	MPU-3751K	1	Outer Shells, Inner Tubes, Bushings	
DEL.	Trailing Arm Upper Rear Bushing	MPU-3654K	1	Inner Tubes, Bushings	
F & R	SuperPro Enhancement Kit THIS KIT CONTAINS - SPF3656K x 1,SPF3655K x 1,SPF3751K x 1,SPF3654K x 1,SPF3658K x 1,SPF3661K x...	MPK-173K	1	Outer Shells, Inner Tubes, Bushings	
TRAS.	Sway Bar Mount To Chassis Bushing Measure Bar Diameter	MPU-1138-__K	1	Bushings	
TRAS.	Panhard Rod Bushing	MPU-3658K	1	Outer Shells, Inner Tubes, Bushings	



## JEEP Wrangler JK 2 & 4 Door - 2008 - Current

Página 3 (Continúa)

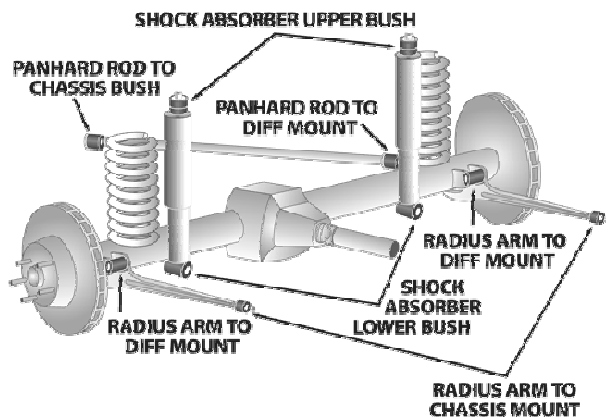
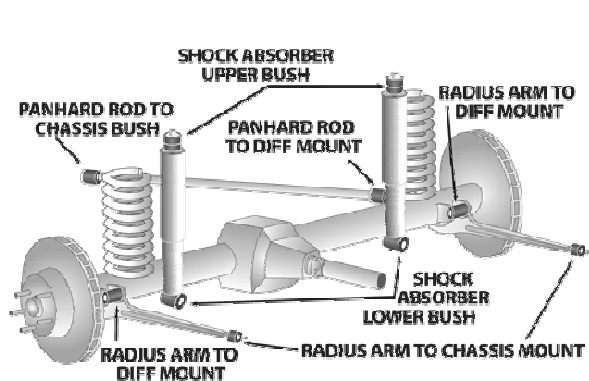







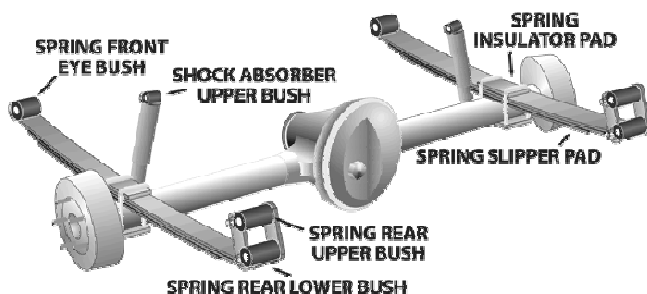
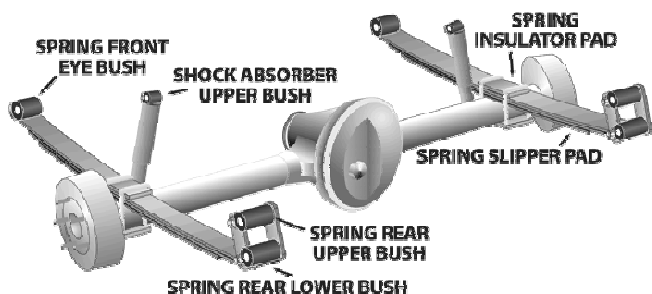

Aplicaci...	Descripción	Referencia	Kits por...	Contenido del Kit	
TRAS.	Sway Bar Link Lower Bushing	<b>MPU-3659K</b>	1	Inner Tubes, Bushings	 SPF3659K
TRAS.	Trailing Arm Lower Bushing All	<b>MPU-3661K</b>	1	Inner Tubes, Bushings	 SPF3661K
TRAS.	Trailing Arm Upper Bushing All	<b>MPU-3660K</b>	1	Inner Tubes, Bushings	 SPF3660K



**JEEP CJ 7 & CJ 8 CJ7 & CJ8 - 1973 - 1985**

Página 1



Aplicaci...	Descripción	Referencia	Kits por...	Contenido del Kit	
DEL.	Leaf Spring Bushing All	<b>MPU-0107K</b>	1	Bushings	
DEL.	Shock Absorber Upper / Lower Bushing	<b>MPU-2178-16K</b>	2	Bushings	
DEL.	Spring Rear Eye Bushing	<b>MPU-0109K</b>	1	Bushings, Inner Tubes	
F & R	Complete Kit	<b>MPK-089K</b>	1	Inner Tubes, Bushings	
TRAS.	Shock Absorber Upper / Lower Bushing	<b>MPU-2178-16K</b>	2	Bushings	
TRAS.	Spring Front Eye Bushing	<b>MPU-0108K</b>	1	Bushings, Inner Tubes	
TRAS.	Spring Rear Bushing All	<b>MPU-0106K</b>	1	Bushings	









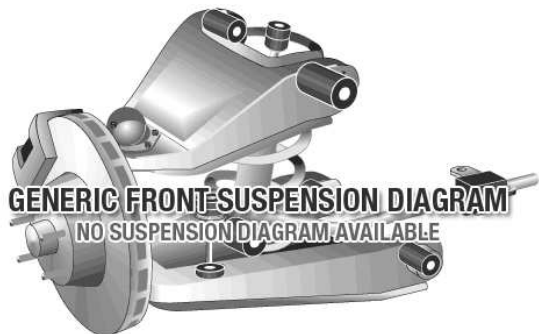



## JEEP Cherokee XJ Limited & Sport Wagon - 4/1994 - 9/2001

Página 1









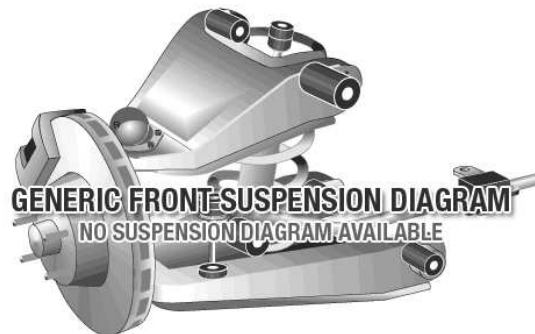
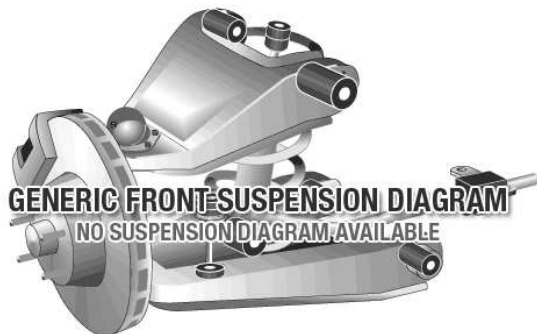

Aplicaci...	Descripción	Referencia	Kits por...	Contenido del Kit	
DEL.	Trailing Arm Upper Bushing All New outer shells supplied in kit	<b>MPU-1263K</b>	1	Outer Shells, Inner Tubes, Bushings	 SPF1263K
DEL.	Coil Spring Spacer Bushing Re-use original spacer	<b>MPU-1735-15K</b>	2	Bushings	 SPF1735-15K
DEL.	Coil Spring Spacer Bushing Re-use original spacer	<b>MPU-1735-30K</b>	2	Bushings	 SPF1735-30K
DEL.	Panhard Rod To Diff Mount Bushing	<b>MPU-1081K</b>	1	Bushings, Inner Tubes	 1 0 8 1 K
DEL.	Shock Absorber Upper Bushing	<b>MPU-2755SK</b>	1	Bushings	 SPF2755SK
DEL.	Sway Bar Link Lower Bushing	<b>MPU-1139K</b>	1	Bushings, Inner Tubes	 1 1 3 9 K
DEL.	Sway Bar Link Upper Bushing Use when vehicle has no location washers	<b>MPU-1150K</b>	1	Bushings	 1 1 5 0 K



## JEEP Cherokee XJ Limited & Sport Wagon - 4/1994 - 9/2001

Página 2 (Continúa)









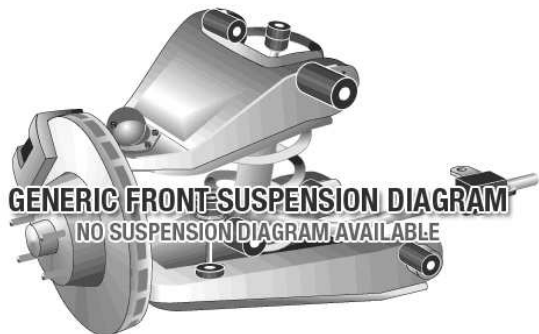

Aplicaci...	Descripción	Referencia	Kits por...	Contenido del Kit	
DEL.	Sway Bar Link Upper Bushing Use when vehicle / shocks have location washer	<b>MPU-2755SK</b>	1	Bushings	
DEL.	Sway Bar Mount Bushing Measure bar diameter 14,15,16,21,22,24,26,30mm now available	<b>MPU-1138-__K</b>	1	Bushings	
DEL.	Trailing Arm Lower Bushing All Where tube is 66.5mm long, New outer shells supplied in this kit.	<b>MPU-1264K</b>	1	Outer Shells, Inner Tubes, Bushings	
DEL.	Trailing Arm Lower Bushing All Must re-use original outer shell, Original inner tube is 66.5 long.	<b>MPU-2856K</b>	1	Inner Tubes, Bushings	
DEL.	Trailing Arm Upper Bushing All Re-use original factory outer shell	<b>MPU-2842K</b>	1	Inner Tubes, Bushings	
TRAS.	Leaf Spring Bushing All SPF0969Kx1SPF0970Kx1,SPF1080Kx1 "63mm wide"	<b>MPK-071K</b>	1		
TRAS.	Leaf Spring Bushing All SPF1737Kx1SPF1738Kx1,SPF1080Kx1 "65mm wide"	<b>MPK-084K</b>	1		



## JEEP Cherokee XJ Limited & Sport Wagon - 4/1994 - 9/2001

Página 3 (Continúa)





Aplicaci...	Descripción	Referencia	Kits por...	Contenido del Kit	
TRAS.	Shock Absorber Lower Bushing	<b>MPU-2178-16K</b>	1	Bushings	 SPF2178- K
TRAS.	Spring Front Eye Bushing 63mm wide original springs	<b>MPU-0969K</b>	1	Bushings, Inner Tubes	 0969K
TRAS.	Spring Front Eye Bushing 65mm wide after-market springs only	<b>MPU-1737K</b>	1	Bushings, Inner Tubes	 1737K
TRAS.	Spring Rear Eye Bushing 63mm wide original springs	<b>MPU-0970K</b>	1	Bushings, Inner Tubes	 0970K
TRAS.	Spring Rear Eye Bushing 65mm wide after-market springs only	<b>MPU-1738K</b>	1	Bushings, Inner Tubes	 1738K
TRAS.	Spring Shackle Upper Bushing	<b>MPU-1080K</b>	1	Inner Tubes, Bushings	 1080K
TRAS.	Sway Bar Link Lower Bushing	<b>MPU-1139K</b>	1	Bushings, Inner Tubes	 1139K

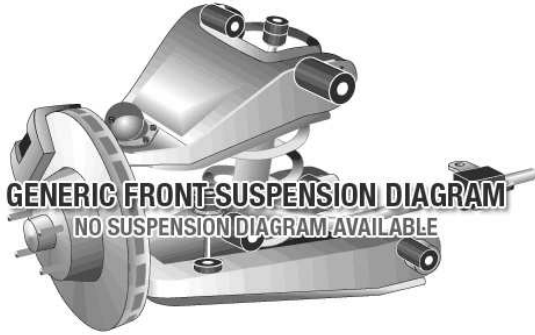

**JEEP Cherokee XJ Limited & Sport Wagon - 4/1994 - 9/2001**

Página 4 (Continúa)









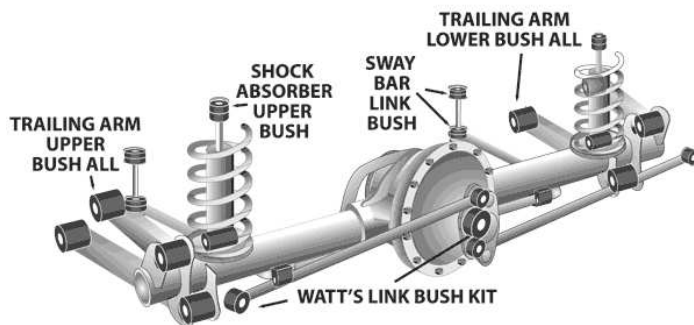
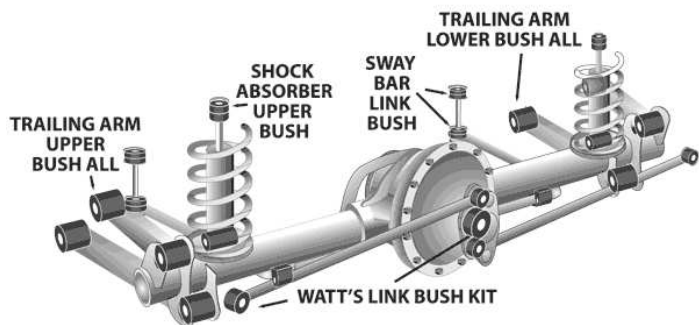

Aplicaci...	Descripción	Referencia	Kits por...	Contenido del Kit	
TRAS.	Sway Bar Mount Bushing Measure bar diameter 14,15,16,21,22,24,26,30mm now available	<b>MPU-1138-__K</b>	1	Bushings	 SPF1138- K

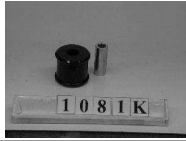

## JEEP Wrangler TJ Soft Top / Hard Top - 10/1996 - 2005

Página 1



Aplicaci...	Descripción	Referencia	Kits por...	Contenido del Kit	
DEL.	Trailing Arm Upper Bushing All New outer shells supplied in kit	<b>MPU-1263K</b>	1	Outer Shells, Inner Tubes, Bushings	 SPF1263K
DEL.	Coil Spring Spacer Bushing Re-use original spacer	<b>MPU-1735-15K</b>	2	Bushings	 SPF1735-15K
DEL.	Coil Spring Spacer Bushing Re-use original spacer	<b>MPU-1735-30K</b>	2	Bushings	 SPF1735-30K
DEL.	Panhard Rod To Diff Mount Bushing Diff end only, (Chassis end is ball joint type)	<b>MPU-1081K</b>	1	Bushings, Inner Tubes	 1081K
DEL.	Sway Bar Link Bushing Kit	<b>MPU-1723K</b>	1	Bushings, Inner Tubes	 1723K
DEL.	Sway Bar Mount To Chassis Bushing Measure bar diameter 30mm available	<b>MPU-2030-__K</b>	1	Bushings	 SPF2030- K
DEL.	Trailing Arm Lower Bushing All Where tube is 66.5mm long, New outer shells supplied in this kit.	<b>MPU-1264K</b>	1	Outer Shells, Inner Tubes, Bushings	 SPF1264K



## JEEP Wrangler TJ Soft Top / Hard Top - 10/1996 - 2005

Página 2 (Continúa)

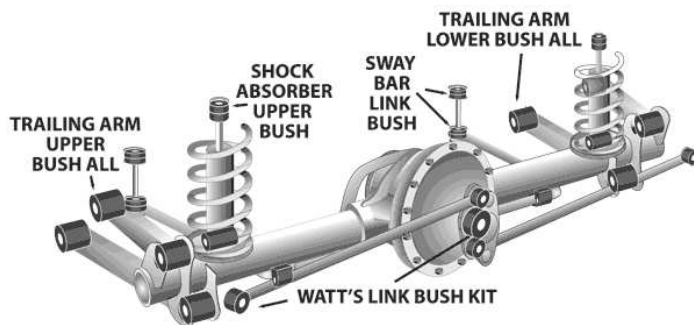
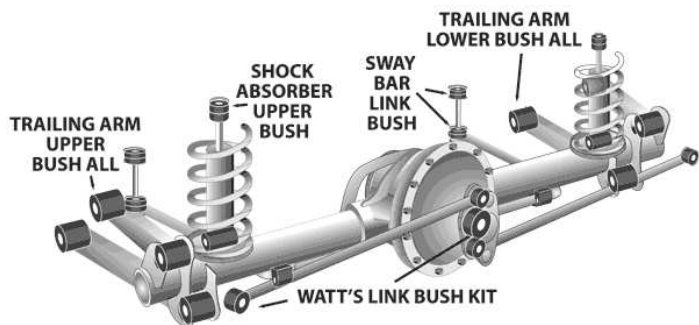







Aplicaci...	Descripción	Referencia	Kits por...	Contenido del Kit	
DEL.	Trailing Arm Lower Bushing All Must re-use original outer shell, Original inner tube is 66.5 long.	<b>MPU-2856K</b>	1	Inner Tubes, Bushings	
DEL.	Trailing Arm Upper Bushing All Re-use original factory outer shell	<b>MPU-2842K</b>	1	Inner Tubes, Bushings	
TRAS.	Coil Spring Spacer Bushing Re-use original spacer	<b>MPU-1996-10K</b>	2	Bushings	
TRAS.	Coil Spring Spacer Bushing Re-use original spacer	<b>MPU-1996-30K</b>	2	Bushings	
TRAS.	Panhard Rod Bushing Replaces OE # 2261460 "Both Ends"	<b>MPU-2343K</b>	1	Inner Tubes, Bushings	
TRAS.	Sway Bar Link Bushing Kit	<b>MPU-1225K</b>	1	Bushings, Inner Tubes, Washers	
TRAS.	Sway Bar Mount To Axle Bushing Measure bar diameter 14,15,16,21,22,24,26,30mm now available	<b>MPU-1138-__K</b>	1	Bushings	

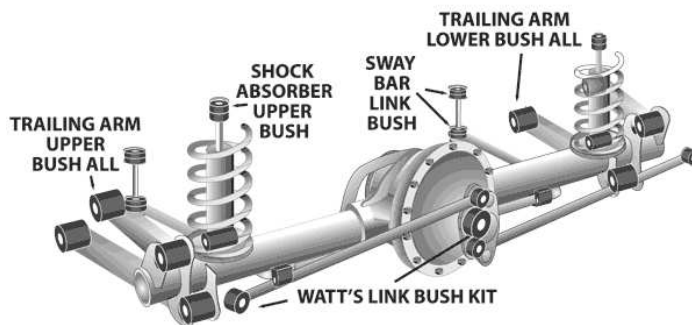
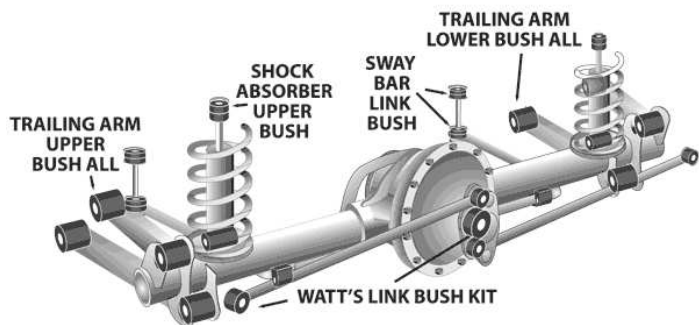

## JEEP Wrangler TJ Soft Top / Hard Top - 10/1996 - 2005

Página 3 (Continúa)





Aplicaci...	Descripción	Referencia	Kits por...	Contenido del Kit	
TRAS.	Trailing Arm Lower Bushing All Where tube is 66.5mm long, New outer shells supplied in this kit.	<b>MPU-1264K</b>	1	Outer Shells, Inner Tubes, Bushings	 SPF1264K
TRAS.	Trailing Arm Lower Bushing All Must re-use original outer shell, Original inner tube is 66.5 long.	<b>MPU-2856K</b>	1	Inner Tubes, Bushings	
TRAS.	Trailing Arm Upper Bushing All New outer shells supplied in kit	<b>MPU-1263K</b>	1	Outer Shells, Inner Tubes, Bushings	 SPF1263K
TRAS.	Trailing Arm Upper Bushing All Re-use original factory outer shell	<b>MPU-2842K</b>	1	Inner Tubes, Bushings	 SPF2842K

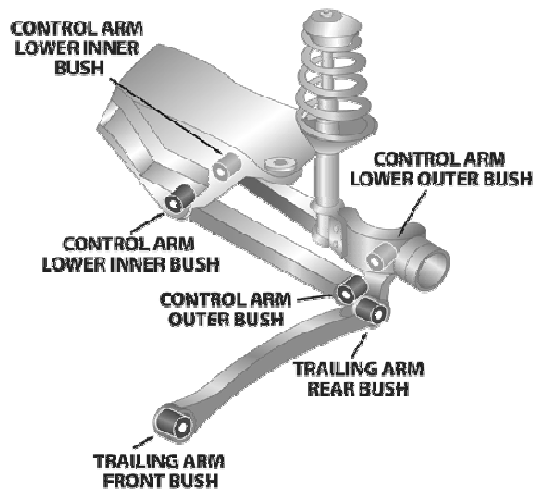
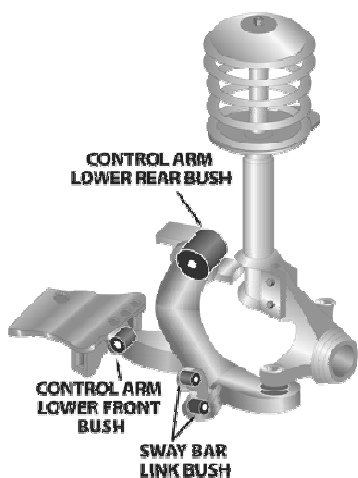

**KIA Ceres Cab Chassis & Tray Top 2WD - 1/1992 - 2000**

Página 1



Aplicaci...	Descripción	Referencia	Kits por...	Contenido del Kit	
TRAS.	Spring Rear Bushing All	MPU-0311K	2	Inner Tubes, Bushings	





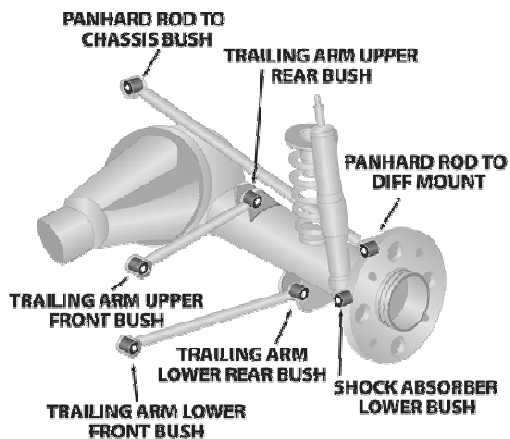
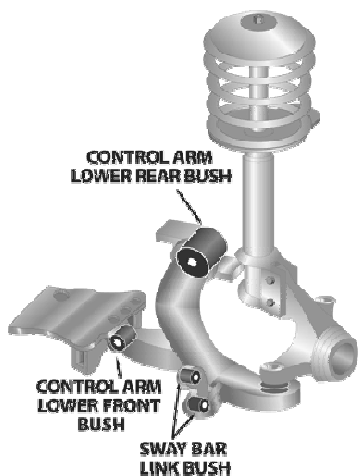

**KIA Carnival Van - 10/1999 - 2005**

Página 1





Aplicaci...	Descripción	Referencia	Kits por...	Contenido del Kit	
DEL.	Strut Bar To Chassis Mount Kit	<b>MPU-2698K</b>	1	Bushings	 SPF2698K

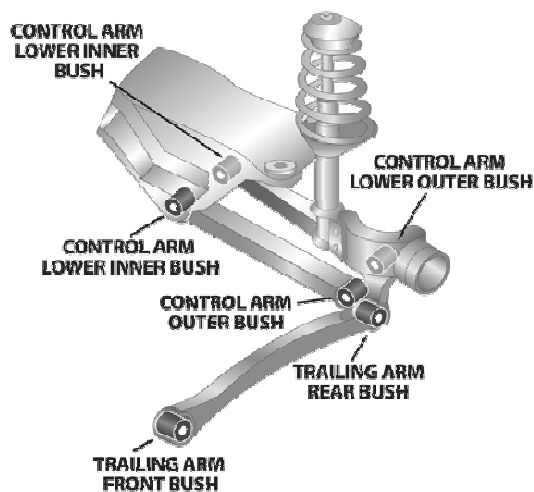
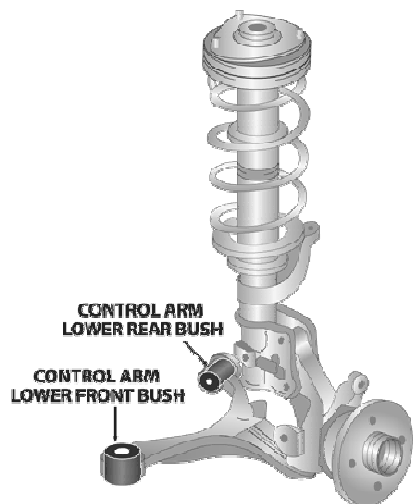

**KIA Optima / Magentis GD Sedan - 2001 - 2005**

Página 1





Aplicaci...	Descripción	Referencia	Kits por...	Contenido del Kit	
DEL.	Control Arm Lower-Inner Rear Eccentric PS increase / DS standard caster	<b>MPU-2101K</b>	1	Outer Shells, Inner Tubes, Bushings	
DEL.	Control Arm Lower-Inner Rear Eccentric PS & DS increase or decrease caster	<b>MPU-2102K</b>	1	Outer Shells, Inner Tubes, Bushings	
DEL.	Control Arm Lower-Inner Rear Kit Standard Settings	<b>MPU-2100K</b>	1	Outer Shells, Inner Tubes, Bushings	

**KIA K2700 Light Truck TU - 10/2002 - 12/2004**

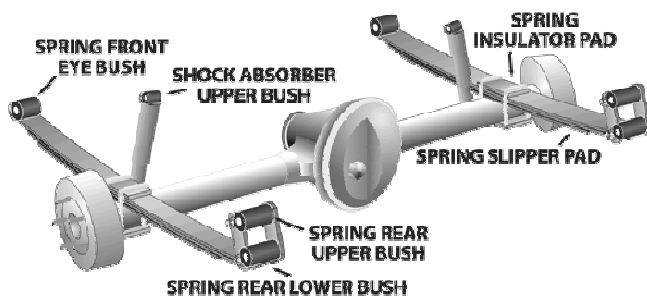
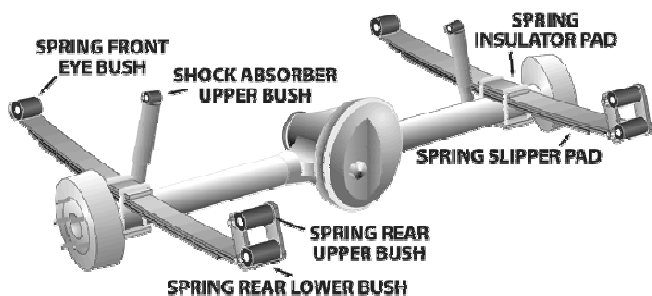
Página 1





Aplicaci...	Descripción	Referencia	Kits por...	Contenido del Kit	
DEL.	Strut Bar To Chassis Mount Kit	MPU-2698K	1	Bushings	 SPF2698K

**KIA K2700 Light Truck PU - 4/2005 - 3/2008**

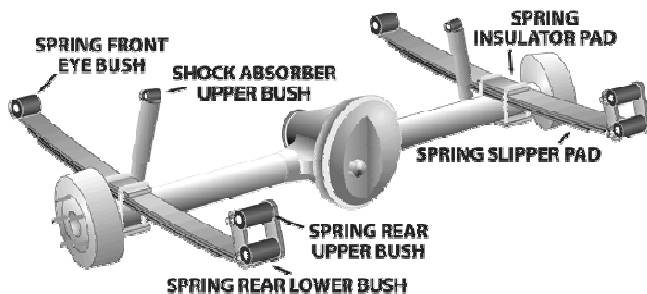
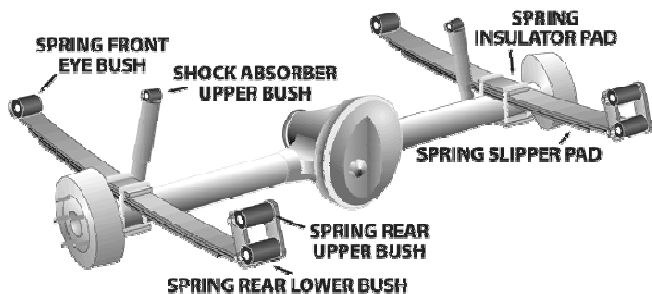
Página 1







Aplicaci...	Descripción	Referencia	Kits por...	Contenido del Kit	
DEL.	Strut Bar To Chassis Mount Kit	MPU-2698K	1	Bushings	

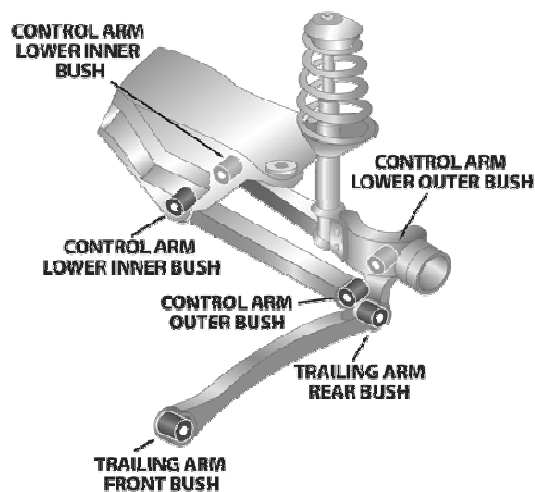
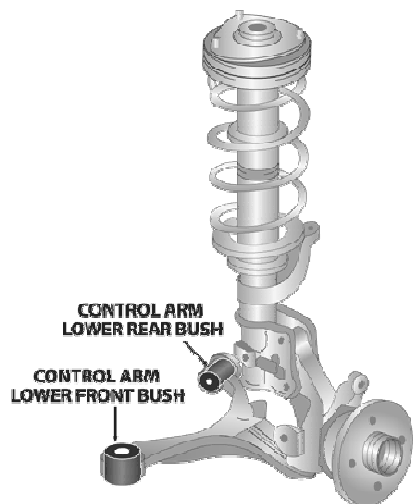

## KIA Opirus / Amanti Sedan -

Página 1







Aplicaci...	Descripción	Referencia	Kits por...	Contenido del Kit	
DEL.	Control Arm Lower-Inner Rear Kit Standard Settings.	<b>MPU-2100K</b>	1	Outer Shells, Inner Tubes, Bushings	
DEL.	Control Arm Lower-Inner Rear Eccentric PS & DS increase or decrease caster.	<b>MPU-2102K</b>	1	Outer Shells, Inner Tubes, Bushings	
DEL.	Control Arm Lower-Inner Rear Eccentric PS increase / DS standard caster.	<b>MPU-2101K</b>	1	Outer Shells, Inner Tubes, Bushings	

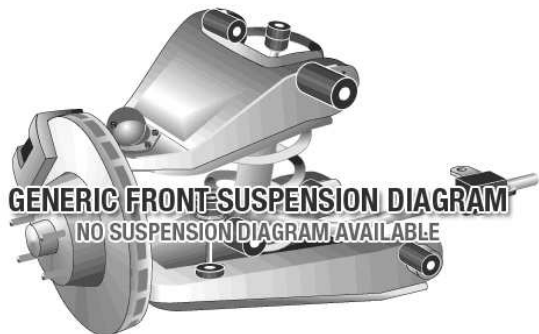

## KIA Cerato TD - 2009 - 2013

Página 1







Aplicaci...	Descripción	Referencia	Kits por...	Contenido del Kit	
DEL.	Control Arm Lower-Inner Rear Eccentric PS increase / DS standard caster.	<b>MPU-2101K</b>	1	Outer Shells, Inner Tubes, Bushings	
DEL.	Control Arm Lower-Inner Rear Eccentric PS & DS increase or decrease caster.	<b>MPU-2102K</b>	1	Outer Shells, Inner Tubes, Bushings	
DEL.	Control Arm Lower-Inner Rear Kit Standard Settings	<b>MPU-2100K</b>	1	Outer Shells, Inner Tubes, Bushings	



## KIA Cerato LD (First Generation) - 2004 - 2008

Página 1



Aplicaci...	Descripción	Referencia	Kits por...	Contenido del Kit	
DEL.	Control Arm Lower Rear Bushing Standard replacement.	<b>MPU-3133K</b>	1	Outer Shells, Inner Tubes, Bushings	
DEL.	Control Arm Lower Rear Bushing (Eccentric) 1 x Standard & 1 x offset.	<b>MPU-3134K</b>	1	Outer Shells, Inner Tubes, Bushings	
DEL.	Control Arm Lower Rear Bushing (Eccentric) 2 x Offset Bushings.	<b>MPU-3135K</b>	1	Outer Shells, Inner Tubes, Bushings	



## LAND ROVER Range Rover Wagon 4WD - 3/1987 - 8/1992

Página 1

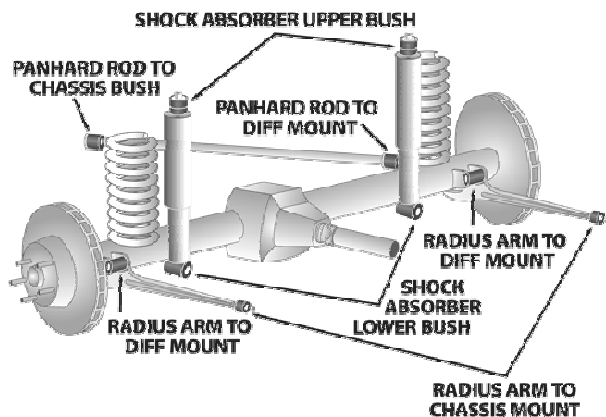
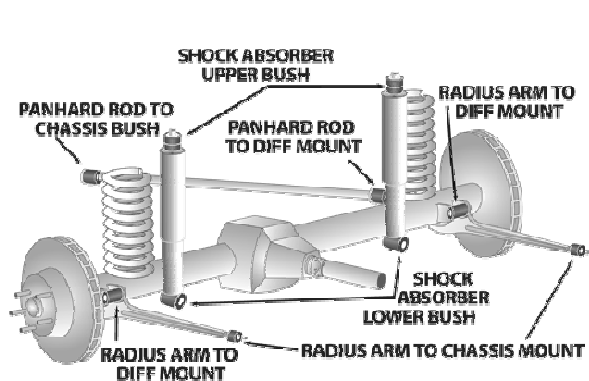

Aplicaci...	Descripción	Referencia	Kits por...	Contenido del Kit	
DEL.	Sway Bar Link Bushing Kit	<b>MPU-0078K</b>	1	Bushings	
DEL.	Panhard Rod Bushing Tube inside diameter to suit 14mm bolt	<b>MPU-0194K</b>	1	Inner Tubes, Bushings	
DEL.	Radius Arm To - Chassis, Setback Kit To correct slight pull to left (RH drive vehicle) Change of aprox 0.5 degree in setback	<b>MPU-2717K</b>	1	Bushings	
DEL.	Radius Arm To - Chassis, Setback Kit To correct strong pull to left (RH drive vehicle) Change of aprox 1.0 degree in setback	<b>MPU-2718K</b>	1	Bushings	
DEL.	Radius Arm To - Diff Mount - Eccentric Kit Caster Increase kit, 51mm Outside diameter shell, 54mm Long inner tube	<b>MPU-2509K</b>	1	Outer Shells, Inner Tubes, Bushings, Inst Sheet	
DEL.	Radius Arm To - Diff Mount Bushing Crush tube length 54mm, No Outer Shell on bushing	<b>MPU-0195K</b>	1	Inner Tubes, Bushings	
DEL.	Radius Arm To - Diff Mount Bushing Crush tube length 54mm, Kit Includes bushing with outer shell	<b>MPU-0195SK</b>	1	Outer Shells, Inner Tubes, Bushings	





## LAND ROVER Range Rover Wagon 4WD - 3/1987 - 8/1992

Página 2 (Continúa)

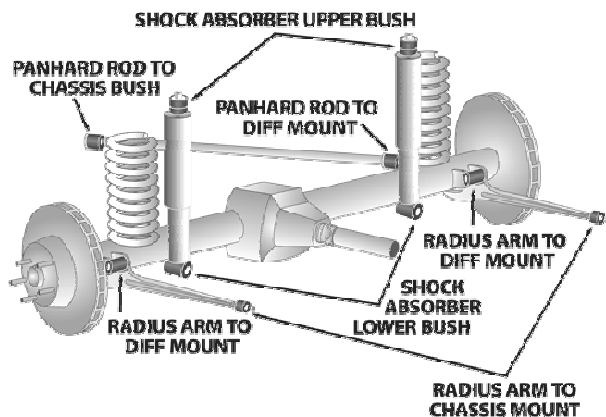
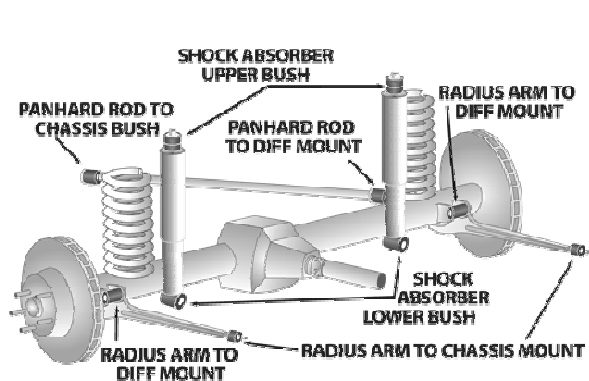







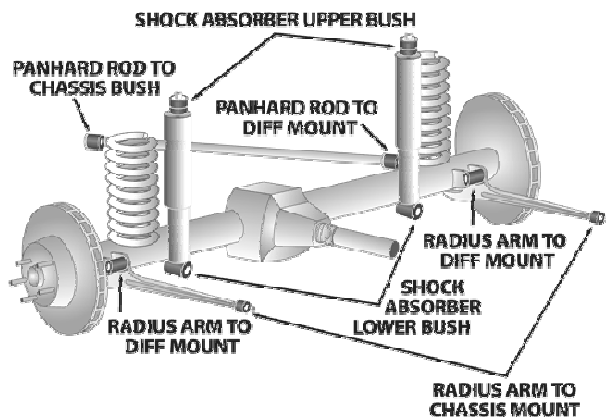
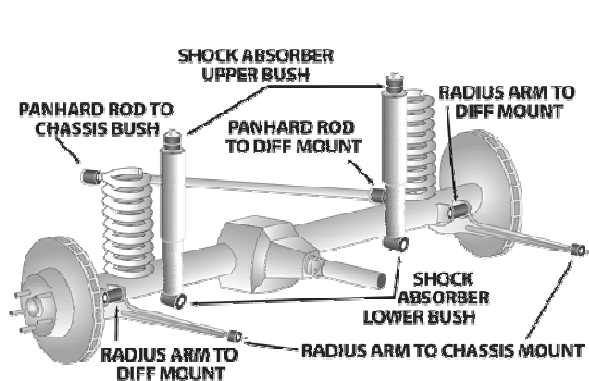

Aplicaci...	Descripción	Referencia	Kits por...	Contenido del Kit	
DEL.	Radius Arm To Chassis Mount Bushing Standard replacement kit	<b>MPU-0206K</b>	1	Bushings	
DEL.	Radius Arm To Chassis Mount Performance Use Performance use only	<b>MPU-3632K</b>	1	Inst Sheet, Washers, Bushings	
DEL.	Shock Absorber Upper / Lower Bushing Original shock absorber	<b>MPU-0075K</b>	1	Bushings	
DEL.	Shock Absorber Upper / Lower Bushing After-market shock absorbers	<b>MPU-1879K</b>	1	Bushings	
DEL.	Sway Bar Mount Bushing 30mm bracket width, Measure bar diameter 19,20,22,24,25,27,28,30,38mm	<b>MPU-0666-__K</b>	1	Bushings	
F & R	Body Mount Kit Re-use original hardware, 2 x bushes per kit, Nominate kit quantity requirement	<b>MPU-1788K</b>	0	Bushings	
F & R	Radius Arms & Panhard Rods Bush Kit Kit Includes 1xSPF0194K, 1xSPF0206K, 1xSPF2509K, 1xSPF0323K, 1xSPF0129K,...	<b>MPK-043AADJK</b>	1		



## LAND ROVER Range Rover Wagon 4WD - 3/1987 - 8/1992

Página 3 (Continúa)









Aplicaci...	Descripción	Referencia	Kits por...	Contenido del Kit	
F & R	Arm To Diff Mount Bushings	<b>MPK-043AADJK</b>	1		
F & R	Radius Arms & Panhard Rods Bush Kit Kit Includes 1xSPF0194K, 1xSPF0206K, 1xSPF0195K, 1xSPF0323K, 1xSPF0129K,...	<b>MPK-043AK</b>	1		
TRAS.	Radius Arm To - Diff Mount Bushing	<b>MPU-0129K</b>	1	Inner Tubes, Bushings	
TRAS.	Radius Arm To Chassis Mount Bushing	<b>MPU-0323K</b>	1	Plates, Washers, Inner Tubes, Bushings	
TRAS.	Shock Absorber Lower Bushing Original shock absorber	<b>MPU-0075K</b>	1	Bushings	
TRAS.	Shock Absorber Lower Bushing After-market shock absorbers	<b>MPU-1879K</b>	1	Bushings	
TRAS.	Shock Absorber Upper Bushing	<b>MPU-0779K</b>	1	Inner Tubes, Bushings	

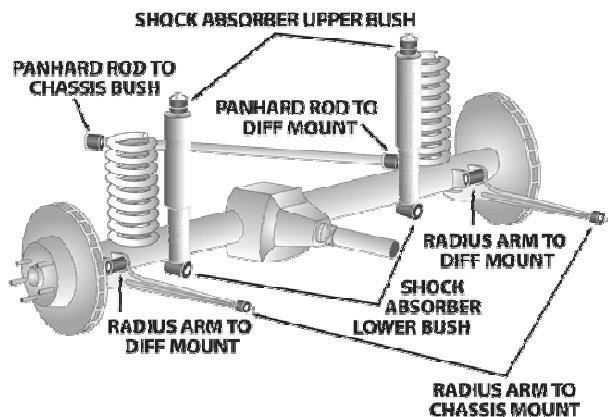
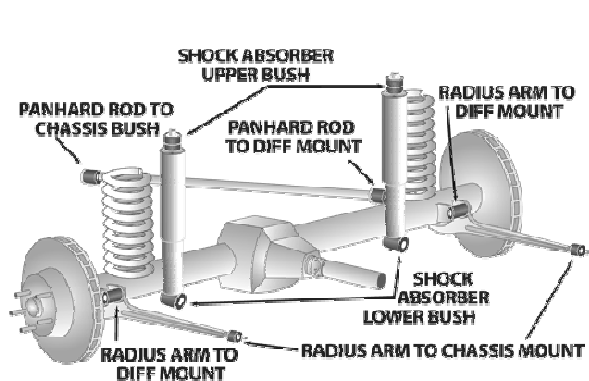

**LAND ROVER Range Rover Wagon 4WD - 3/1987 - 8/1992**

Página 4 (Continúa)









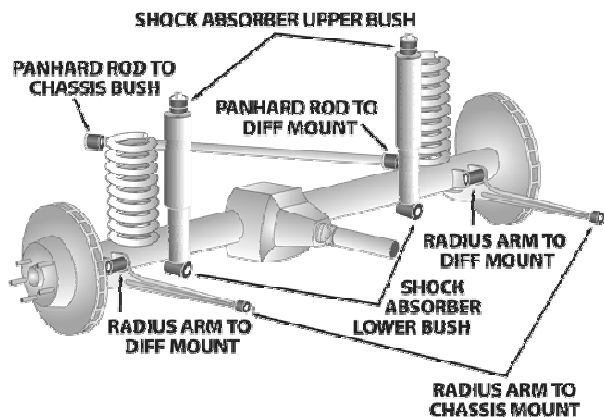
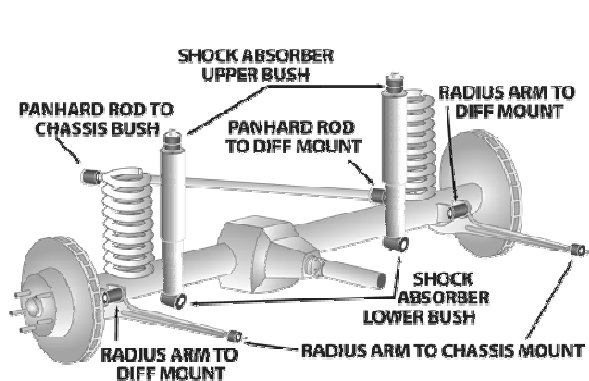

Aplicaci...	Descripción	Referencia	Kits por...	Contenido del Kit	
TRAS.	Shock Absorber Upper Bushing Aftermarket shock absorbers	<b>MPU-0078K</b>	1	Bushings	 SPF0078K
TRAS.	Sway Bar Link Bushing Kit	<b>MPU-0078K</b>	1	Bushings	 SPF0078K
TRAS.	Sway Bar Mount Bushing 30mm bracket width, Measure bar diameter 19,20,22,24,25,27,28,30,38mm	<b>MPU-0666-__K</b>	1	Bushings	
TRAS.	Trailing Arm Upper Bushing All Upper A arm to chassis bush	<b>MPU-0128K</b>	1	Inner Tubes, Bushings	 0128K



## LAND ROVER Range Rover Wagon 4WD ( Air Suspension ) -...

Página 1









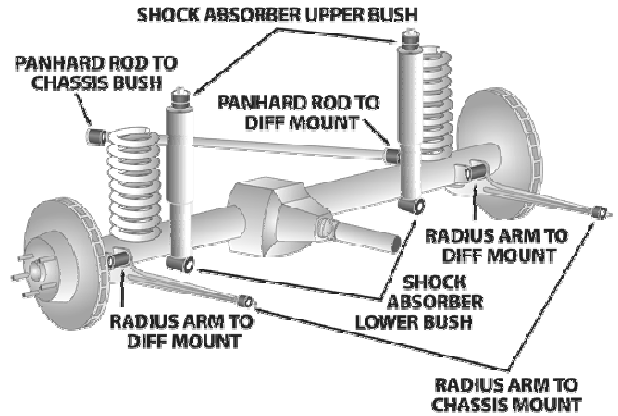
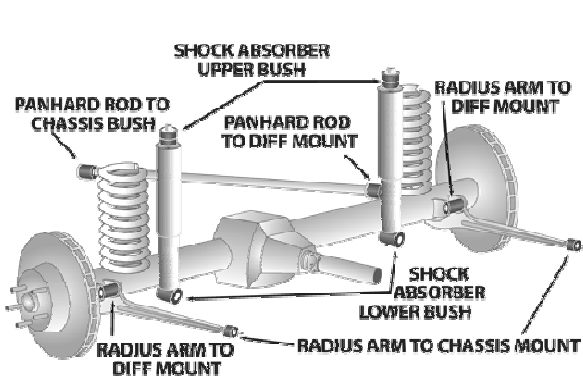

Aplicaci...	Descripción	Referencia	Kits por...	Contenido del Kit	
DEL.	Panhard Rod Bushing Tube inside diameter to suit 14mm bolt	<b>MPU-0194K</b>	1	Inner Tubes, Bushings	
DEL.	Radius Arm To - Chassis, Setback Kit To correct slight pull to left (RH drive vehicle) Change of aprox 0.5 degree in setback	<b>MPU-2717K</b>	1	Bushings	
DEL.	Radius Arm To - Chassis, Setback Kit To correct strong pull to left (RH drive vehicle) Change of aprox 1.0 degree in setback	<b>MPU-2718K</b>	1	Bushings	
DEL.	Radius Arm To - Diff Mount - Eccentric Kit Caster Increase kit, 51mm Outside diameter shell, 54mm Long inner tube	<b>MPU-2509K</b>	1	Outer Shells, Inner Tubes, Bushings, Inst Sheet	
DEL.	Radius Arm To - Diff Mount Bushing Crush tube length 54mm, No Outer Shell on bushing	<b>MPU-0195K</b>	1	Inner Tubes, Bushings	
DEL.	Radius Arm To - Diff Mount Bushing Crush tube length 54mm, Kit Includes bushing with outer shell	<b>MPU-0195SK</b>	1	Outer Shells, Inner Tubes, Bushings	
DEL.	Radius Arm To Chassis Mount Bushing Standard replacement kit	<b>MPU-0206K</b>	1	Bushings	



## LAND ROVER Range Rover Wagon 4WD ( Air Suspension ) -...

Página 2 (Continúa)









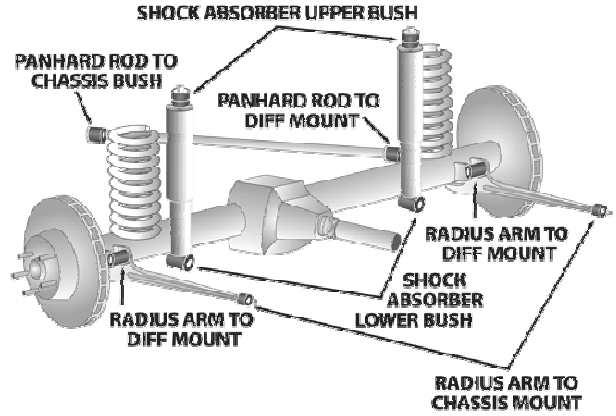
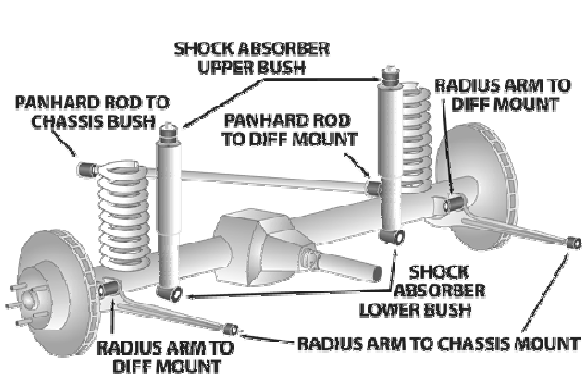

Aplicaci...	Descripción	Referencia	Kits por...	Contenido del Kit	
DEL.	Radius Arm To Chassis Mount Performance Use Performance use only	<b>MPU-3632K</b>	1	Inst Sheet, Washers, Bushings	
DEL.	Shock Absorber Upper / Lower Bushing Original shock absorber	<b>MPU-0075K</b>	1	Bushings	
DEL.	Shock Absorber Upper / Lower Bushing After-market shock absorbers	<b>MPU-1879K</b>	1	Bushings	
DEL.	Sway Bar Link Bushing Kit	<b>MPU-0078K</b>	1	Bushings	
DEL.	Sway Bar Mount Bushing 30mm bracket width, Measure bar diameter 19,20,22,24,25,27,28,30,38mm	<b>MPU-0666-__K</b>	1	Bushings	
F & R	Radius Arms & Panhard Rods Bush Kit Kit Includes 1xSPF0194K, 1xSPF0206K, 1xSPF2509K, 1xSPF0323K, 1xSPF0129K, 1xSPF0128K Kit Contains Adjustable Radius...	<b>MPK-043AADJK</b>	1		



## LAND ROVER Range Rover Wagon 4WD ( Air Suspension ) -...

Página 3 (Continúa)









Aplicaci...	Descripción	Referencia	Kits por...	Contenido del Kit	
F & R	Radius Arms & Panhard Rods Bush Kit Kit Includes 1xSPF0194K, 1xSPF0206K, 1xSPF0195K, 1xSPF0323K, 1xSPF0129K,...	<b>MPK-043AK</b>	1		
TRAS.	Shock Absorber Lower Bushing	<b>MPU-2656K</b>	1	Bushings	
TRAS.	Radius Arm To - Diff Mount Bushing	<b>MPU-0129K</b>	1	Inner Tubes, Bushings	
TRAS.	Radius Arm To Chassis Mount Bushing	<b>MPU-0323K</b>	1	Plates, Washers, Inner Tubes, Bushings	
TRAS.	Shock Absorber Lower Bushing Original shock absorber	<b>MPU-0075K</b>	1	Bushings	
TRAS.	Shock Absorber Lower Bushing After-market shock absorbers	<b>MPU-1879K</b>	1	Bushings	
TRAS.	Shock Absorber Upper Bushing	<b>MPU-0779K</b>	1	Inner Tubes, Bushings	

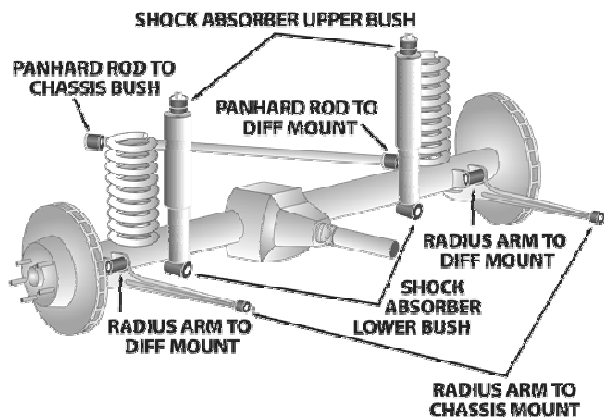
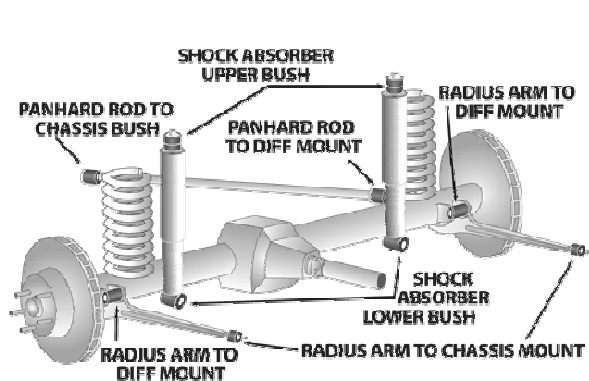

## LAND ROVER Range Rover Wagon 4WD ( Air Suspension ) -...

Página 4 (Continúa)









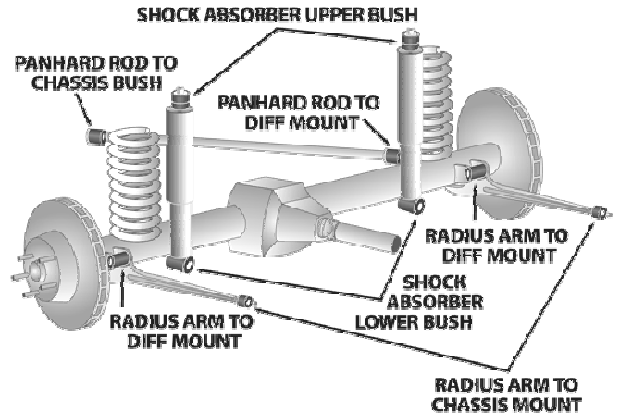
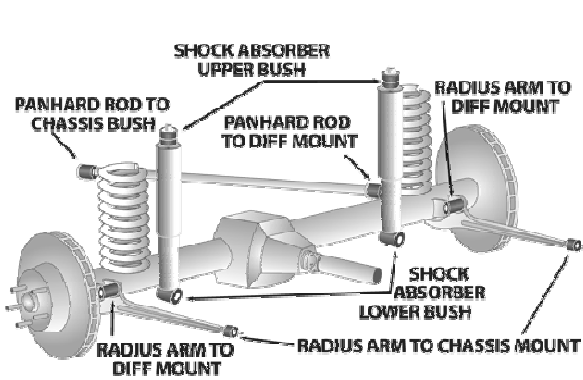

Aplicaci...	Descripción	Referencia	Kits por...	Contenido del Kit	
TRAS.	Shock Absorber Upper Bushing	<b>MPU-0078K</b>	1	Bushings	 SPF0078K
TRAS.	Sway Bar Link Bushing Kit	<b>MPU-0078K</b>	1	Bushings	 SPF0078K
TRAS.	Sway Bar Mount Bushing 30mm bracket width, Measure bar diameter 19,20,22,24,25,27,28,30,38mm	<b>MPU-0666-__K</b>	1	Bushings	
TRAS.	Trailing Arm Upper Bushing All Upper A arm to chassis bush	<b>MPU-0128K</b>	1	Inner Tubes, Bushings	 0128K



## LAND ROVER Range Rover Wagon 4WD - 5/1995 - 01/2001

Página 1



Aplicaci...	Descripción	Referencia	Kits por...	Contenido del Kit	
DEL.	Panhard Rod Bushing	<b>MPU-1803K</b>	1	Inner Tubes, Bushings	
DEL.	Radius Arm To - Chassis, Setback Kit To correct slight pull to left (RH drive vehicle) Change of aprox 0.5 degree in setback	<b>MPU-2717K</b>	1	Bushings	
DEL.	Radius Arm To - Chassis, Setback Kit To correct strong pull to left (RH drive vehicle) Change of aprox 1.0 degree in setback	<b>MPU-2718K</b>	1	Bushings	
DEL.	Radius Arm To - Diff Mount Bushing	<b>MPU-1809K</b>	1	Bushings, Inner Tubes	
DEL.	Radius Arm To Chassis Mount Bushing Standard replacement kit	<b>MPU-0206K</b>	1	Bushings	
DEL.	Radius Arm To Chassis Mount Performance Use Performance use only	<b>MPU-3632K</b>	1	Inst Sheet, Washers, Bushings	
DEL.	Shock Absorber Lower Bushing	<b>MPU-0740K</b>	1	Bushings	









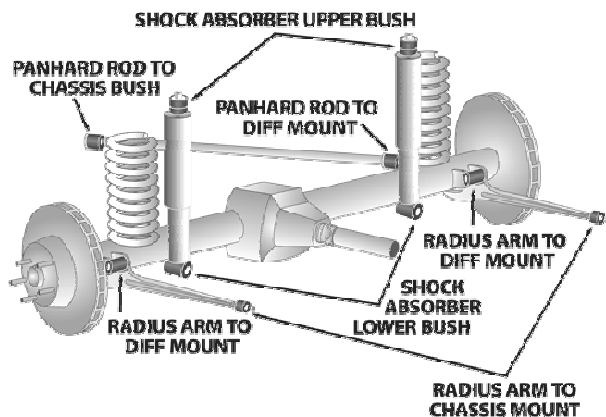
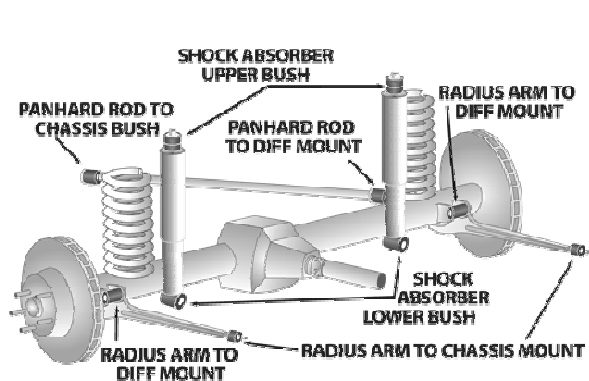

## LAND ROVER Range Rover Wagon 4WD - 5/1995 - 01/2001

Página 2 (Continúa)



Aplicaci...	Descripción	Referencia	Kits por...	Contenido del Kit	
DEL.	Sway Bar Mount To Axle Bushing Measure bar diameter 31mm available	MPU-1802-__K	1	Bushings	
F & R	Radius Arms & Panhard Rods Bush Kit	MPK-090K	1		
TRAS.	Panhard Rod Bushing	MPU-1803K	1	Inner Tubes, Bushings	
TRAS.	Radius Arm To Chassis Mount Bushing	MPU-1805K	1	Inner Tubes, Bushings	
TRAS.	Shock Absorber Lower Bushing	MPU-0740K	1	Bushings	



**LAND ROVER Range Rover Wagon 4WD - 1969 - 1/1986**

Página 1

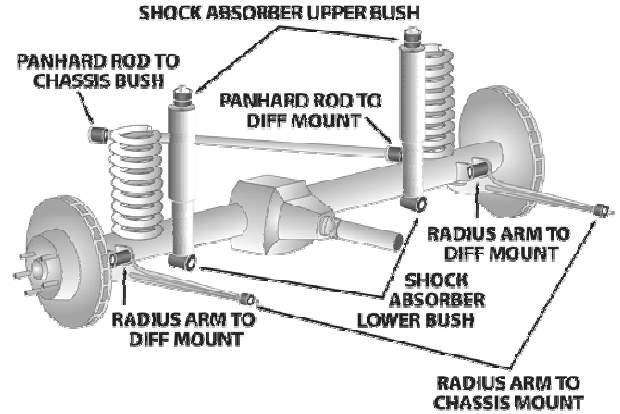
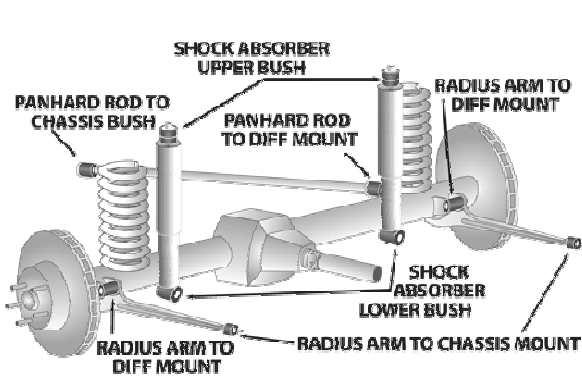

Aplicaci...	Descripción	Referencia	Kits por...	Contenido del Kit	
DEL.	Panhard Rod Bushing	<b>MPU-2156K</b>	1	Inner Tubes, Bushings	
DEL.	Radius Arm To - Diff Mount - Eccentric Kit Caster Increase Kit, 51mm OD shell, 48mm long inner tube	<b>MPU-2559K</b>	1	Outer Shells, Inner Tubes, Bushings	
DEL.	Radius Arm To - Diff Mount Bushing Crush tube length 48mm	<b>MPU-0126K</b>	1	Inner Tubes, Bushings	
DEL.	Radius Arm To Chassis Mount Bushing	<b>MPU-0127K</b>	1	Bushings	
DEL.	Shock Absorber Upper / Lower Bushing Original shock absorber	<b>MPU-0075K</b>	2	Bushings	
DEL.	Shock Absorber Upper / Lower Bushing After-market shock absorbers	<b>MPU-1879K</b>	2	Bushings	
F & R	Body Mount Kit Re-use original hardware, 2 x bushes per kit, Nominate kit quantity requirement	<b>MPU-1788K</b>	0	Bushings	



## LAND ROVER Range Rover Wagon 4WD - 1969 - 1/1986

Página 2 (Continúa)

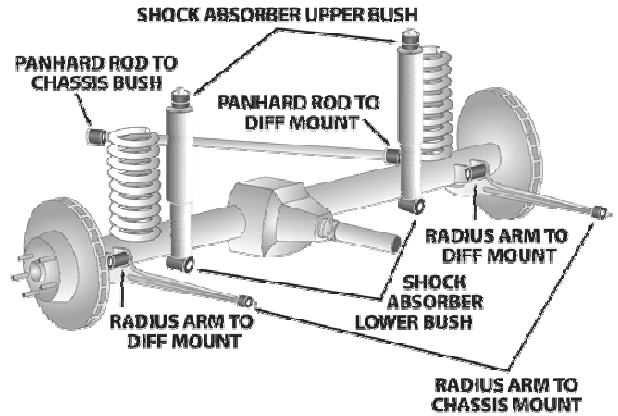
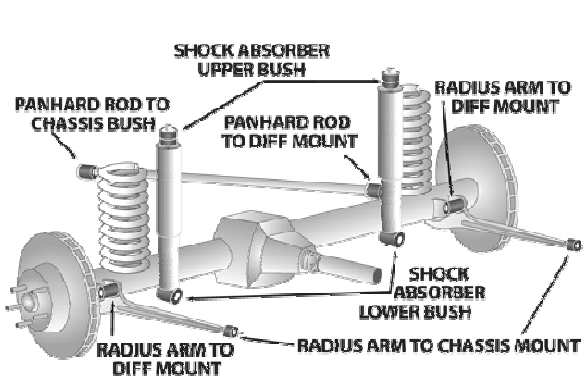



Aplicaci...	Descripción	Referencia	Kits por...	Contenido del Kit	
F & R	Radius Arms & Panhard Rods Bush Kit As per KIT0042K with eccentric radius arm to diff mount bushings	<b>MPK-042ADJK</b>	1		
F & R	Radius Arms & Panhard Rods Bush Kit Bushes to replace front and rear of vehicle	<b>MPK-042K</b>	1		
TRAS.	Radius Arm To Chassis Mount Bushing	<b>MPU-0130K</b>	1	Plates, Washers, Inner Tubes, Bushings	
TRAS.	Radius Arm To - Diff Mount Bushing	<b>MPU-0129K</b>	1	Inner Tubes, Bushings	
TRAS.	Shock Absorber Lower Bushing Original shock absorber	<b>MPU-0075K</b>	1	Bushings	
TRAS.	Shock Absorber Lower Bushing After-market shock absorbers	<b>MPU-1879K</b>	1	Bushings	
TRAS.	Shock Absorber Upper Bushing	<b>MPU-0078K</b>	1	Bushings	

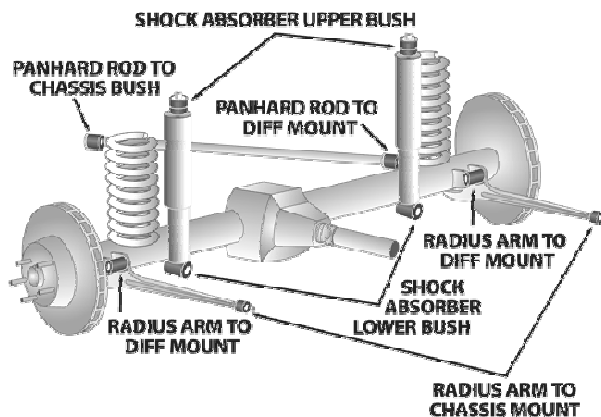
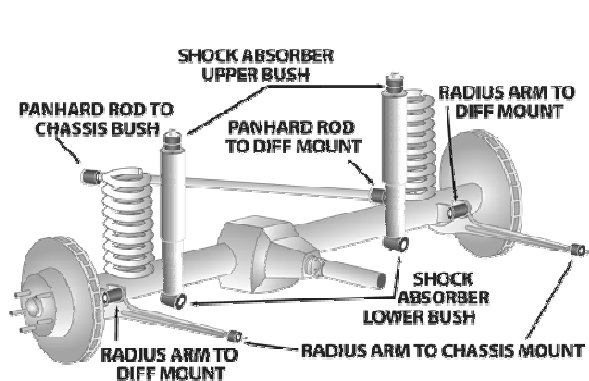

**LAND ROVER Range Rover Wagon 4WD - 1969 - 1/1986**

Página 3 (Continúa)









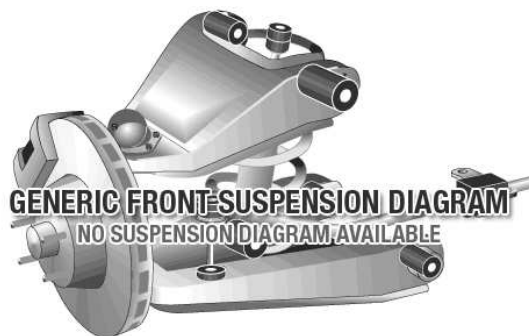
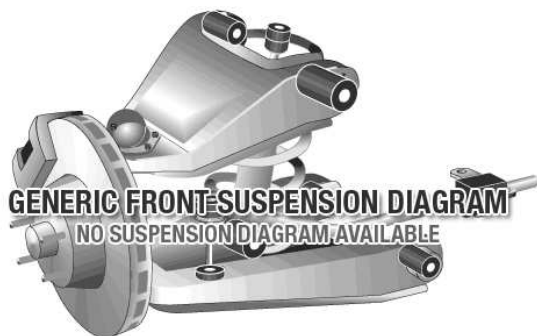

Aplicaci...	Descripción	Referencia	Kits por...	Contenido del Kit	
TRAS.	Trailing Arm Upper Bushing All Upper A arm to chassis bush	<b>MPU-0128K</b>	1	Inner Tubes, Bushings	 0128K



## LAND ROVER Range Rover Sport - 2005 - Current (2013)

Página 1





Aplicaci...	Descripción	Referencia	Kits por...	Contenido del Kit	
DEL.	Control Arm Lower-Inner Front Kit	<b>MPU-3459K</b>	1	Inst Sheet, Outer Shells, Inner Tubes, Bushings	
DEL.	Control Arm Lower-Inner Rear Kit	<b>MPU-3456K</b>	1	Inst Sheet, Inner Tubes, Bushings	
DEL.	Control Arm Upper-Inner Bushing	<b>MPU-3486K</b>	1	Inner Tubes, Bushings	
DEL.	Sway Bar Mount To Chassis Bushing AVAILABLE SIZES - 28, 34MM.	<b>MPU-3701-__K</b>	1	Bushings	
TRAS.	Sway Bar Mount To Cross-member Kit AVAILABLE SIZES - 22, 34MM.	<b>MPU-3631-__K</b>	1	Bushings	
TRAS.	Control Arm Lower Rear Bushing OE# RGX 500111	<b>MPU-3628K</b>	1	Outer Shells, Inner Tubes, Bushings	
TRAS.	Control Arm Lower-Front Bushing OE# RGX 500101	<b>MPU-3627K</b>	1	Outer Shells, Inner Tubes, Bushings	

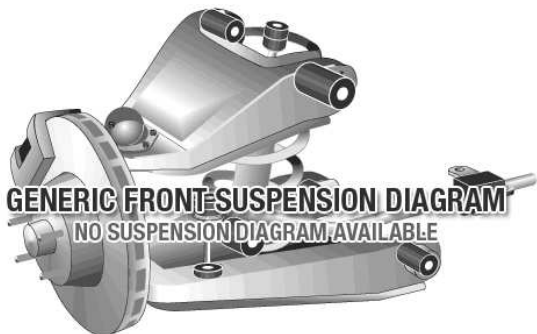

**LAND ROVER Range Rover Sport - 2005 - Current (2013)**

Página 2 (Continúa)



Aplicaci...	Descripción	Referencia	Kits por...	Contenido del Kit	
TRAS.	Control Arm Upper-Front Bushing OE# RGX 500131	<b>MPU-3630K</b>	1	Inner Tubes, Bushings	



## LAND ROVER Range Rover Wagon 4WD - 1/1986 - 2/1987

Página 1

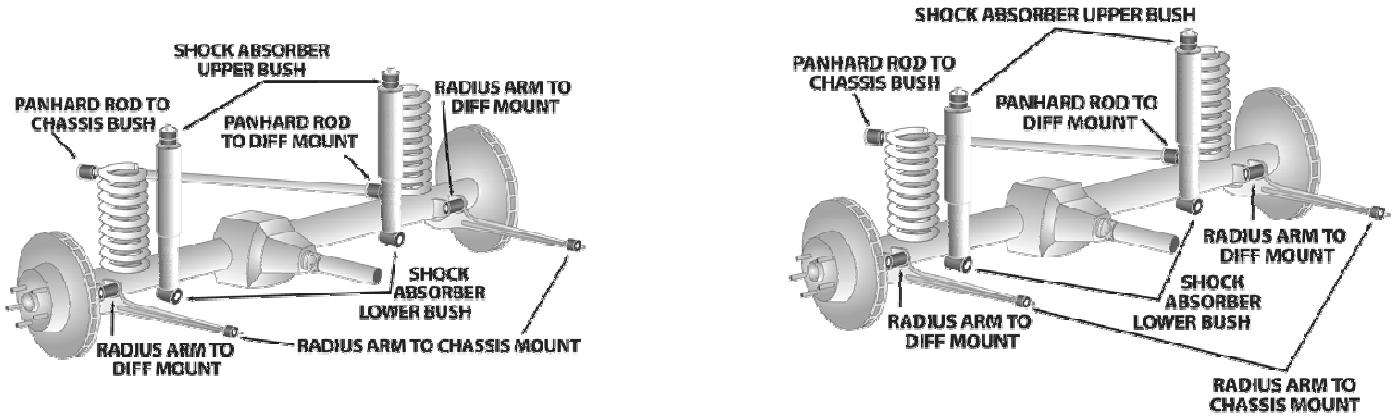

Aplicaci...	Descripción	Referencia	Kits por...	Contenido del Kit	
DEL.	Control Arm Lower-Inner Front Kit Replaces original shell part	<b>MPU-2834K</b>	1	Washers, Outer Shells, Inner Tubes, Bushings	
DEL.	Panhard Rod Bushing Tube inside diameter to suit 14mm bolt	<b>MPU-0194K</b>	1	Inner Tubes, Bushings	
DEL.	Radius Arm To - Chassis, Setback Kit To correct slight pull to left (RH drive vehicle) Change of aprox 0.5 degree in setback	<b>MPU-2717K</b>	1	Bushings	
DEL.	Radius Arm To - Chassis, Setback Kit To correct strong pull to left (RH drive vehicle) Change of aprox 1.0 degree in setback	<b>MPU-2718K</b>	1	Bushings	
DEL.	Radius Arm To - Diff Mount - Eccentric Kit Caster Increase kit, 51mm Outside diameter shell, 54mm Long inner tube	<b>MPU-2509K</b>	1	Outer Shells, Inner Tubes, Bushings, Inst Sheet	
DEL.	Radius Arm To - Diff Mount Bushing Crush tube length 54mm, No Outer Shell on bushing	<b>MPU-0195K</b>	1	Inner Tubes, Bushings	
DEL.	Radius Arm To - Diff Mount Bushing Crush tube length 54mm, Kit Includes bushing with outer shell	<b>MPU-0195SK</b>	1	Outer Shells, Inner Tubes, Bushings	



## LAND ROVER Range Rover Wagon 4WD - 1/1986 - 2/1987

Página 2 (Continúa)

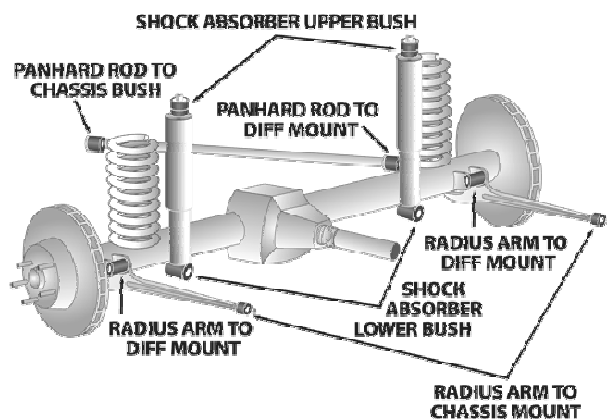
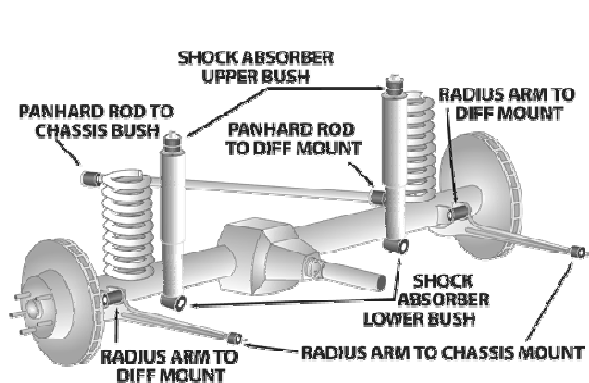

Aplicaci...	Descripción	Referencia	Kits por...	Contenido del Kit	
DEL.	Radius Arm To Chassis Mount Bushing Standard replacement kit	<b>MPU-0206K</b>	1	Bushings	
DEL.	Radius Arm To Chassis Mount Performance Use Performance use only	<b>MPU-3632K</b>	1	Inst Sheet, Washers, Bushings	
DEL.	Shock Absorber Lower Bushing Original shock absorber	<b>MPU-0075K</b>	1	Bushings	
DEL.	Shock Absorber Upper / Lower Bushing After-market shock absorbers	<b>MPU-1879K</b>	1	Bushings	
DEL.	Sway Bar Link Bushing Kit	<b>MPU-0078K</b>	1	Bushings	
DEL.	Sway Bar Mount Bushing 30mm bracket width, Measure bar diameter 19,20,22,24,25,27,28,30,38mm	<b>MPU-0666-__K</b>	1	Bushings	
F & R	Body Mount Kit Re-use original hardware, 2 x bushes per kit, Nominate kit quantity requirement	<b>MPU-1788K</b>	0	Bushings	









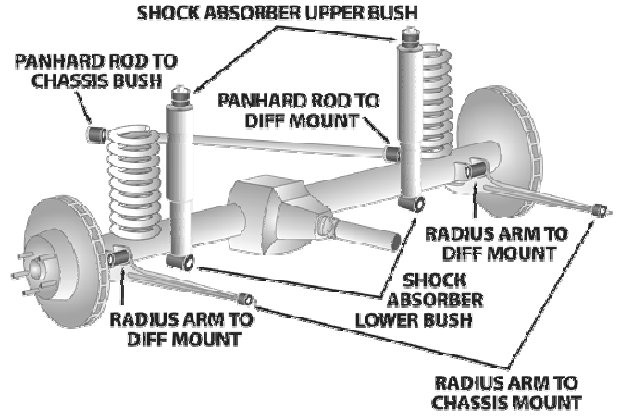
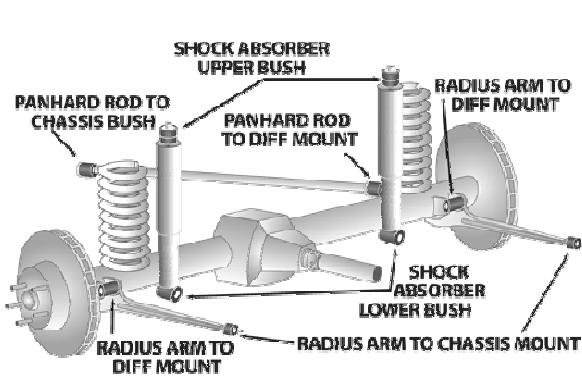

## LAND ROVER Range Rover Wagon 4WD - 1/1986 - 2/1987

Página 3 (Continúa)



Aplicaci...	Descripción	Referencia	Kits por...	Contenido del Kit	
F & R	Radius Arms & Panhard Rods Bush Kit Kit Includes 1xSPF0194K, 1xSPF0206K, 1xSPF2509K, 1xSPF0323K, 1xSPF0129K, 1xSPF0128K Kit Contains Adjustable Radius...	<b>MPK-043AADJK</b>	1		
F & R	Radius Arms & Panhard Rods Bush Kit Kit Includes 1xSPF0194K, 1xSPF0206K, 1xSPF0195K, 1xSPF0323K, 1xSPF0129K,...	<b>MPK-043AK</b>	1		
TRAS.	Sway Bar Link Bushing Kit	<b>MPU-0078K</b>	1	Bushings	
TRAS.	Radius Arm To - Diff Mount Bushing	<b>MPU-0129K</b>	1	Inner Tubes, Bushings	
TRAS.	Radius Arm To Chassis Mount Bushing	<b>MPU-0323K</b>	1	Plates, Washers, Inner Tubes, Bushings	
TRAS.	Shock Absorber Lower Bushing Original shock absorber	<b>MPU-0075K</b>	1	Bushings	



**LAND ROVER Range Rover Wagon 4WD - 1/1986 - 2/1987**

Página 4 (Continúa)

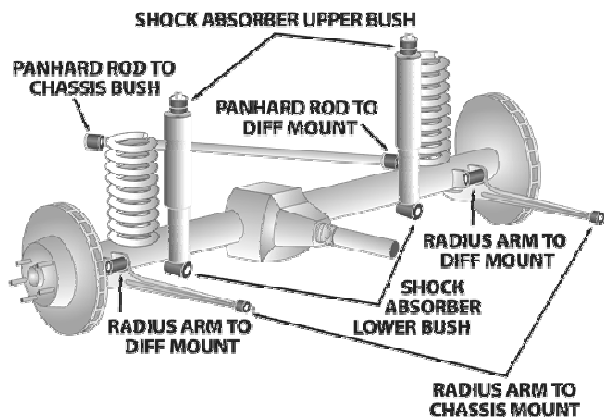
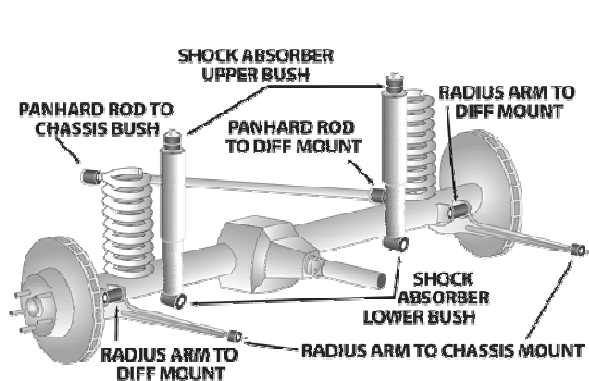







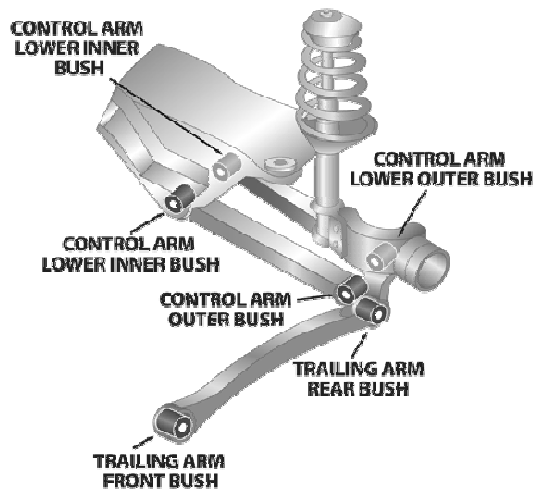
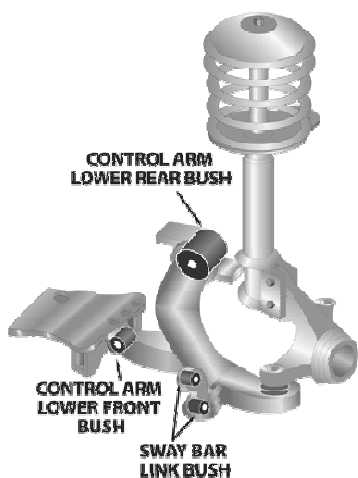

Aplicaci...	Descripción	Referencia	Kits por...	Contenido del Kit	
TRAS.	Shock Absorber Lower Bushing After-market shock absorbers	<b>MPU-1879K</b>	1	Bushings	
TRAS.	Shock Absorber Upper Bushing	<b>MPU-0779K</b>	1	Inner Tubes, Bushings	
TRAS.	Shock Absorber Upper Bushing	<b>MPU-0078K</b>	1	Bushings	
TRAS.	Sway Bar Mount Bushing 30mm bracket width, Measure bar diameter 19,20,22,24,25,27,28,30,38mm	<b>MPU-0666-__K</b>	1	Bushings	
TRAS.	Trailing Arm Upper Bushing All Upper A arm to chassis bush	<b>MPU-0128K</b>	1	Inner Tubes, Bushings	



LAND ROVER Freelander 3 & 5 Door - 3/1998 - 1999

Página 1









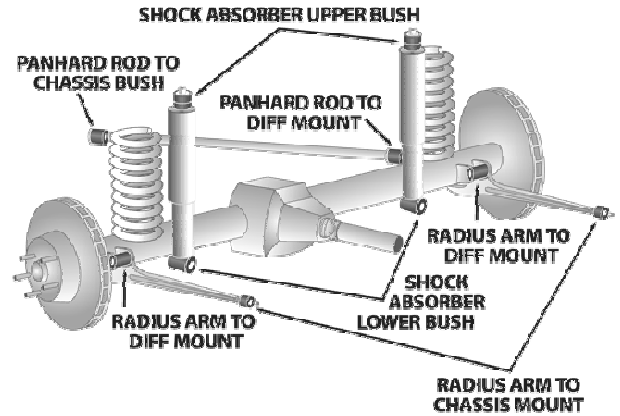
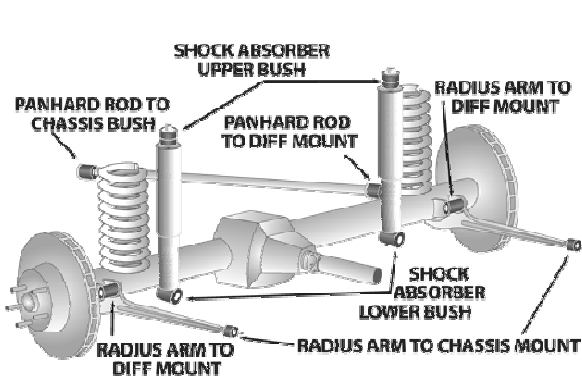

Aplicaci...	Descripción	Referencia	Kits por...	Contenido del Kit	
DEL.	Control Arm Lower-Inner Front Kit	MPU-1759K	1	Bushings, Inner Tubes	
DEL.	Sway Bar Mount To Chassis Bushing Measure bar diameter 20mm available	MPU-1763-_K	1	Bushings	
TRAS.	Control Arm Front Bushing Front control arm outer bush	MPU-1761K	1	Inner Tubes, Bushings	
TRAS.	Control Arm Rear Bushing Rear control arm inner & outer bushes	MPU-1761K	2	Inner Tubes, Bushings	
TRAS.	Control Arm-Bush Kit Front control arm inner bush.	MPU-1762K	1	Inner Tubes, Bushings	
TRAS.	Trailing Arm - Front Bushing	MPU-1760K	1	Inner Tubes, Bushings	



## LAND ROVER Discovery Series 2 - 3/1999 - 2005

Página 1









Aplicaci...	Descripción	Referencia	Kits por...	Contenido del Kit	
DEL.	Panhard Rod Bushing	<b>MPU-1803K</b>	1	Inner Tubes, Bushings	
DEL.	Radius Arm To - Diff Mount - Eccentric Kit Caster Increase kit, 65mm OD shell, 70mm long inner tube, 2 degree of adjustment	<b>MPU-2560K</b>	1	Bushings, Inner Tubes, Outer Shells	
DEL.	Radius Arm To - Diff Mount - Eccentric Kit Caster Increase kit, 65mm OD shell, 70mm long inner tube, 3 degree of adjustment	<b>MPU-2560XK</b>	1	Bushings, Inner Tubes, Outer Shells	
DEL.	Radius Arm To - Diff Mount Bushing	<b>MPU-2134K</b>	1	Inner Tubes, Bushings	
DEL.	Radius Arm To Chassis Mount Bushing Standard replacement	<b>MPU-2128K</b>	1	Washers, Inner Tubes, Bushings	
DEL.	Radius Arm To Chassis Mount Bushing Extreme Use Only	<b>MPU-2128-80K</b>	1	Washers, Inner Tubes, Bushings	
DEL.	Sway Bar Link Bushing Kit	<b>MPU-0078K</b>	1	Bushings	

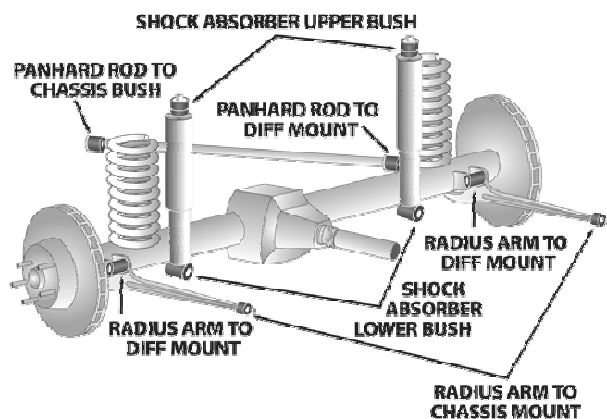
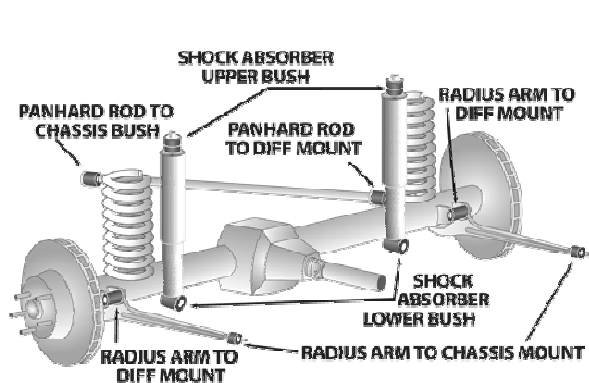

## LAND ROVER Discovery Series 2 - 3/1999 - 2005

Página 2 (Continúa)









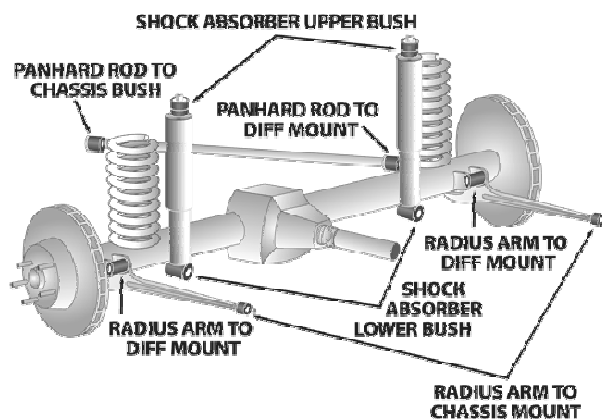
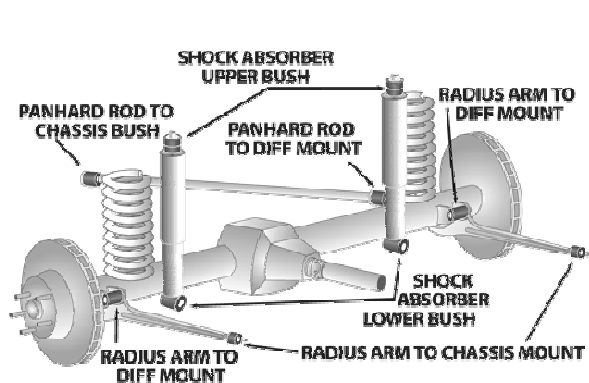

Aplicaci...	Descripción	Referencia	Kits por...	Contenido del Kit	
DEL.	Sway Bar Mount To Chassis Bushing Measure bar diameter 19,30,35mm available	MPU-2136-__K	1	Bushings	
TRAS.	Sway Bar Mount To Chassis Bushing Measure bar diameter 19,30,35mm available	MPU-2136-__K	1	Bushings	
TRAS.	Radius Arm To - Diff Mount Bushing	MPU-2135K	1	Inner Tubes, Bushings	
TRAS.	Radius Arm To Chassis Mount Bushing Standard replacement	MPU-2128K	1	Washers, Inner Tubes, Bushings	
TRAS.	Radius Arm To Chassis Mount Bushing Extreme use only	MPU-2128-80K	1	Washers, Inner Tubes, Bushings	



## LAND ROVER Discovery Series 1 - 3/1991 - 1999

Página 1









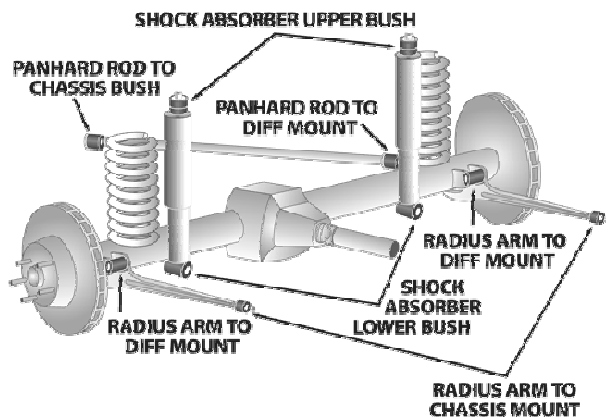
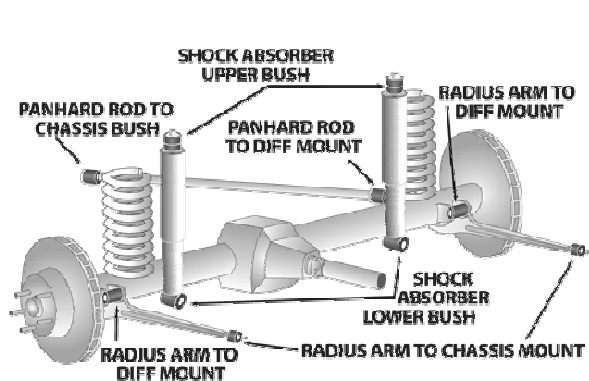

Aplicaci...	Descripción	Referencia	Kits por...	Contenido del Kit	
DEL.	Panhard Rod Bushing Tube inside diameter to suit 14mm bolt	<b>MPU-0194K</b>	1	Inner Tubes, Bushings	
DEL.	Radius Arm To - Chassis, Setback Kit To correct slight pull to left (RH drive vehicle) Change of aprox 0.5 degree in setback	<b>MPU-2717K</b>	1	Bushings	
DEL.	Radius Arm To - Chassis, Setback Kit To correct strong pull to left (RH drive vehicle) Change of aprox 1.0 degree in setback	<b>MPU-2718K</b>	1	Bushings	
DEL.	Radius Arm To - Diff Mount - Eccentric Kit Caster Increase kit, 51mm Outside diameter shell, 54mm Long inner tube	<b>MPU-2509K</b>	1	Outer Shells, Inner Tubes, Bushings, Inst Sheet	
DEL.	Radius Arm To - Diff Mount Bushing Crush tube length 54mm, No Outer Shell on bushing	<b>MPU-0195K</b>	1	Inner Tubes, Bushings	
DEL.	Radius Arm To - Diff Mount Bushing Crush tube length 54mm, Kit Includes bushing with outer shell	<b>MPU-0195SK</b>	1	Outer Shells, Inner Tubes, Bushings	
DEL.	Radius Arm To Chassis Mount Bushing Standard replacement kit	<b>MPU-0206K</b>	1	Bushings	



## LAND ROVER Discovery Series 1 - 3/1991 - 1999

Página 2 (Continúa)









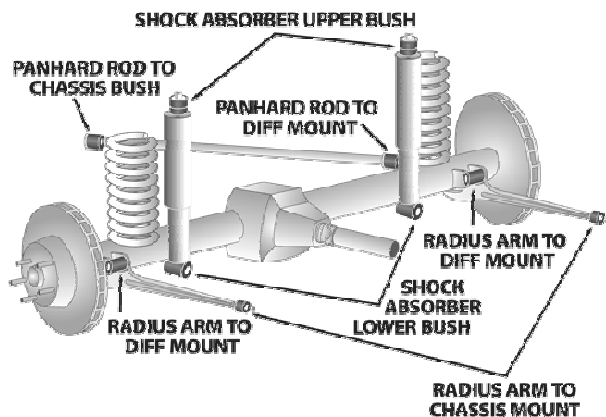
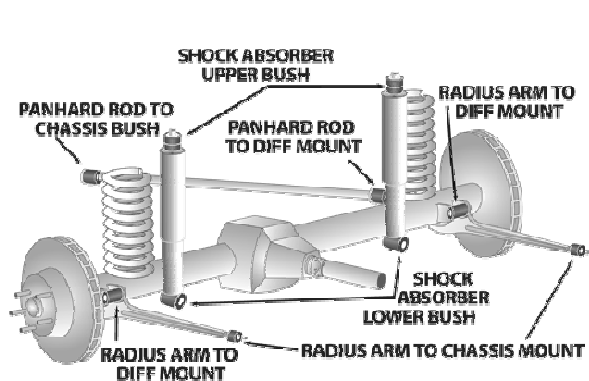

Aplicaci...	Descripción	Referencia	Kits por...	Contenido del Kit	
DEL.	Radius Arm To Chassis Mount Performance Use Performance use only	<b>MPU-3632K</b>	1	Inst Sheet, Washers, Bushings	
DEL.	Shock Absorber Bushing	<b>MPU-0078K</b>	1	Bushings	
DEL.	Shock Absorber Upper / Lower Bushing Original shock absorber	<b>MPU-0075K</b>	2	Bushings	
DEL.	Shock Absorber Upper / Lower Bushing After-market shock absorbers	<b>MPU-1879K</b>	2	Bushings	
DEL.	Sway Bar Mount Bushing 30mm bracket width, Measure bar diameter 19,20,22,24,25,27,28,30,38mm	<b>MPU-0666-__K</b>	1	Bushings	
F & R	Radius Arms & Panhard Rods Bush Kit Kit Includes 1xSPF0194K, 1xSPF0206K, 1xSPF0195K, 1xSPF0323K, 1xSPF0129K,...	<b>MPK-043AK</b>	1		
F & R	Radius Arms & Panhard Rods Bush Kit Kit Includes 1xSPF0194K, 1xSPF0206K, 1xSPF2509K, 1xSPF0323K, 1xSPF0129K,...	<b>MPK-043AADJK</b>	1		



## LAND ROVER Discovery Series 1 - 3/1991 - 1999

Página 3 (Continúa)



Aplicaci...	Descripción	Referencia	Kits por...	Contenido del Kit	
F & R	Arm To Diff Mount Bushings	MPK-043AADJK	1		
TRAS.	Radius Arm To - Diff Mount Bushing	MPU-0129K	1	Inner Tubes, Bushings	
TRAS.	Radius Arm To Chassis Mount Bushing	MPU-0323K	1	Plates, Washers, Inner Tubes, Bushings	
TRAS.	Shock Absorber Lower Bushing Original shock absorber	MPU-0075K	1	Bushings	
TRAS.	Shock Absorber Lower Bushing After-market shock absorbers	MPU-1879K	1	Bushings	
TRAS.	Shock Absorber Lower Bushing	MPU-2656K	1	Bushings	
TRAS.	Shock Absorber Upper Bushing 1992 on	MPU-0779K	1	Inner Tubes, Bushings	



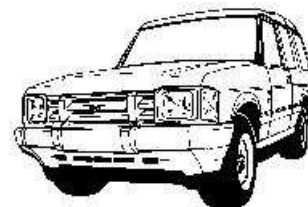

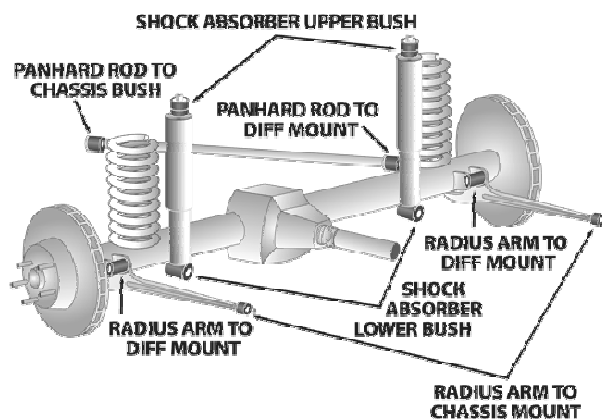
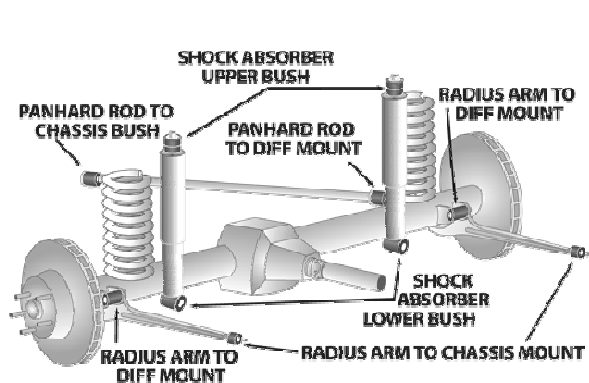

## LAND ROVER Discovery Series 1 - 3/1991 - 1999

Página 4 (Continúa)









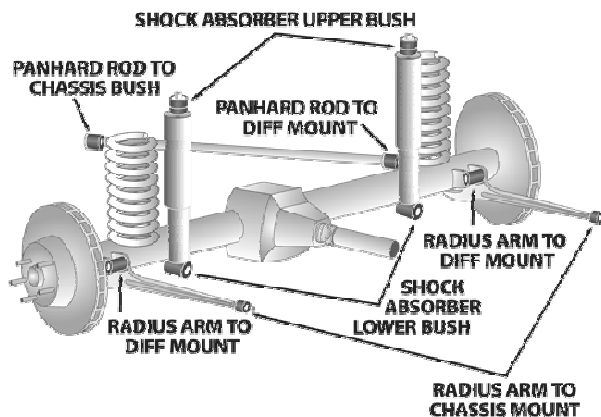
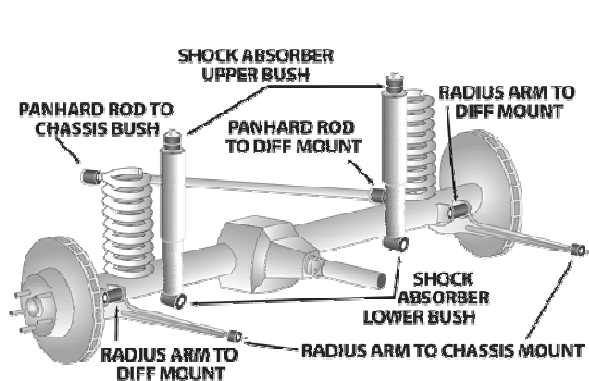

Aplicaci...	Descripción	Referencia	Kits por...	Contenido del Kit	
TRAS.	Sway Bar Mount Bushing 30mm bracket width, Measure bar diameter 19,20,22,24,25,27,28,30,38mm	MPU-0666-__K	1	Bushings	
TRAS.	Trailing Arm Upper Bushing All Upper A arm to chassis bush	MPU-0128K	1	Inner Tubes, Bushings	



**LAND ROVER Discovery Series 3 - 2005-2009**

Página 1





Aplicaci...	Descripción	Referencia	Kits por...	Contenido del Kit	
DEL.	Control Arm Lower-Inner Front Kit	<b>MPU-3459K</b>	1	Inst Sheet, Outer Shells, Inner Tubes, Bushings	
DEL.	Control Arm Lower-Inner Rear Kit	<b>MPU-3456K</b>	1	Inst Sheet, Inner Tubes, Bushings	
DEL.	Control Arm Upper-Inner Bushing	<b>MPU-3486K</b>	1	Inner Tubes, Bushings	
DEL.	Sway Bar Mount To Chassis Bushing AVAILABLE SIZES - 28, 34MM.	<b>MPU-3701-__K</b>	1	Bushings	
TRAS.	Control Arm Lower Rear Bushing	<b>MPU-3628K</b>	1	Outer Shells, Inner Tubes, Bushings	
TRAS.	Control Arm Lower-Front Bushing OE# RGX 500101	<b>MPU-3627K</b>	1	Outer Shells, Inner Tubes, Bushings	
TRAS.	Control Arm Upper-Front Bushing OE# RGX 500131	<b>MPU-3630K</b>	1	Inner Tubes, Bushings	

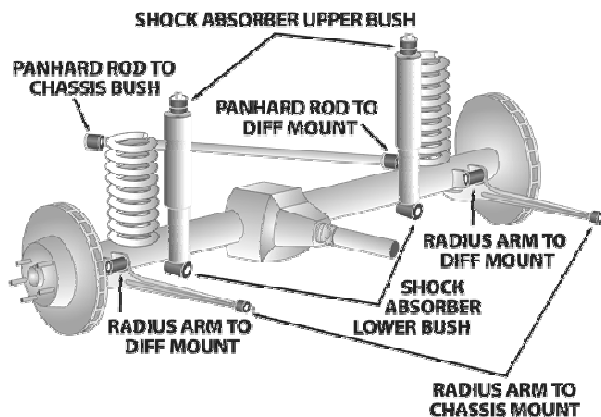
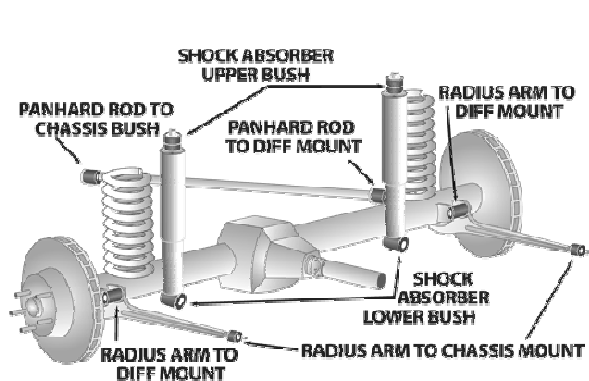

**LAND ROVER Discovery Series 3 - 2005-2009**

Página 2 (Continúa)









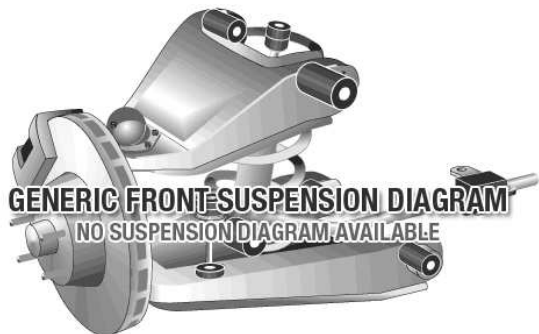

Aplicaci...	Descripción	Referencia	Kits por...	Contenido del Kit	
TRAS.	Sway Bar Mount To Chassis Bushing AVAILABLE SIZES - 22, 34MM.	<b>MPU-3631-__K</b>	1	Bushings	



## LAND ROVER Discovery Series 4 - 2009 - Current (2013)

Página 1









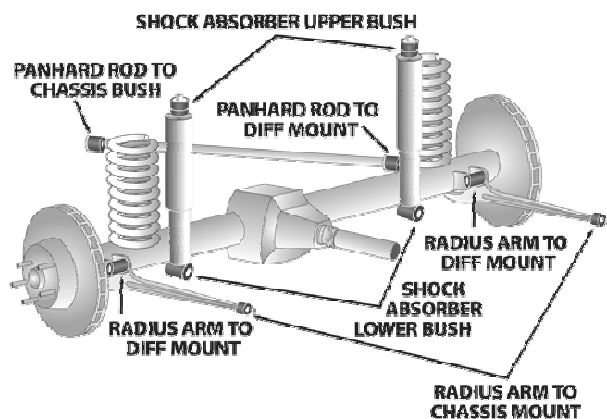
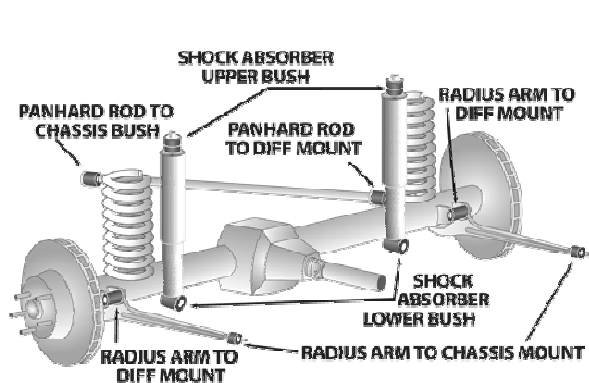

Aplicaci...	Descripción	Referencia	Kits por...	Contenido del Kit	
DEL.	Control Arm Upper-Inner Bushing	<b>MPU-3486K</b>	1	Inner Tubes, Bushings	
DEL.	Sway Bar Mount To Chassis Bushing AVAILABLE SIZES - 28, 34MM.	<b>MPU-3701-__K</b>	1	Bushings	
TRAS.	Control Arm Lower Rear Bushing	<b>MPU-3628K</b>	1	Outer Shells, Inner Tubes, Bushings	
TRAS.	Control Arm Lower-Front Bushing	<b>MPU-3627K</b>	1	Outer Shells, Inner Tubes, Bushings	
TRAS.	Control Arm Upper-Front Bushing	<b>MPU-3630K</b>	1	Inner Tubes, Bushings	
TRAS.	Sway Bar Mount To Chassis Bushing AVAILABLE SIZES - 22, 34MM.	<b>MPU-3631-__K</b>	1	Bushings	



LAND ROVER Landrover Defender 2002 - On Late Defender -...

Página 1









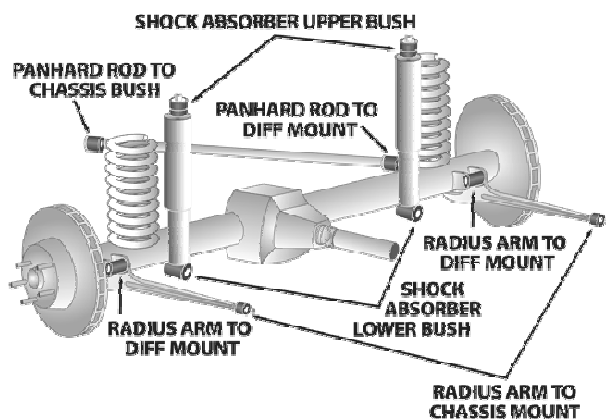
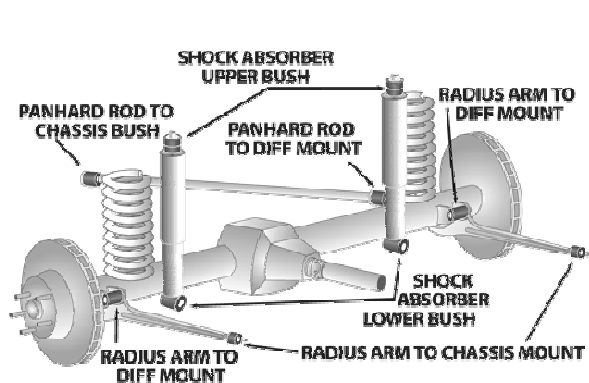

Aplicaci...	Descripción	Referencia	Kits por...	Contenido del Kit	
DEL.	Panhard Rod Bushing Chassis # prefix YA on	<b>MPU-1803K</b>	1	Inner Tubes, Bushings	
DEL.	Sway Bar Mount Bushing 30mm bracket width, Measure bar diameter 19,20,22,24,25,27,28,30,38mm	<b>MPU-0666-__K</b>	1	Bushings	
DEL.	Radius Arm To - Chassis, Setback Kit To correct slight pull to left (RH drive vehicle) Change of aprox 0.5 degree in setback	<b>MPU-2717K</b>	1	Bushings	
DEL.	Radius Arm To - Chassis, Setback Kit To correct strong pull to left (RH drive vehicle) Change of aprox 1.0 degree in setback	<b>MPU-2718K</b>	1	Bushings	
DEL.	Radius Arm To - Diff Mount - Eccentric Kit Caster Increase, 51mm outside diameter shell with inner tube length of 54mm	<b>MPU-2509K</b>	1	Outer Shells, Inner Tubes, Bushings, Inst Sheet	
DEL.	Radius Arm To - Diff Mount Bushing Crush tube length 54mm, Kit includes bushing with outes shell	<b>MPU-0195SK</b>	1	Outer Shells, Inner Tubes, Bushings	
DEL.	Radius Arm To - Diff Mount Bushing Crush tube length 54mm	<b>MPU-0195K</b>	1	Inner Tubes, Bushings	



LAND ROVER Landrover Defender 2002 - On Late Defender -...

Página 2 (Continúa)









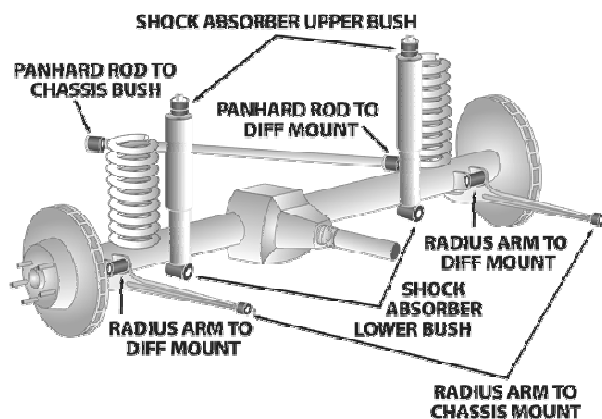
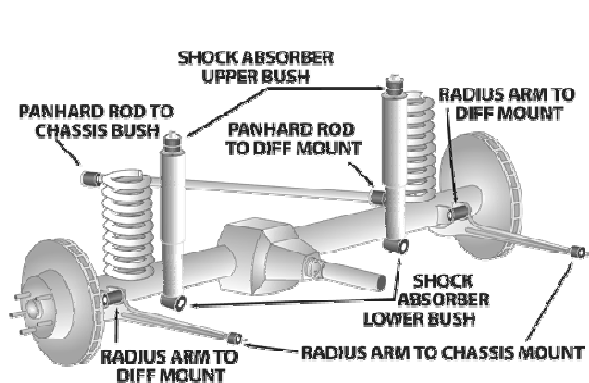

Aplicaci...	Descripción	Referencia	Kits por...	Contenido del Kit	
DEL.	Radius Arm To Chassis Mount Bushing Standard replacement kit	MPU-0206K	1	Bushings	
DEL.	Radius Arm To Chassis Mount Performance Use Performance use only	MPU-3632K	1	Inst Sheet, Washers, Bushings	
DEL.	Shock Absorber Upper / Lower Bushing Aftermarket shock absorbers	MPU-1879K	2	Bushings	
DEL.	Shock Absorber Upper / Lower Bushing Original shock only	MPU-0075K	2	Bushings	
DEL.	Sway Bar Link Bushing Kit	MPU-0078K	1	Bushings	
F & R	Radius Arms & Panhard Rods Bush Kit Kit includes 1xSPF1803K, 1xSPF0206K, 1xSPF2509K, 1xSPF0323K, 1xSPF0129K, 1xSPF0128K, Adjustable Radius Arm to Diff...	MPK-043CADJK	1		



## LAND ROVER Landrover Defender 2002 - On Late Defender -...

Página 3 (Continúa)









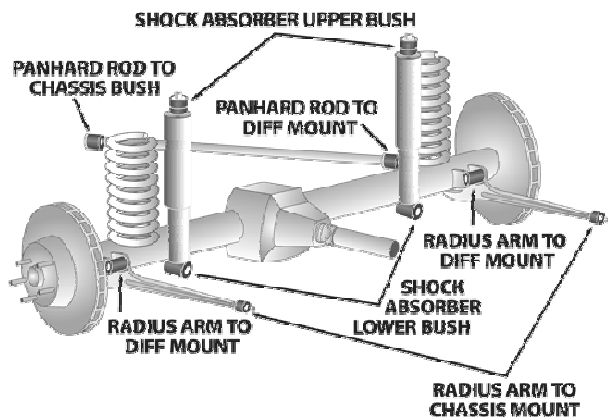
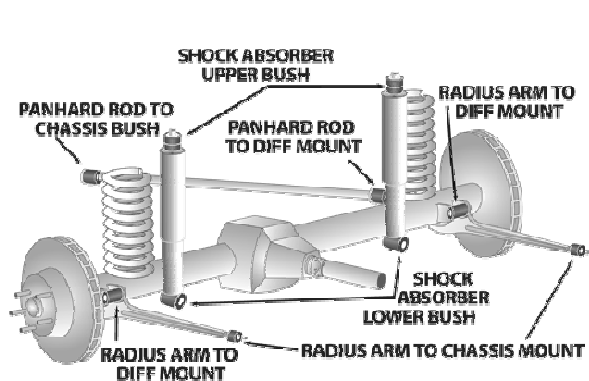

Aplicaci...	Descripción	Referencia	Kits por...	Contenido del Kit	
F & R	Radius Arms & Panhard Rods Bush Kit Kit includes 1xSPF1803K, 1xSPF0206K, 1xSPF0195K, 1xSPF0323K, 1xSPF0129K,...	<b>MPK-043CK</b>	1		
TRAS.	Radius Arm To - Diff Mount Bushing	<b>MPU-0129K</b>	1	Inner Tubes, Bushings	
TRAS.	Radius Arm To Chassis Mount Bushing	<b>MPU-0323K</b>	1	Plates, Washers, Inner Tubes, Bushings	
TRAS.	Shock Absorber Lower Bushing From XA159807	<b>MPU-2656K</b>	1	Bushings	
TRAS.	Shock Absorber Lower Bushing Aftermarket shock absorbers	<b>MPU-1879K</b>	1	Bushings	
TRAS.	Shock Absorber Lower Bushing Original shock only	<b>MPU-0075K</b>	1	Bushings	
TRAS.	Shock Absorber Lower Bushing	<b>MPU-2656K</b>	1	Bushings	



LAND ROVER Landrover Defender 2002 - On Late Defender -...

Página 4 (Continúa)



Aplicaci...	Descripción	Referencia	Kits por...	Contenido del Kit	
TRAS.	Shock Absorber Upper Bushing Original shock absorbers	MPU-0779K	1	Inner Tubes, Bushings	
TRAS.	Shock Absorber Upper Bushing Aftermarket shock absorber	MPU-0078K	1	Bushings	
TRAS.	Sway Bar Link Bushing Kit	MPU-0078K	1	Bushings	
TRAS.	Sway Bar Mount Bushing 30mm bracket width, Measure bar diameter 19,20,22,24,25,27,28,30,38mm	MPU-0666-__K	1	Bushings	
TRAS.	Sway Bar Mount Bushing 38mm bracket width, Measure bar diameter 18,19 & 28.5mm available	MPU-2303-__K	1	Bushings	
TRAS.	Trailing Arm Upper Bushing All Upper A arm to Chassis bushing kit	MPU-0128K	1	Inner Tubes, Bushings	









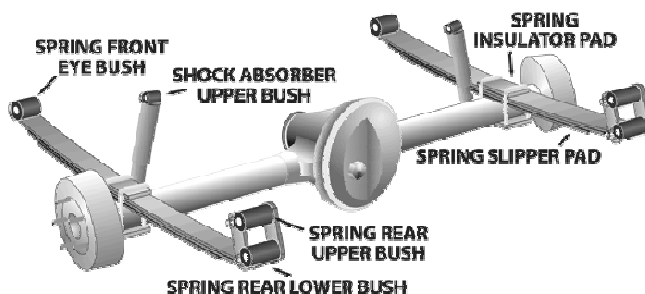
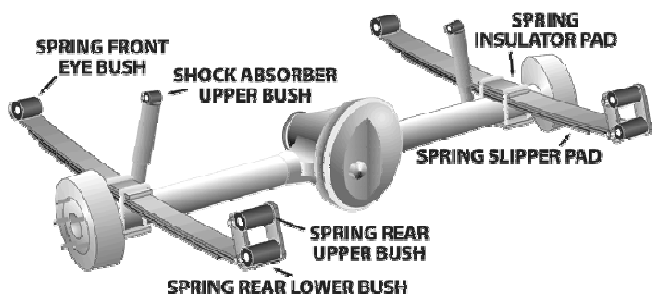



**LAND ROVER Landrover Series 2, 2A & 3 Series 2, 2A & 3 -...**

Página 1









Aplicaci...	Descripción	Referencia	Kits por...	Contenido del Kit	
DEL.	Shock Absorber Bushing	<b>MPU-0078K</b>	2	Bushings	 SPF0078K
DEL.	Spring Front Eye Bushing	<b>MPU-2154K</b>	1	Inner Tubes, Bushings	
DEL.	Spring Rear Eye Bushing	<b>MPU-2154K</b>	1	Inner Tubes, Bushings	
DEL.	Spring Shackle Upper Bushing OD 30mm	<b>MPU-0212K</b>	1	Bushings, Inner Tubes	 0212K
DEL.	Spring Shackle Upper Bushing OD 38mm	<b>MPU-2155K</b>	1	Bushings, Inner Tubes	 2155K
F & R	Leaf Spring Bushing All SPF075Kx1,SPF078Kx3,SPF2154Kx5,SPF2155Kx1	<b>MPK-041K</b>	1		
TRAS.	Leaf Spring Bushing All	<b>MPU-2154K</b>	3	Inner Tubes, Bushings	

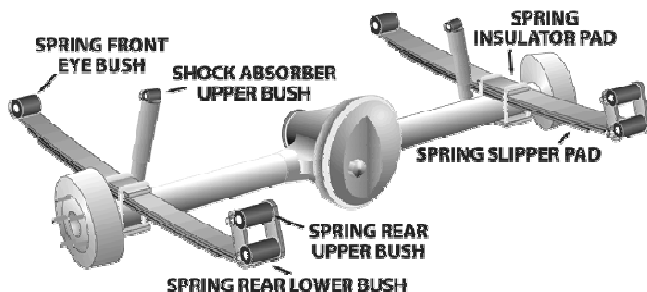
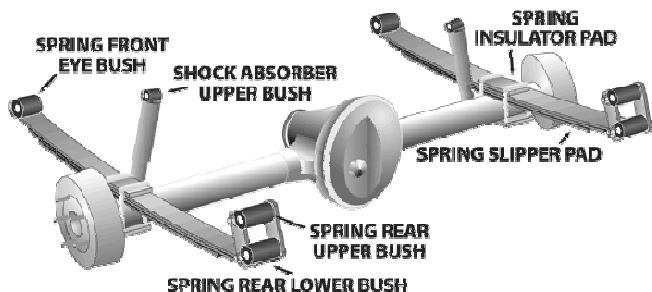

**LAND ROVER Landrover Series 2, 2A & 3 Series 2, 2A & 3 -...**

Página 2 (Continúa)









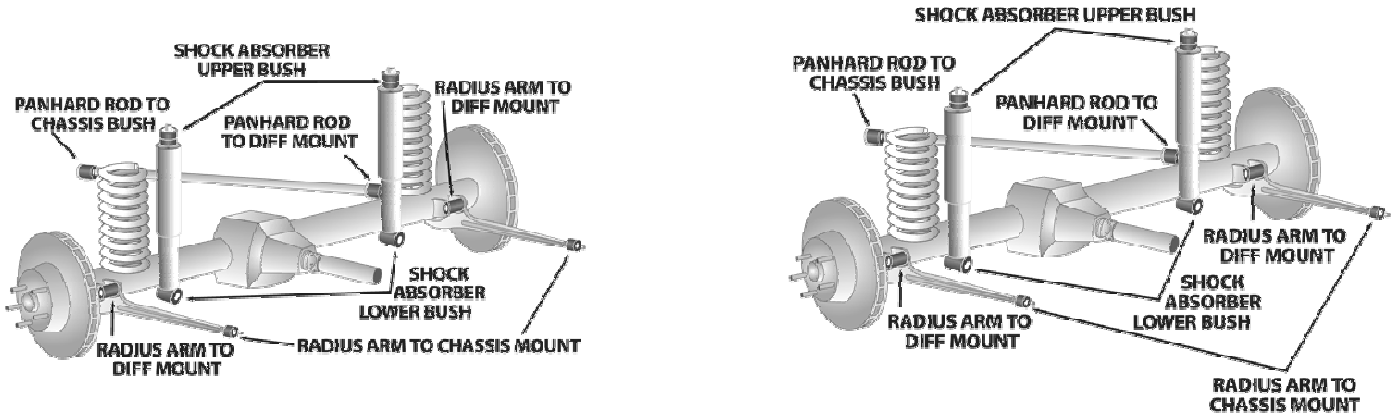

Aplicaci...	Descripción	Referencia	Kits por...	Contenido del Kit	
TRAS.	Shock Absorber Lower Bushing Original shock absorber - LWB Series 3 only	<b>MPU-0075K</b>	1	Bushings	
TRAS.	Shock Absorber Lower Bushing After-market shock absorbers	<b>MPU-1879K</b>	1	Bushings	
TRAS.	Shock Absorber Upper / Lower Bushing Short wheel Base	<b>MPU-0078K</b>	2	Bushings	
TRAS.	Shock Absorber Upper Bushing Long wheel base	<b>MPU-0078K</b>	1	Bushings	



LAND ROVER Landrover 90,110,130 Defender & County - KA...

Página 1



Aplicaci...	Descripción	Referencia	Kits por...	Contenido del Kit	
DEL.	Radius Arm To - Chassis, Setback Kit To correct slight pull to left (RH drive vehicle) Change of aprox 0.5 degree in setback	MPU-2717K	1	Bushings	
DEL.	Radius Arm To - Chassis, Setback Kit To correct strong pull to left (RH drive vehicle) Change of aprox 1.0 degree in setback	MPU-2718K	1	Bushings	
DEL.	Radius Arm To - Diff Mount - Eccentric Kit Caster Increase Kit, 51mm OD shell, 48mm long inner tube	MPU-2559K	1	Outer Shells, Inner Tubes, Bushings	
DEL.	Radius Arm To - Diff Mount Bushing Crush tube length 48mm	MPU-0126K	1	Inner Tubes, Bushings	
DEL.	Radius Arm To Chassis Mount Bushing Standard replacement kit	MPU-0206K	1	Bushings	
DEL.	Radius Arm To Chassis Mount Performance Use Performance use only	MPU-3632K	1	Inst Sheet, Washers, Bushings	
DEL.	Shock Absorber Upper / Lower Bushing After-market shock absorbers	MPU-1879K	2	Bushings	



LAND ROVER Landrover 90,110,130 Defender & County - KA...

Página 2 (Continúa)

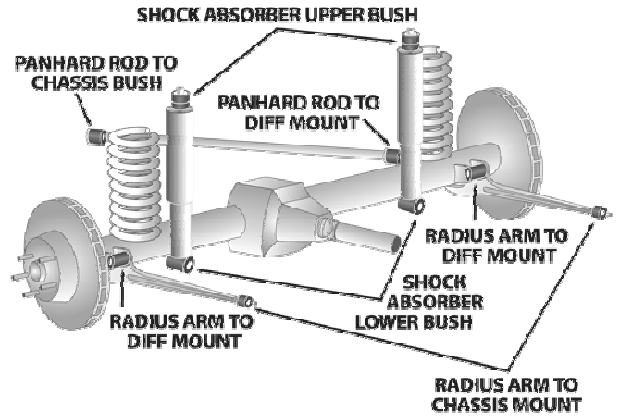
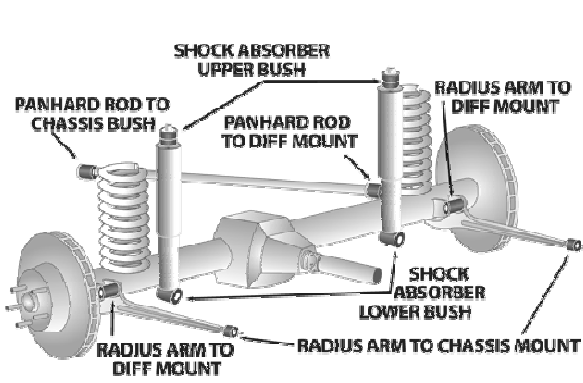







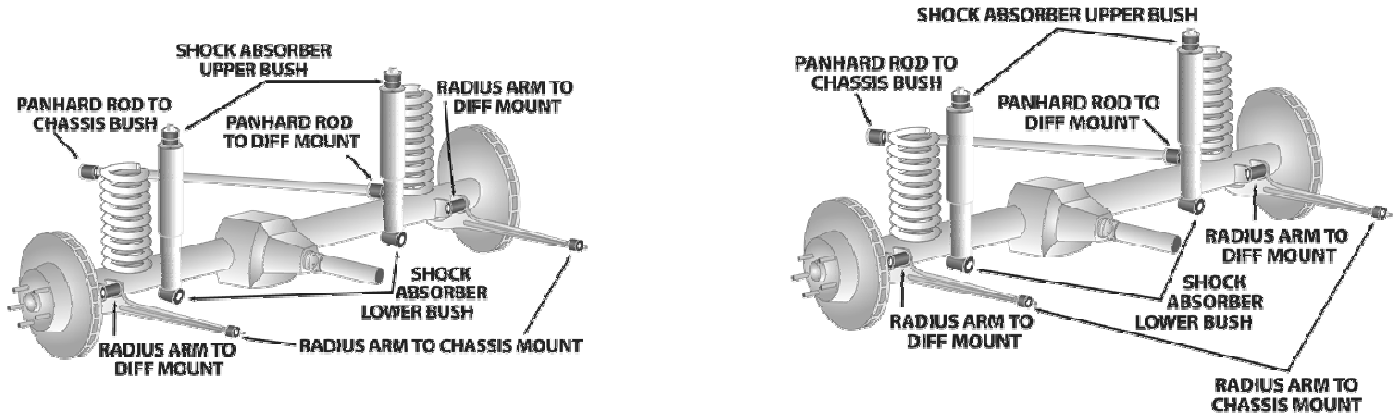

Aplicaci...	Descripción	Referencia	Kits por...	Contenido del Kit	
DEL.	Shock Absorber Upper / Lower Bushing Original shocks only	MPU-0075K	2	Bushings	
DEL.	Sway Bar Link Bushing Kit	MPU-0078K	1	Bushings	
DEL.	Sway Bar Mount Bushing 30mm bracket width, Measure bar diameter 19,20,22,24,25,27,28,30,38mm	MPU-0666-__K	1	Bushings	
DEL.	Panhard Rod Bushing Tube inside diameter to suit 14mm bolt	MPU-0194K	1	Inner Tubes, Bushings	
F & R	Radius Arms & Panhard Rods Bush Kit Kit includes SPF0194Kx1, SPF0206Kx1, SPF0126Kx1, SPF0323Kx1, SPF0129Kx1 & SPF0128Kx1	MPK-043BK	1		
F & R	Radius Arms & Panhard Rods Bush Kit Kit includes SPF0194Kx1, SPF0206Kx1, SPF02559Kx1, SPF0323Kx1, SPF0129Kx1 & SPF0128Kx1 Kit Contains Adjustable Radius Arm To Diff.	MPK-043BADJK	1		



LAND ROVER Landrover 90,110,130 Defender & County - KA...

Página 3 (Continúa)







Aplicaci...	Descripción	Referencia	Kits por...	Contenido del Kit	
TRAS.	Radius Arm To - Diff Mount Bushing	<b>MPU-0129K</b>	1	Inner Tubes, Bushings	
TRAS.	Radius Arm To Chassis Mount Bushing	<b>MPU-0323K</b>	1	Plates, Washers, Inner Tubes, Bushings	
TRAS.	Shock Absorber Lower Bushing After-market shock absorbers	<b>MPU-1879K</b>	1	Bushings	
TRAS.	Shock Absorber Lower Bushing Original shock only	<b>MPU-0075K</b>	1	Bushings	
TRAS.	Shock Absorber Upper Bushing	<b>MPU-0779K</b>	1	Inner Tubes, Bushings	
TRAS.	Sway Bar Link Bushing Kit	<b>MPU-0078K</b>	1	Bushings	
TRAS.	Sway Bar Mount Bushing 30mm bracket width, Measure bar diameter 19,20,22,24,25,27,28,30,38mm	<b>MPU-0666-__K</b>	1	Bushings	

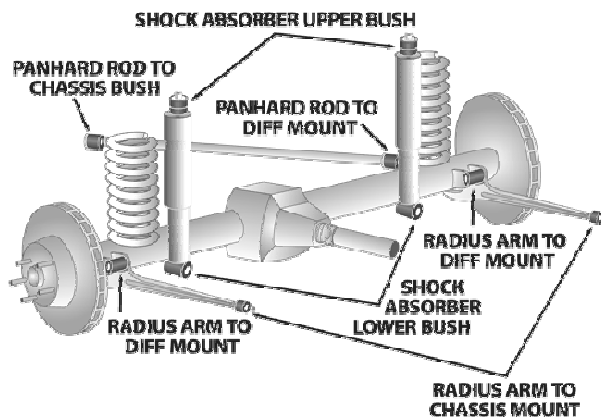
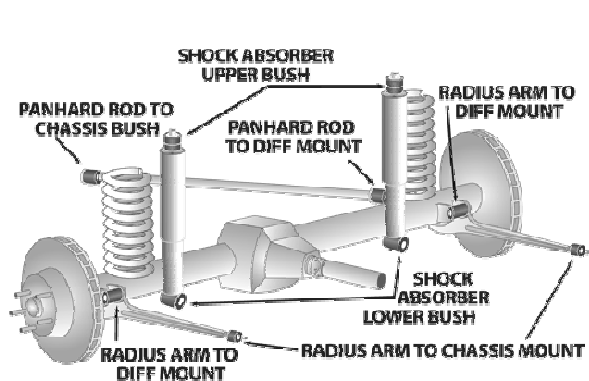

LAND ROVER Landrover 90,110,130 Defender & County - KA...

Página 4 (Continúa)









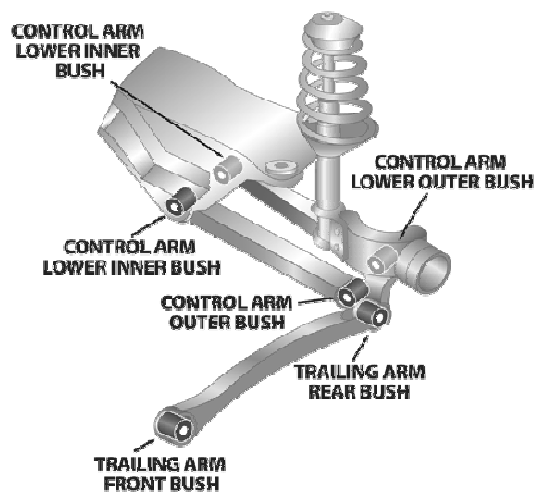
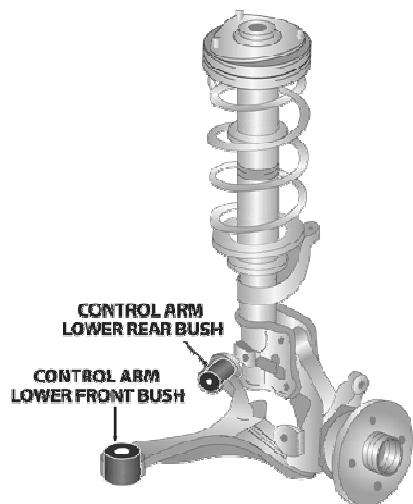

Aplicaci...	Descripción	Referencia	Kits por...	Contenido del Kit	
TRAS.	Sway Bar Mount Bushing 38mm bracket width, Measure bar diameter 18,19 & 28.5mm available	MPU-2303-__K	1	Bushings	
TRAS.	Trailing Arm Upper Bushing All Upper A arm to chassis bush	MPU-0128K	1	Inner Tubes, Bushings	



## LEXUS ES300 Sedan - 4/1990 - 11/1994

Página 1









Aplicaci...	Descripción	Referencia	Kits por...	Contenido del Kit	
DEL.	Sway Bar Mount To Chassis Bushing Measure bar diameter 17,18,20,23mm available	<b>MPU-1132-__K</b>	1	Bushings	
DEL.	Control Arm Lower Rear Bushing PS & DS standard	<b>MPU-1265K</b>	1	Inner Tubes, Bushings	
DEL.	Control Arm Lower-Front Bushing Re-use original mounting pin	<b>MPU-2663K</b>	1	Bushings	
DEL.	Control Arm Lower-Inner Rear Eccentric Cast Arm, PS increased DS standard caster	<b>MPU-1266K</b>	1	Inner Tubes, Bushings	
DEL.	Control Arm Lower-Inner Rear Eccentric Cast Arm, PS increased DS decrease caster	<b>MPU-1267K</b>	1	Inner Tubes, Bushings	
DEL.	Engine Steady Bushing Large end has 50mm inside diameter	<b>MPU-1348K</b>	1	Bushings, Inner Tubes	
DEL.	Engine Steady Bushing Large end has 65mm inside diameter	<b>MPU-2706K</b>	1	Bushings, Inner Tubes	

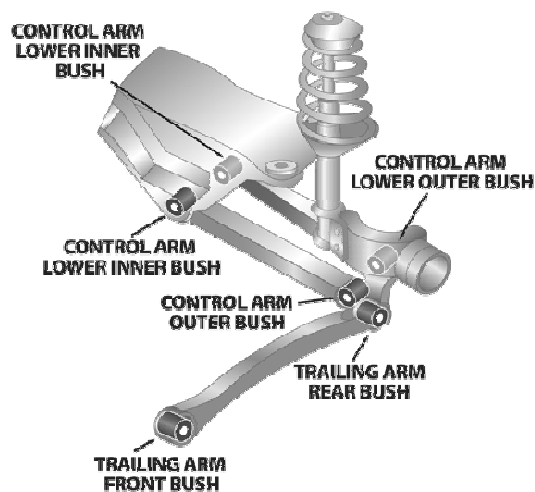
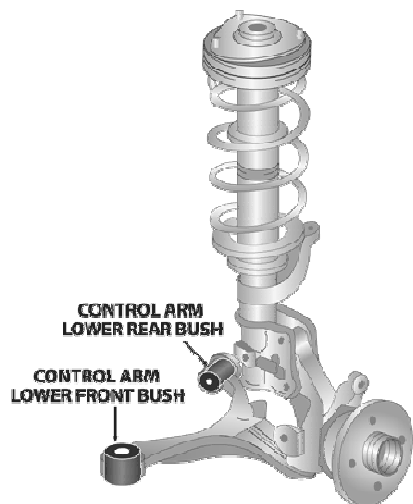

## LEXUS ES300 Sedan - 4/1990 - 11/1994

Página 2 (Continúa)



Aplicaci...	Descripción	Referencia	Kits por...	Contenido del Kit	
DEL.	Steering Rack & Pinion Mount Bush.....Power Steering Power steering	<b>MPU-1191K</b>	1	Inner Tubes, Bushings	
DEL.	Steering Rack & Pinion Mount Bush.....Power Steering Koyo Brand rack only	<b>MPU-3197K</b>	1	Inner Tubes, Bushings	
TRAS.	Control Arm-Outer Bushing Fits outer of both front & rear arms	<b>MPU-1105K</b>	1	Bushings, Inner Tubes	
TRAS.	Sway Bar Mount To Chassis Bushing Replaces OE # 48818-06051, 15 & 16mm available	<b>MPU-2297-__K</b>	1	Bushings	
TRAS.	Trailing Arm - Bushing Kit	<b>MPU-0823K</b>	1	Inner Tubes, Bushings	





## LEXUS SC300 / SC400 JZZ31 UZZ30 Coupe - 1990 - 2000

Página 1

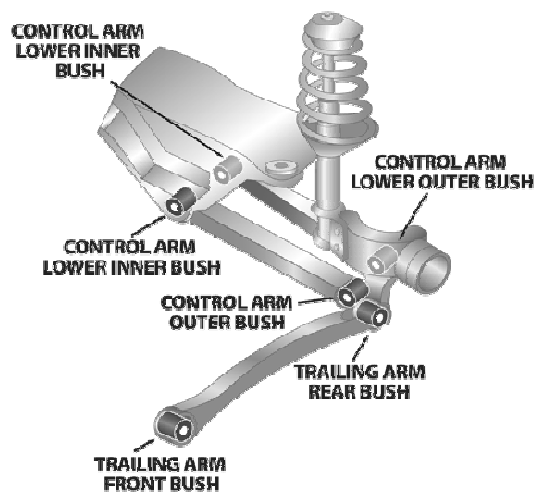
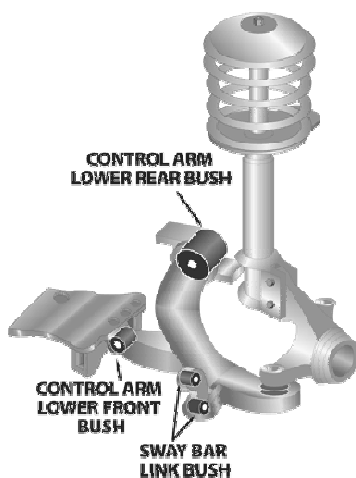

Aplicaci...	Descripción	Referencia	Kits por...	Contenido del Kit	
DEL.	Control Arm Lower Rear Bushing Early model, Bush OD = 54.8mm	<b>MPU-1404K</b>	1	Bushings, Inner Tubes	
DEL.	Control Arm Lower Rear Bushing Late model, bush OD = 51.1mm	<b>MPU-1651K</b>	1	Inner Tubes, Bushings	
DEL.	Control Arm Lower-Front Bushing Early model, Bush OD = 49.5mm	<b>MPU-1403K</b>	1	Inner Tubes, Bushings	
DEL.	Control Arm Lower-Front Bushing Late model, bush OD = 46mm	<b>MPU-1650K</b>	1	Inner Tubes, Bushings	
DEL.	Control Arm Upper-Inner Kit Measure housing, this kit suits 20mm wide	<b>MPU-1352K</b>	1	Bushings, Inner Tubes	
DEL.	Control Arm Upper-Inner Kit Measure housing, this kit suits 38mm wide	<b>MPU-1474K</b>	1	Inner Tubes, Bushings	
DEL.	Steering Rack & Pinion Mount Bushing Replaces OE#45517-24030,suited to vehicles with steering rack housing outside diameter...	<b>MPU-1193-50K</b>	1	Inner Tubes, Bushings	



## LEXUS SC300 / SC400 JZZ31 UZZ30 Coupe - 1990 - 2000

Página 2 (Continúa)

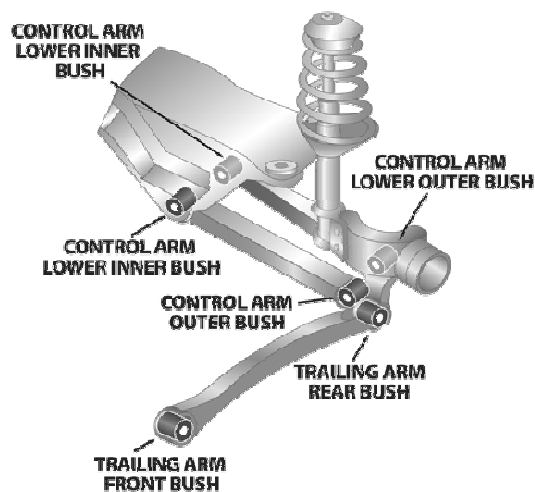
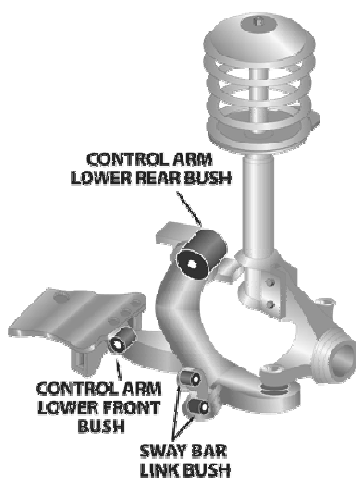





Aplicaci...	Descripción	Referencia	Kits por...	Contenido del Kit	
DEL.	Steering Rack & Pinion Mount Bushing Replaces OE#45517-14040,suited to vehicles with steering rack housing outside diameter...	<b>MPU-1193-47K</b>	1	Inner Tubes, Bushings	
DEL.	Sway Bar Mount To Chassis Bushing Suits bracket height of 42mm, Measure bar diameter 24,25,26,27,28,29,30,32mm available	<b>MPU-0342-__K</b>	1	Bushings	
DEL.	Sway Bar Mount To Chassis Bushing Suits bracket height of 49mm, Measure bar diameter 21,22,23,24,27,28,30,32mm available	<b>MPU-1846-__K</b>	1	Bushings	
TRAS.	Cross-member Supplement Washers Front mount	<b>MPU-2553K</b>	1	Bushings	
TRAS.	Control Arm Upper-Inner Kit Remove outer shells for fitment	<b>MPU-1922K</b>	1	Inner Tubes, Bushings	
TRAS.	Cross-member Supplement Washers Rear mount, to be fitted into original bushing	<b>MPU-2520K</b>	1	Washers, Bushings	
TRAS.	Differential Pinion Mount Bushing Upper is replacement bushing, lower is insert to original rubber bushing	<b>MPU-2769K</b>	1	Washers, Bushings	

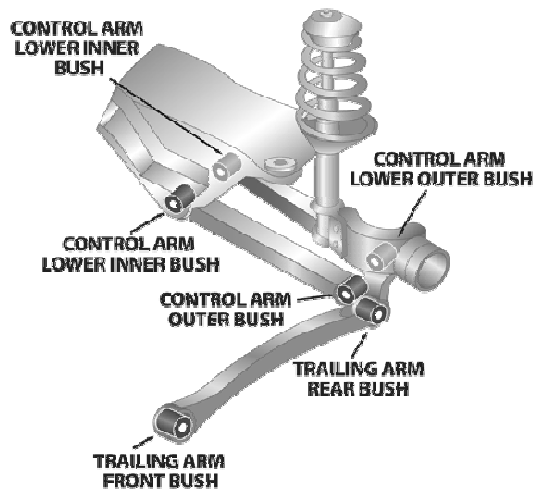
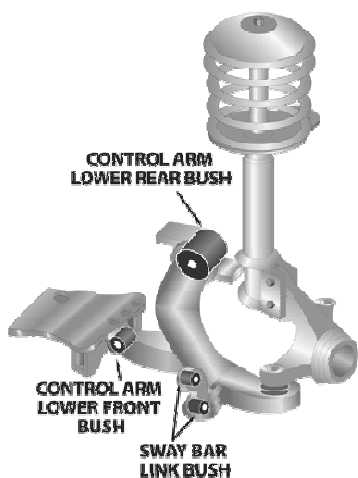

**LEXUS SC300 / SC400 JZZ31 UZZ30 Coupe - 1990 - 2000**

Página 3 (Continúa)

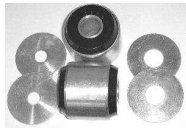

Aplicaci...	Descripción	Referencia	Kits por...	Contenido del Kit	
TRAS.	Sub Frame Rear Bushing Replaces original bushing	<b>MPU-3269K</b>	1	Washers, Outer Shells, Inner Tubes, Bushings	
TRAS.	Sway Bar Mount To Chassis Bushing Suits bracket height of 42mm, Measure bar diameter 24,25,26,27,28,29,30,32mm available	<b>MPU-0342-__K</b>	1	Bushings	



LEXUS LS400 Sedan UCF10 / UCF11 - 1989 - 1994

Página 1

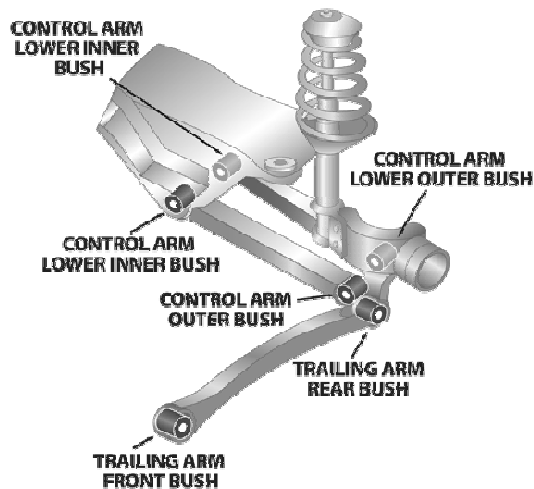
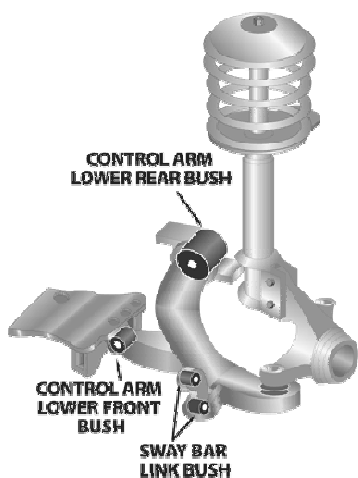

Aplicaci...	Descripción	Referencia	Kits por...	Contenido del Kit	
DEL.	Control Arm Lower-Inner Bushing	MPU-3090K	1	Inner Tubes, Bushings	
DEL.	Control Arm Upper-Inner Kit	MPU-1352K	1	Bushings, Inner Tubes	
DEL.	Steering Rack & Pinion Mount Bushing	MPU-3009K	1	Bushings	
DEL.	Strut Bar To Chassis Mount Kit	MPU-2989K	1	Plates, Washers, Inner Tubes, Bushings	
DEL.	Sway Bar Mount Bushing Measure bar diameter, 26.5mm available	MPU-3011-__K	1	Bushings	
TRAS.	Trailing Arm - Front Bushing	MPU-3016K	1	Inner Tubes, Bushings	
TRAS.	Control Arm Lower-Inner Bushing	MPU-3014K	1	Outer Shells, Inner Tubes, Bushings	



**LEXUS LS400 Sedan UCF10 / UCF11 - 1989 - 1994**

Página 2 (Continúa)

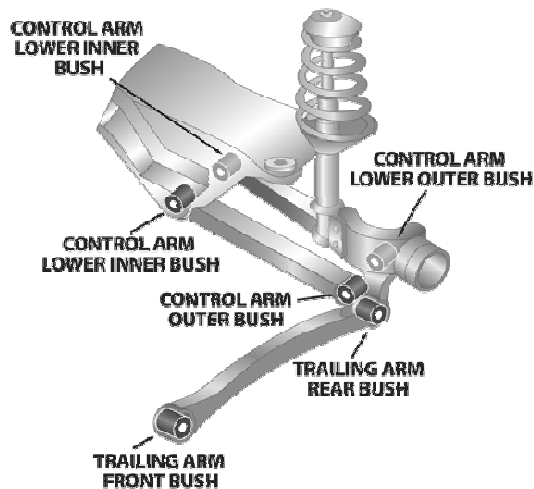
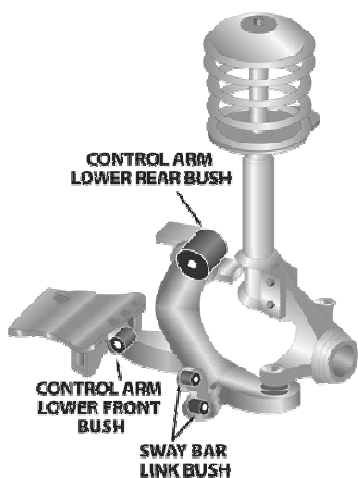



Aplicaci...	Descripción	Referencia	Kits por...	Contenido del Kit	
TRAS.	Control Arm Lower-Outer Bushing Bushing located in hub	<b>MPU-3015K</b>	1	Inner Tubes, Bushings	
TRAS.	Control Arm Upper-Inner Eccentric Kit Camber adjustment +/- both sides, gives aproximatley 3/4 degree change	<b>MPU-3013K</b>	1	Outer Shells, Inner Tubes, Bushings	
TRAS.	Control Arm Upper-Inner Kit Standard replacement	<b>MPU-3012K</b>	1	Outer Shells, Inner Tubes, Bushings	
TRAS.	Differential Pinion Mount Bushing Upper is replacement bushing, lower is insert to original rubber bushing	<b>MPU-2769K</b>	1	Washers, Bushings	
TRAS.	Sway Bar Mount Bushing Suits bracket height of 49mm, Measure bar diameter 21,22,23,24,27,28,30,32mm available	<b>MPU-1846-__K</b>	1	Bushings	
TRAS.	Toe Control Arm - Inner Bushing Outer end of arm is ball joint style bushing	<b>MPU-3017K</b>	1	Inner Tubes, Bushings	
TRAS.	Trailing Arm - Rear Bushing	<b>MPU-2249K</b>	1	Inner Tubes, Bushings	

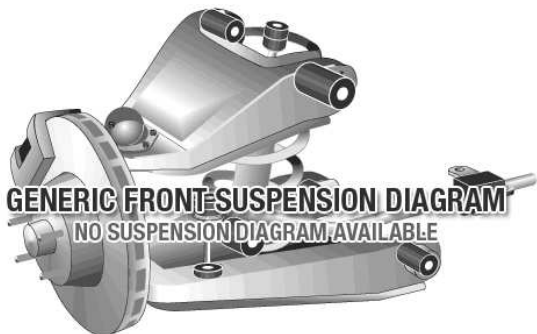

**LEXUS LS400 UCF20 (XF20) - 1994 - 2000**

Página 1



Aplicaci...	Descripción	Referencia	Kits por...	Contenido del Kit	
DEL.	Control Arm Lower-Inner Bushing	<b>MPU-3090K</b>	1	Inner Tubes, Bushings	



**LEXUS LX470 4WD Wagon - 5/1998 - 2004**

Página 1

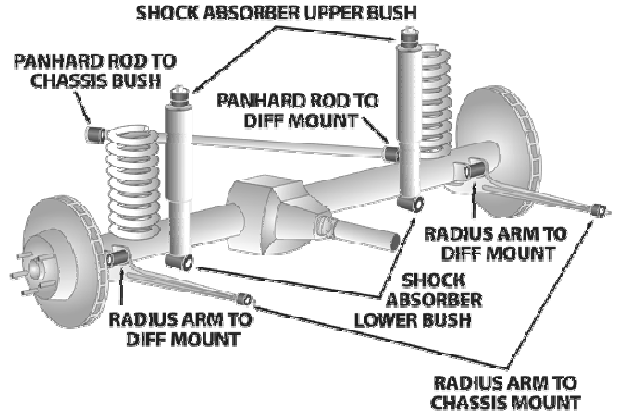
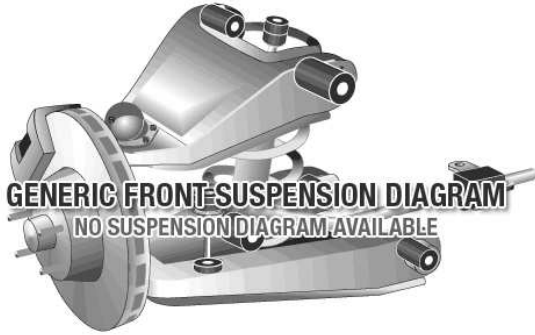







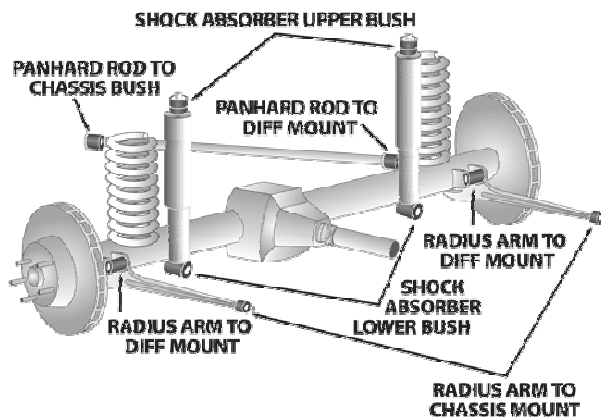
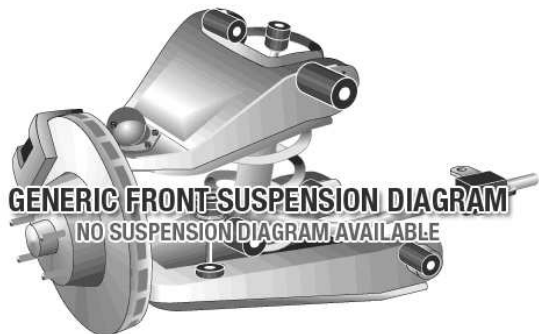

Aplicaci...	Descripción	Referencia	Kits por...	Contenido del Kit	
DEL.	Control Arm Lower-Inner Front Kit Bush located in control arm, replaces original part number 48654-60010	<b>MPU-2143K</b>	1	Inner Tubes, Bushings	
DEL.	Control Arm Upper-Inner Kit Replaces original poart number 48632-60010	<b>MPU-2142K</b>	1	Washers, Outer Shells, Inner Tubes, Bushings	
DEL.	Shock Absorber Lower Bushing Original shocks only, Replaces 90903-89016	<b>MPU-1575K</b>	1	Bushings, Inner Tubes	
DEL.	Shock Absorber Upper Bushing Original shocks only, Replaces 90540-17006	<b>MPU-2350K</b>	1	Bushings	
DEL.	Steering Rack & Pinion Mount Bushing LHS & RHS, Only fits vehicles up to 08/2002	<b>MPU-2470K</b>	1	Inner Tubes, Bushings	
DEL.	Sway Bar End Link Bushing	<b>MPU-2755SK</b>	1	Bushings	
DEL.	Sway Bar Link Lower Bushing	<b>MPU-2147K</b>	1	Inner Tubes, Bushings	



LEXUS LX470 4WD Wagon - 5/1998 - 2004

Página 2 (Continúa)



Aplicaci...	Descripción	Referencia	Kits por...	Contenido del Kit	
DEL.	Sway Bar Mount To Chassis Bushing Measure bar diameter 20,22,23,24,25,26,27,28,29,30,31,32,34mm...	MPU-1155-__K	1	Bushings	
TRAS.	Trailing Arm Upper Bushing All 14mm Bolt	MPU-2461K	2	Inner Tubes, Bushings	
TRAS.	Coil Spring Spacer Bushing Raises vehicle approximately 10mm	MPU-1724-10K	2	Bushings	
TRAS.	Coil Spring Spacer Bushing Raises vehicle approximately 15mm	MPU-1724-15K	2	Bushings	
TRAS.	Coil Spring Spacer Bushing Raises vehicle approximately 30mm	MPU-1724-30K	2	Bushings	
TRAS.	Coil Spring Spacer Bushing Raises vehicle approximately 20mm	MPU-1724-20K	2	Bushings	
TRAS.	Panhard Rod Bushing 14mm Bolt	MPU-2464K	1	Bushings, Inner Tubes	









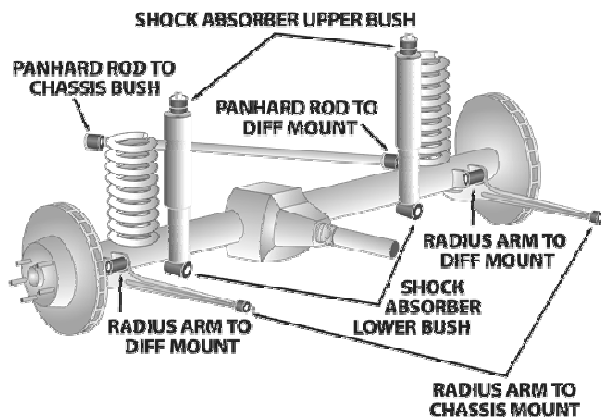
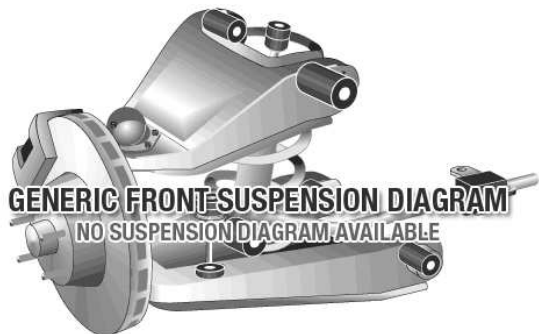

LEXUS LX470 4WD Wagon - 5/1998 - 2004

Página 3 (Continúa)



Aplicaci...	Descripción	Referencia	Kits por...	Contenido del Kit	
TRAS.	Shock Absorber Lower Bushing Original shocks only, Replaces 90385-19010	<b>MPU-2352K</b>	1	Bushings, Inner Tubes	
TRAS.	Shock Absorber Upper Bushing Original shocks only, Replaces 90948-01064	<b>MPU-2351K</b>	1	Bushings	
TRAS.	Sway Bar End Link Bushing	<b>MPU-0280K</b>	1	Inner Tubes, Bushings	
TRAS.	Sway Bar Mount To Chassis Bushing Measure bar diameter	<b>MPU-1319-__K</b>	1	Bushings	
TRAS.	Trailing Arm Lower Bushing All 14mm Bolt	<b>MPU-2460K</b>	2	Bushings, Inner Tubes	
TRAS.	Trailing Arm & Panhard Rod Kit Rear kit, SPF2464 x 1, SPF2460K x 2, SPF2461K x 2	<b>MPK-097K</b>	1	Bushings, Inner Tubes	



## LEXUS IS200 GXE10 - 01/1999 - 2005

Página 1

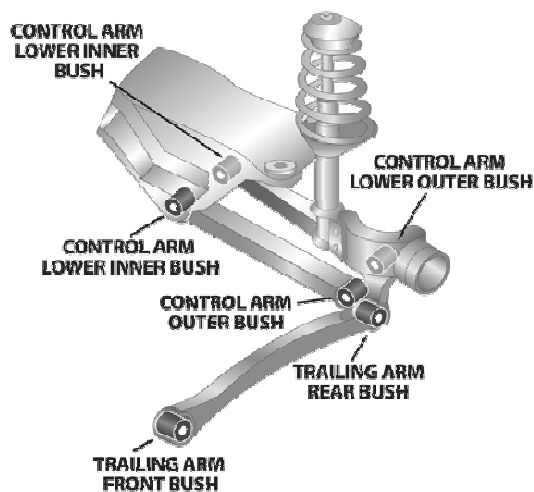
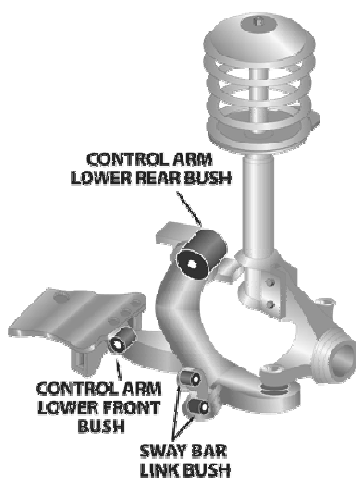







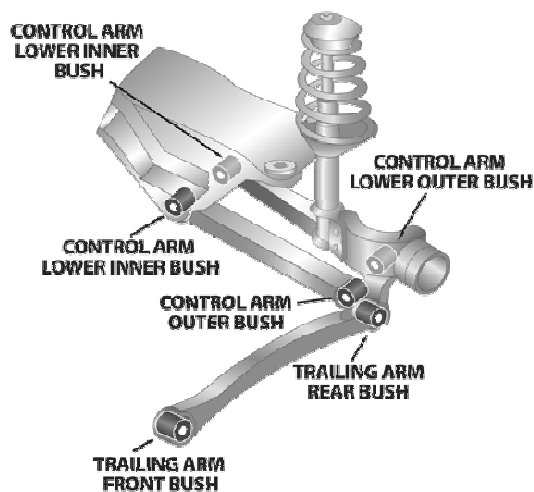
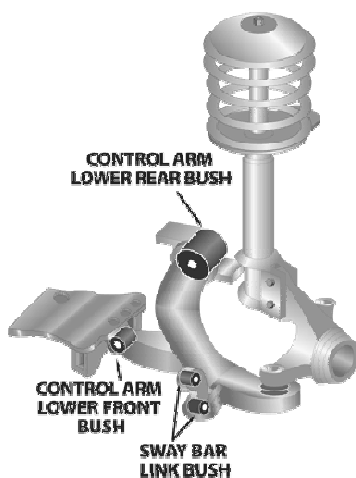

Aplicaci...	Descripción	Referencia	Kits por...	Contenido del Kit	
DEL.	Control Arm Lower Rear Bushing Standard replacement.	<b>MPU-3040K</b>	1	Outer Shells, Inner Tubes, Bushings	
DEL.	Control Arm Lower Rear Bushing (Eccentric) 1 x standard & 1 x offset bushing, Castor adjustment	<b>MPU-3041K</b>	1	Outer Shells, Inner Tubes, Bushings	
DEL.	Control Arm Lower Rear Bushing (Eccentric) 2 x offset bushings for castor adjustment.	<b>MPU-3042K</b>	1	Outer Shells, Inner Tubes, Bushings	
DEL.	Control Arm Lower-Inner Bushing	<b>MPU-3039K</b>	1	Inner Tubes, Bushings	
DEL.	Sway Bar Mount Bushing Replaces OE# 48815-53010 = 27mm; Measure bar diameter	<b>MPU-2816-__K</b>	1	Bushings	
TRAS.	Sway Bar Mount Bushing Replaces OE# 48818-30010 = 14mm. Please measure bar diameter on vehicle as 15,17,18 & 19mm also available.	<b>MPU-2817-__K</b>	1	Bushings	
TRAS.	Control Arm Lower-Inner Bushing Standard replacement	<b>MPU-3036K</b>	1	Outer Shells, Inner Tubes, Bushings	



LEXUS IS200 GXE10 - 01/1999 - 2005

Página 2 (Continúa)









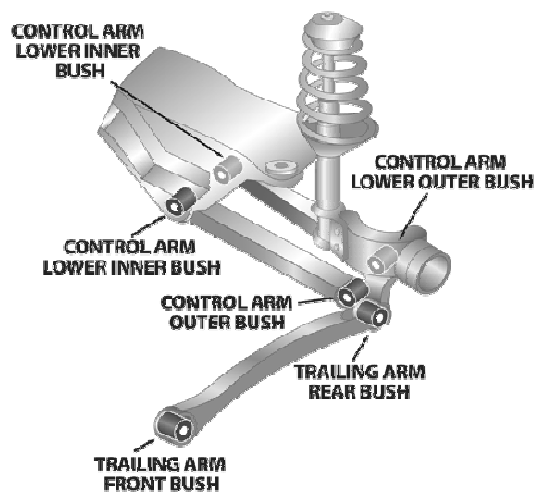
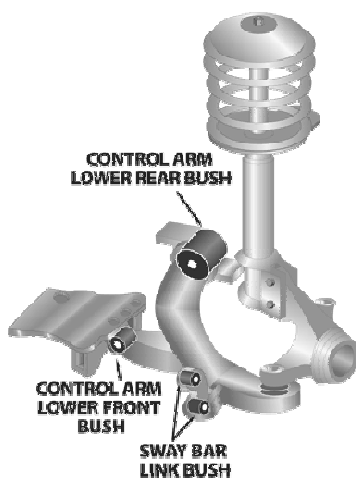

Aplicaci...	Descripción	Referencia	Kits por...	Contenido del Kit	
TRAS.	Control Arm Lower-Inner Eccentric Kit Camber +/- adjustment both sides, approximately 0.6 degree camber change	<b>MPU-3037K</b>	1	Outer Shells, Inner Tubes, Bushings	
TRAS.	Control Arm Upper-Inner Eccentric Kit Camber adjustment +/- both sides, approximately 0.6 degree camber change	<b>MPU-3044K</b>	1	Inner Tubes, Bushings	
TRAS.	Control Arm Upper-Inner Kit Standard replacement	<b>MPU-3043K</b>	1	Inner Tubes, Bushings	
TRAS.	Toe Control Arm - Inner Bushing Note	<b>MPU-2786K</b>	1	Inner Tubes, Bushings	
TRAS.	Trailing Arm - Front Bushing	<b>MPU-2784K</b>	1	Inner Tubes, Bushings	
TRAS.	Trailing Arm - Rear Bushing Bushing located in hub	<b>MPU-2785K</b>	1	Inner Tubes, Bushings	



## LEXUS IS300 JCE10 -

Página 1









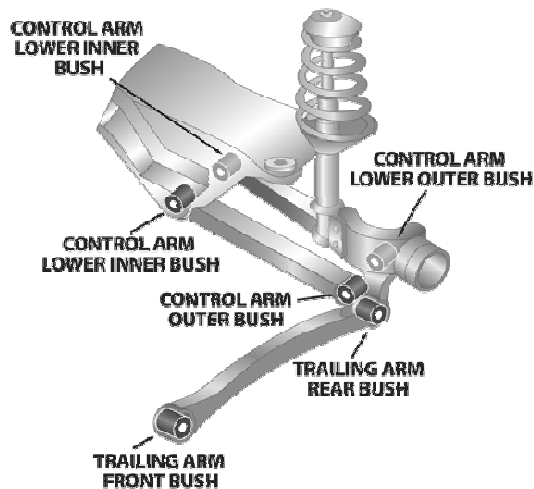
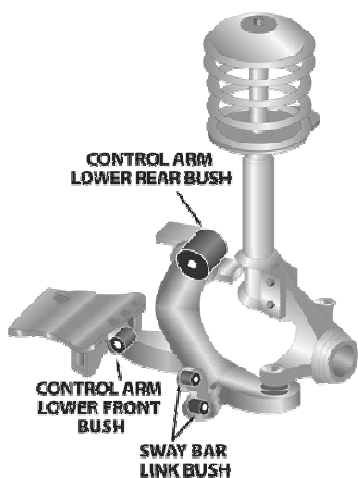

Aplicaci...	Descripción	Referencia	Kits por...	Contenido del Kit	
DEL.	Control Arm Lower Rear Bushing (Eccentric) Double Offset.	<b>MPU-3692-90K</b>	1	Inst Sheet, Outer Shells, Inner Tubes, Bushings	
DEL.	Control Arm Lower Rear Bushing Single Offset.	<b>MPU-3675K</b>	1	Outer Shells, Inner Tubes, Bushings	
DEL.	Control Arm Lower Rear Bushing Double Offset.	<b>MPU-3692K</b>	1	Outer Shells, Inner Tubes, Bushings	
DEL.	Control Arm Lower Rear Bushing Standard.	<b>MPU-3491K</b>	1	Outer Shells, Inner Tubes, Bushings	
DEL.	Control Arm Lower Rear Bushing H/DUTY KIT FOR TRACK USE ONLY	<b>MPU-3491-90K</b>	1	Outer Shells, Inner Tubes, Bushings	
DEL.	Control Arm Upper-Inner Bushing	<b>MPU-3507K</b>	1	Outer Shells, Inner Tubes, Bushings	
DEL.	Sway Bar Mount Bushing Replaces OE# 48815-53010 = 27mm; Measure bar diameter	<b>MPU-2816-__K</b>	1	Bushings	



## LEXUS IS300 JCE10 -

Página 2 (Continúa)







Aplicaci...	Descripción	Referencia	Kits por...	Contenido del Kit	
DEL.	Sway Bar Mount To Chassis Bushing Available in sizes - 24, 27, 28, 30, & 32.5mm.	<b>MPU-3584-__K</b>	1	Bushings	
TRAS.	Control Arm Lower-Inner Bushing	<b>MPU-3508K</b>	1	Outer Shells, Inner Tubes, Bushings	
TRAS.	Sway Bar Mount Bushing Replaces OE# 48818-30010 = 14mm. Please measure bar diameter on vehicle as 15,17,18 & 19mm also available.	<b>MPU-2817-__K</b>	1	Bushings	
TRAS.	Sway Bar Mount To Chassis Bushing Available in sizes - 14, 15, 17, 18 & 19mm.	<b>MPU-3494-__K</b>	1	Bushings	
TRAS.	Trailing Arm Lower Front Bushing	<b>MPU-3503K</b>	1	Inner Tubes, Bushings	
TRAS.	Trailing Arm Upper Front Bushing	<b>MPU-3504K</b>	1	Inner Tubes, Bushings	
TRAS.	Trailing Arm Upper Rear Bushing	<b>MPU-3501K</b>	1	Inner Tubes, Bushings	

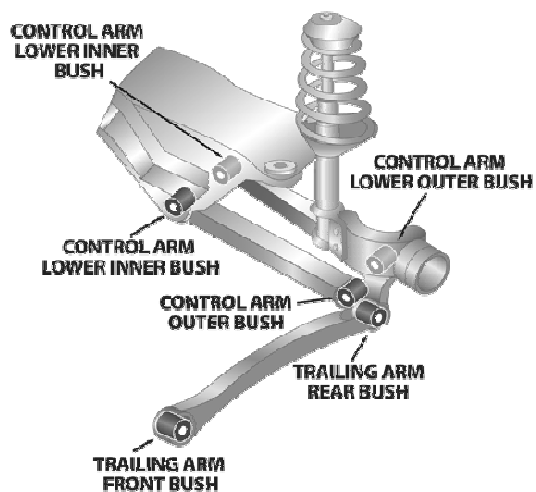
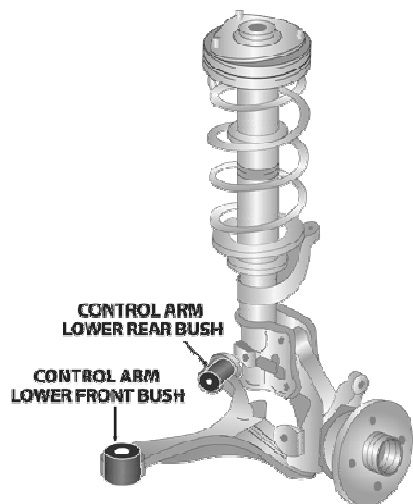

LEXUS GS300 / 400 / 430 JZS160, UZS160 - 1997 - 8/1999

Página 1



Aplicaci...	Descripción	Referencia	Kits por...	Contenido del Kit	
TRAS.	Differential Pinion, Mount Bushing Upper is replacement bushing, lower is insert to original rubber bushing	MPU-2769K	1	Washers, Bushings	
TRAS.	Sway Bar Mount Bushing Replaces OE# 48818-30010 = 14mm. Please measure bar diameter on vehicle as 15,17,18 & 19mm also available.	MPU-2817-__K	1	Bushings	

LEXUS GS300 / 400 / 430 JZS147 - 1991 - 1996

Página 1

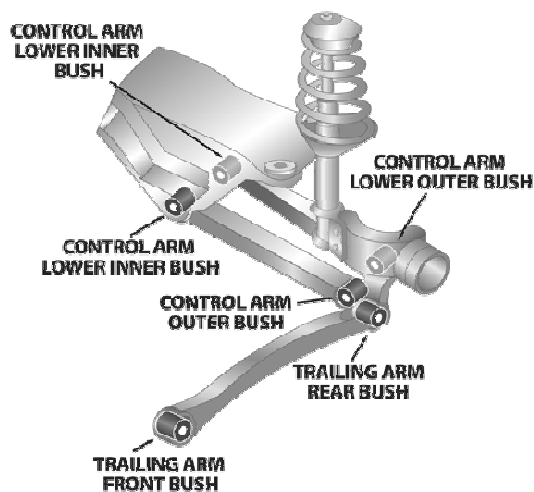
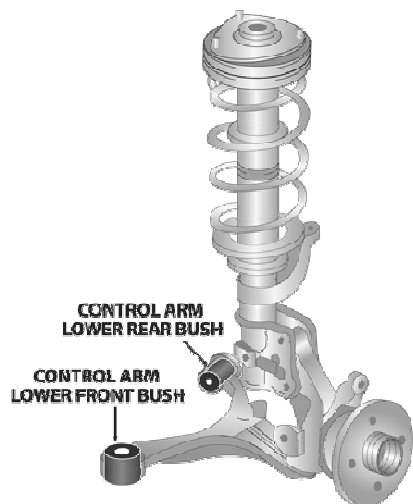







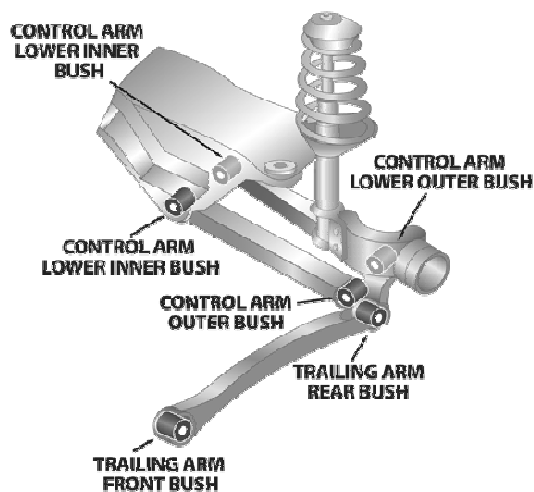
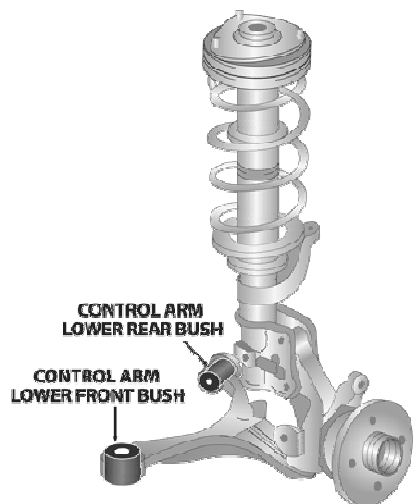

Aplicaci...	Descripción	Referencia	Kits por...	Contenido del Kit	
DEL.	Control Arm Lower-Inner Bushing Standard replacement kit	<b>MPU-3162K</b>	1	Inner Tubes, Bushings	
DEL.	Control Arm Lower-Inner Eccentric Kit Offset tube Camber adjust +/-	<b>MPU-3163K</b>	1	Inner Tubes, Bushings	
DEL.	Control Arm Upper-Inner Kit Replaces OE# 48632-30090	<b>MPU-3161K</b>	1	Inner Tubes, Bushings	
DEL.	Strut Bar To Chassis Mount Kit Standard bush kit, Replaces OE#4865-30020	<b>MPU-3087K</b>	1	Outer Shells, Inner Tubes, Bushings	
DEL.	Strut Bar To Chassis Mount-Adjustable Bushing 1 x Standard & 1 x Offset bushing, Replaces OE#4865-30020	<b>MPU-3088K</b>	1	Outer Shells, Inner Tubes, Bushings	
DEL.	Sway Bar Mount Bushing Replaces OE#48815-90370 @ 30mm; Please measure bar diameter on vehicle	<b>MPU-3164-__K</b>	1	Bushings	
TRAS.	Control Arm Lower-Inner Bushing	<b>MPU-3032K</b>	1	Inner Tubes, Bushings	

## LEXUS GS300 / 400 / 430 JZS147 - 1991 - 1996

Página 2 (Continúa)







Aplicaci...	Descripción	Referencia	Kits por...	Contenido del Kit	
TRAS.	Control Arm Lower-Shock Mount Kit	<b>MPU-3033K</b>	1	Inner Tubes, Bushings	
TRAS.	Control Arm Upper-Inner Kit Remove outer shells for fitment	<b>MPU-1922K</b>	1	Inner Tubes, Bushings	
TRAS.	Cross-member Supplement Washers Rear mount, to be fitted into original bushing	<b>MPU-2520K</b>	1	Washers, Bushings	
TRAS.	Differential Pinion, Mount Bushing Upper is replacement bushing, lower is insert to original rubber bushing	<b>MPU-2769K</b>	1	Washers, Bushings	
TRAS.	Sub Frame Rear Bushing Replaces original bushing	<b>MPU-3269K</b>	1	Washers, Outer Shells, Inner Tubes, Bushings	
TRAS.	Sway Bar Mount Bushing Replaces OE# 48818-30080 @ 24mm; Please measure bar diameter on vehicle	<b>MPU-3165-__K</b>	1	Bushings	
TRAS.	Toe Control Arm - Inner Bushing Outer end of arm is ball joint style bushing	<b>MPU-3017K</b>	1	Inner Tubes, Bushings	

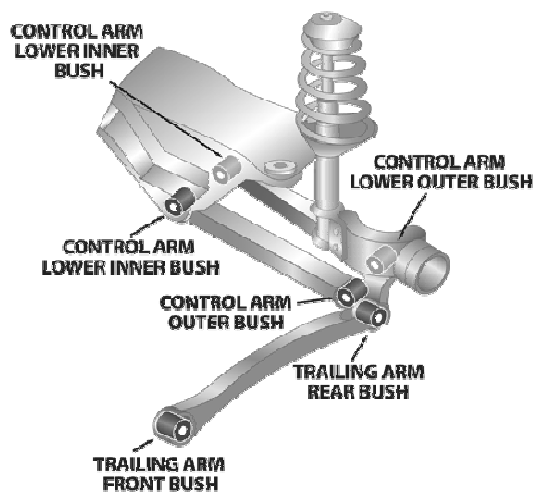
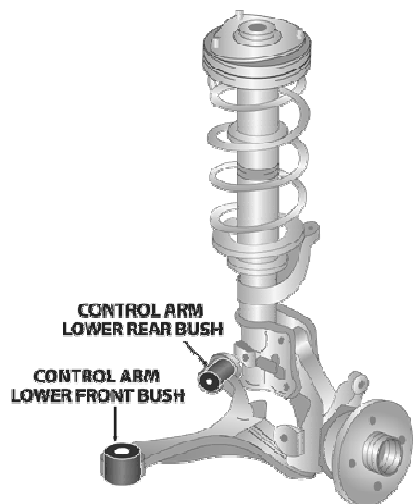

**LEXUS GS300 / 400 / 430 JZS147 - 1991 - 1996**

Página 3 (Continúa)



Aplicaci...	Descripción	Referencia	Kits por...	Contenido del Kit	
TRAS.	Trailing Arm - Front Bushing	<b>MPU-3016K</b>	1	Inner Tubes, Bushings	
TRAS.	Trailing Arm - Rear Bushing Bushing located in hub	<b>MPU-3031K</b>	1	Inner Tubes, Bushings	

**LEXUS LS430 UCF30 - 2001 - On**

Página 1

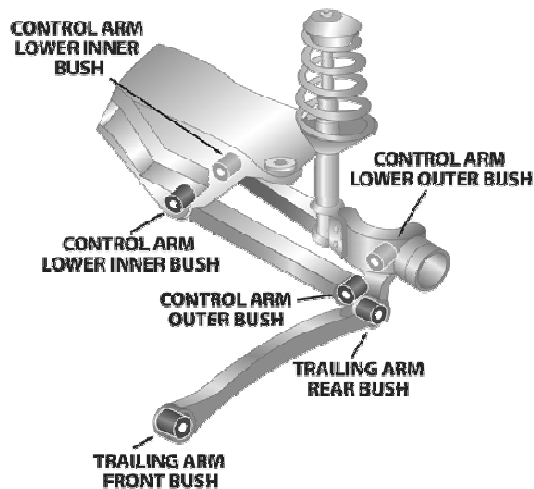
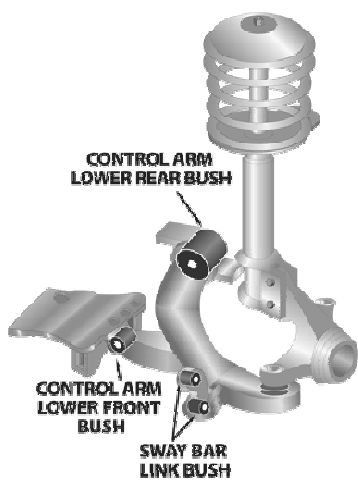

Aplicaci...	Descripción	Referencia	Kits por...	Contenido del Kit	
TRAS.	Differential Pinion Mount Bushing Upper is replacement bushing, lower is insert to original rubber bushing	<b>MPU-2769K</b>	1	Washers, Bushings	

## LEXUS GX470 SUV Wagon - 2003 - 2008

Página 1

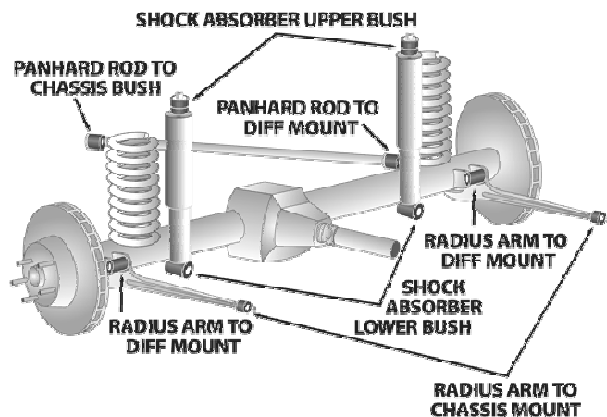
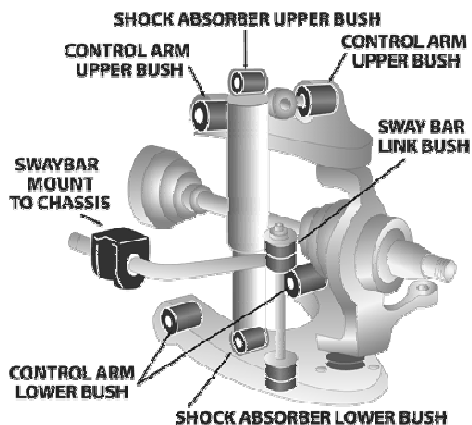



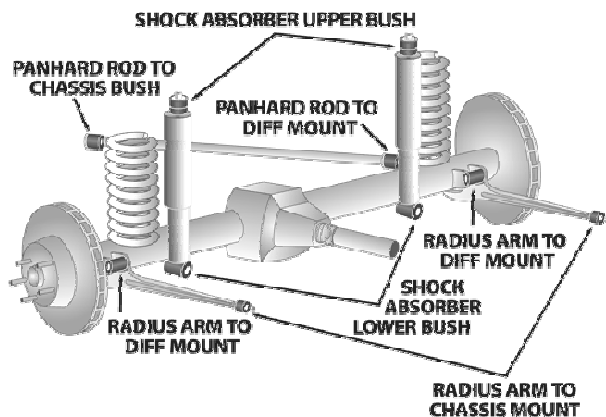
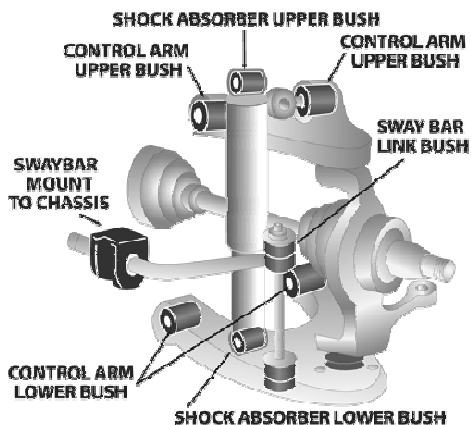

Aplicaci...	Descripción	Referencia	Kits por...	Contenido del Kit	
DEL.	Control Arm Lower-Inner Front & Rear CONTENTS - SPF2834K x 1, SPF2835K x 1	<b>MPK-180K</b>	1	Washers, Outer Shells, Inner Tubes, Bushings	
DEL.	Control Arm Lower-Inner Front Kit Replaces original shell part	<b>MPU-2834K</b>	1	Washers, Outer Shells, Inner Tubes, Bushings	
DEL.	Control Arm Lower-Inner Rear Kit Standard replacement	<b>MPU-2835K</b>	1	Washers, Outer Shells, Inner Tubes, Bushings	
DEL.	Control Arm Upper-Inner Eccentric Kit Offset tube in kit for Camber Decrease on raised vehicles, Remove original shell for fitment	<b>MPU-3230K</b>	1	Inst Sheet, Washers, Inner Tubes, Bushings	
DEL.	Control Arm Upper-Inner Kit Standard replacement, Remove original shell for fitment	<b>MPU-2845K</b>	1	Washers, Inner Tubes, Bushings	
DEL.	Shock Absorber Lower Bushing	<b>MPU-3591K</b>	1	Outer Shells, Inner Tubes, Bushings	
DEL.	Sway Bar Mount Bushing Measure bar diameter, 19, 29mm available	<b>MPU-2506-__K</b>	1	Bushings	

## LEXUS GX470 SUV Wagon - 2003 - 2008

Página 2 (Continúa)







Aplicaci...	Descripción	Referencia	Kits por...	Contenido del Kit	
TRAS.	Panhard Rod Bushing Replaces both ends of the bar	<b>MPU-2836K</b>	1	Inner Tubes, Bushings	
TRAS.	Sway Bar Mount Bushing Measure bar diameter, 15,16,17,18,19,20,21,22,23,24,25 & 27mm	<b>MPU-1487-__K</b>	1	Bushings	
TRAS.	Trailing Arm Lower Bushing All	<b>MPU-2461K</b>	2	Inner Tubes, Bushings	
TRAS.	Trailing Arm Upper Bushing All Replaces both ends of the bar	<b>MPU-1760K</b>	2	Inner Tubes, Bushings	

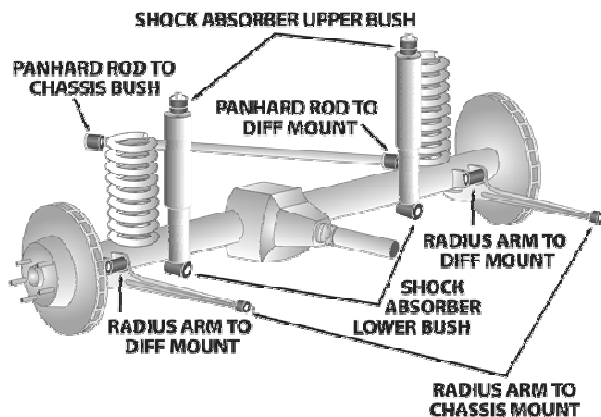
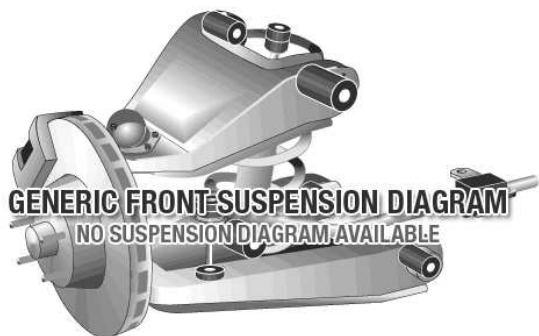

**LEXUS LX570 URJ200 4x4 Wagon -**

Página 1









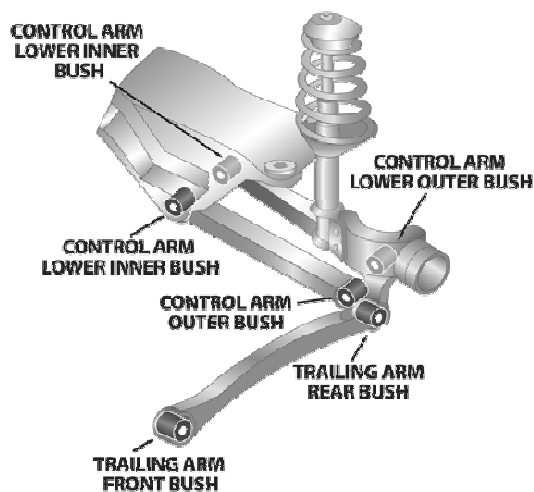
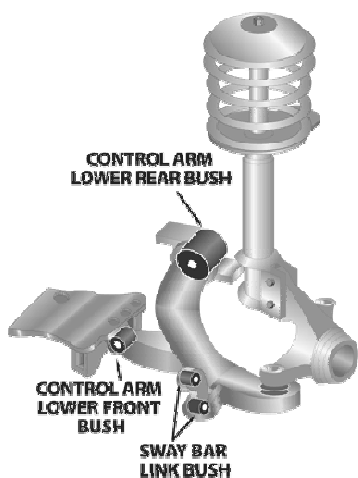

Aplicaci...	Descripción	Referencia	Kits por...	Contenido del Kit	
DEL.	Sway Bar Mount Bushing Non KDS Vehicle, suits OE bracket# 48824-60170, 32, 35, 37.5, 39 & 40mm available.	<b>MPU-3448-__K</b>	1	Bushings	
TRAS.	Sway Bar Mount Bushing Non KDS Vehicle, Suits OE bracket #48824-26230, 30,33,34mm available.	<b>MPU-3449-__K</b>	1	Bushings	



## LEXUS IS250 / IS350 GSE20 / GSE25 - 2005 - On

Página 1









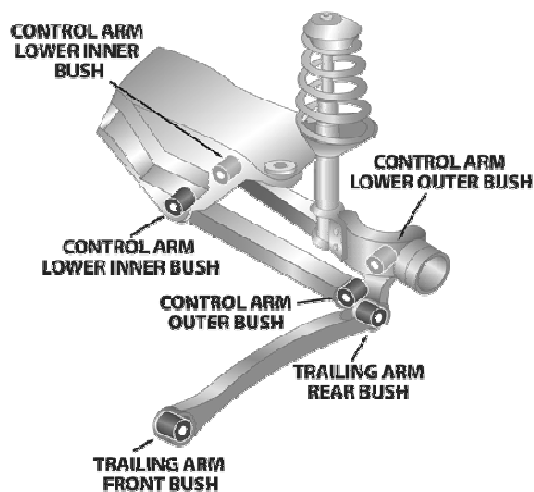
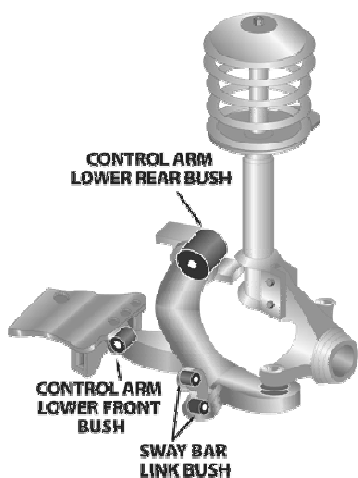

Aplicaci...	Descripción	Referencia	Kits por...	Contenido del Kit	
DEL.	Control Arm Lower Rear Bushing Standard.	<b>MPU-3491K</b>	1	Outer Shells, Inner Tubes, Bushings	
DEL.	Control Arm Lower Rear Bushing Single Offset.	<b>MPU-3675K</b>	1	Outer Shells, Inner Tubes, Bushings	
DEL.	Control Arm Lower Rear Bushing Double Offset.	<b>MPU-3692K</b>	1	Outer Shells, Inner Tubes, Bushings	
DEL.	Control Arm Lower Rear Bushing H/DUTY KIT FOR TRACK USE ONLY	<b>MPU-3491-90K</b>	1	Outer Shells, Inner Tubes, Bushings	
DEL.	Control Arm Lower Rear Bushing (Eccentric) Double Offset.	<b>MPU-3692-90K</b>	1	Inst Sheet, Outer Shells, Inner Tubes, Bushings	
DEL.	Control Arm Upper-Inner Bushing	<b>MPU-3507K</b>	1	Outer Shells, Inner Tubes, Bushings	
DEL.	Sway Bar Mount To Chassis Bushing Available in sizes - 24, 27, 28, 30 & 32.5mm.	<b>MPU-3584-__K</b>	1	Bushings	



**LEXUS IS250 / IS350 GSE20 / GSE25 - 2005 - On**

Página 2 (Continúa)







Aplicaci...	Descripción	Referencia	Kits por...	Contenido del Kit	
TRAS.	Control Arm Lower-Inner Bushing	<b>MPU-3508K</b>	1	Outer Shells, Inner Tubes, Bushings	
TRAS.	Sway Bar Mount To Chassis Bushing Available in sizes - 14, 15, 17, 18 & 19mm.	<b>MPU-3494-__K</b>	1	Bushings	
TRAS.	Toe Control Arm - Inner Bushing	<b>MPU-3506K</b>	1	Inner Tubes, Bushings	
TRAS.	Toe Control Arm - Inner Bushing	<b>MPU-3506K</b>	1	Inner Tubes, Bushings	
TRAS.	Trailing Arm Lower Front Bushing	<b>MPU-3503K</b>	1	Inner Tubes, Bushings	
TRAS.	Trailing Arm Upper Front Bushing	<b>MPU-3504K</b>	1	Inner Tubes, Bushings	
TRAS.	Trailing Arm Upper Rear Bushing	<b>MPU-3501K</b>	1	Inner Tubes, Bushings	

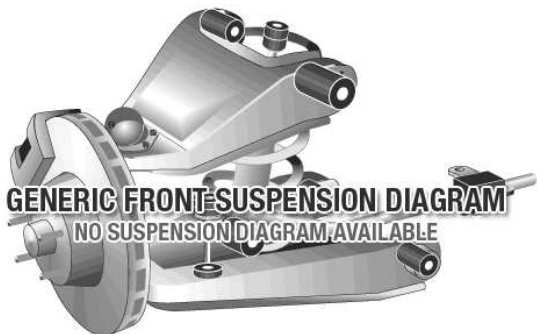

**LEXUS 200H CT (ZWA10) 3/2011 - Current -**

Página 1



Aplicaci...	Descripción	Referencia	Kits por...	Contenido del Kit	
DEL.	Sway Bar Mount To Chassis Bushing Available sizes - 22.2, 23.4,24,25.4mm	<b>MPU-3719-__K</b>	1	Bushings	
TRAS.	Sway Bar Mount To Chassis Bushing Available sizes	<b>MPU-3864-__K</b>	1	Bushings	





## LEXUS RX330 MCU - 2003 - 2006

Página 1

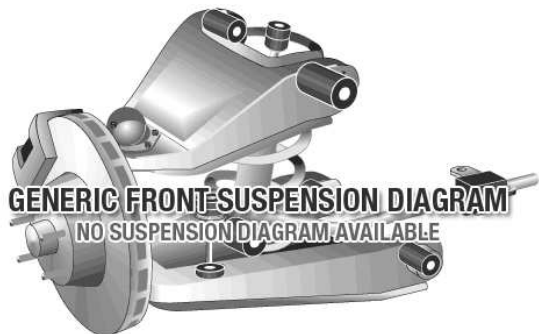

Aplicaci...	Descripción	Referencia	Kits por...	Contenido del Kit	
DEL.	Control Arm Lower-Inner Rear Kit Standard replacement kit.	<b>MPU-2902K</b>	1	Outer Shells, Inner Tubes, Bushings	
DEL.	Control Arm Lower-Inner Rear Kit 1 x Standard bushing & 1 x Offset bushing kit.	<b>MPU-2903K</b>	1	Outer Shells, Inner Tubes, Bushings	
DEL.	Control Arm Lower-Inner Rear Kit 2 x Offset bushing kit.	<b>MPU-2904K</b>	1	Outer Shells, Inner Tubes, Bushings	



**LEXUS RX350 GSU & GGL - 2006 - Current**

Página 1

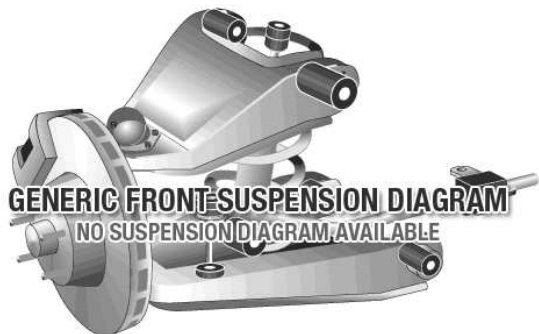



Aplicaci...	Descripción	Referencia	Kits por...	Contenido del Kit	
DEL.	Control Arm Lower-Inner Rear Kit Standard replacement kit.	<b>MPU-2902K</b>	1	Outer Shells, Inner Tubes, Bushings	
DEL.	Control Arm Lower-Inner Rear Kit 1 x Standard bushing & 1 x Offset bushing kit.	<b>MPU-2903K</b>	1	Outer Shells, Inner Tubes, Bushings	
DEL.	Control Arm Lower-Inner Rear Kit 2 x Offset bushing kit.	<b>MPU-2904K</b>	1	Outer Shells, Inner Tubes, Bushings	

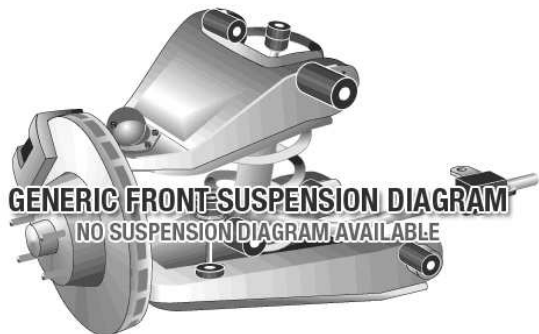

## LEXUS RX400H GSU - 2006 - 2009

Página 1



Aplicaci...	Descripción	Referencia	Kits por...	Contenido del Kit	
DEL.	Control Arm Lower-Inner Rear Kit Standard replacement kit.	<b>MPU-2902K</b>	1	Outer Shells, Inner Tubes, Bushings	 SPF2902K
DEL.	Control Arm Lower-Inner Rear Kit 1 x Standard bushing & 1 x Offset bushing kit.	<b>MPU-2903K</b>	1	Outer Shells, Inner Tubes, Bushings	
DEL.	Control Arm Lower-Inner Rear Kit 2 x Offset bushing kit.	<b>MPU-2904K</b>	1	Outer Shells, Inner Tubes, Bushings	



## LEXUS RX450H GGL - 2009 - Current

Página 1

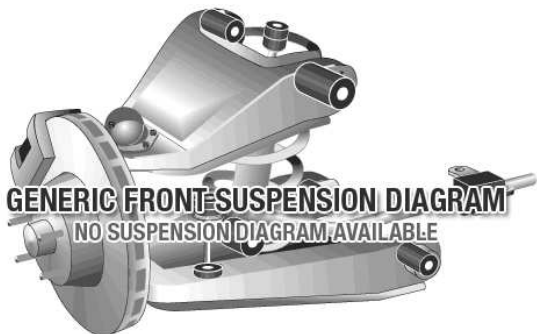



Aplicaci...	Descripción	Referencia	Kits por...	Contenido del Kit	
DEL.	Control Arm Lower-Inner Rear Kit Standard replacement kit.	<b>MPU-2902K</b>	1	Outer Shells, Inner Tubes, Bushings	
DEL.	Control Arm Lower-Inner Rear Kit 1 x Standard bushing & 1 x Offset bushing kit.	<b>MPU-2903K</b>	1	Outer Shells, Inner Tubes, Bushings	
DEL.	Control Arm Lower-Inner Rear Kit 2 x Offset bushing kit.	<b>MPU-2904K</b>	1	Outer Shells, Inner Tubes, Bushings	

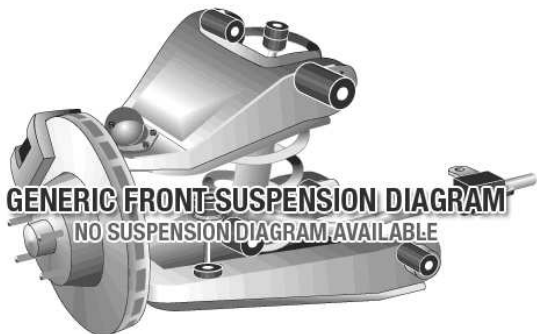

**LEXUS IS XE20 - 2006 - Current**

Página 1





Aplicaci...	Descripción	Referencia	Kits por...	Contenido del Kit	
DEL.	Control Arm Upper-Inner Eccentric Kit Offset.	<b>MPU-3507XK</b>	1	Inst Sheet, Outer Shells, Inner Tubes, Bushings	

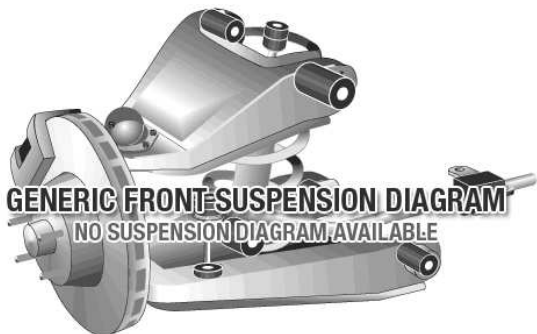

**LEXUS GS S190 - 2005 - Current**

Página 1





Aplicaci...	Descripción	Referencia	Kits por...	Contenido del Kit	
DEL.	Control Arm Upper-Inner Eccentric Kit Offset.	<b>MPU-3507XK</b>	1	Inst Sheet, Outer Shells, Inner Tubes, Bushings	

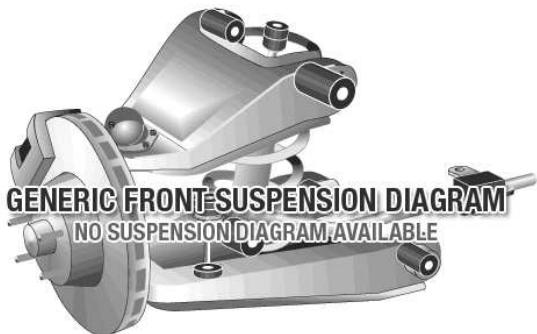

**LEXUS HS 250H - 2009 - Current**

Página 1









Aplicaci...	Descripción	Referencia	Kits por...	Contenido del Kit	
TRAS.	Sway Bar Mount To Chassis Bushing Available sizes	<b>MPU-3864-__K</b>	1	Bushings	

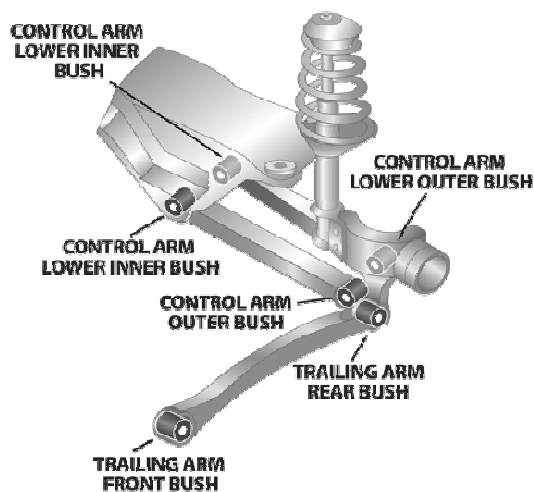
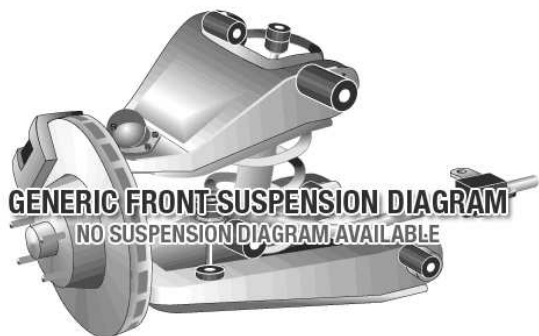

**MAZDA 121 DA1031 & DA1032 - 3/1987 - 12/1990**

Página 1



Aplicaci...	Descripción	Referencia	Kits por...	Contenido del Kit	
DEL.	Sway Bar Mount To Chassis Bushing Measure bar diameter 22,24,26mm available	<b>MPU-1478-__K</b>	1	Bushings	
DEL.	Sway Bar To Lower Control Arm Kit Measure bush, 25mm length & flange diameter 47mm	<b>MPU-0161K</b>	1	Bushings	 0161K
DEL.	Sway Bar To Lower Control Arm Kit Measure bush, 20mm length & flange diameter 36mm	<b>MPU-1477K</b>	1	Bushings	 1477K
DEL.	Control Arm Lower-Inner Bushing	<b>MPU-1318K</b>	1	Bushings, Inner Tubes	 1318K







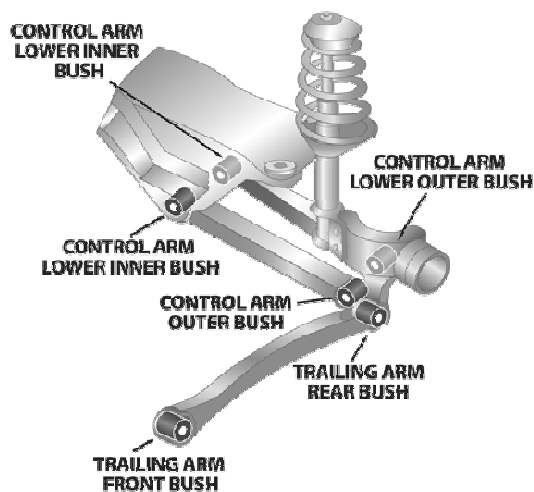
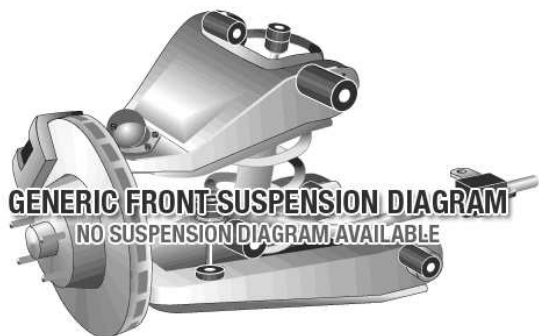

MAZDA 121 DB1031, DB1032-52 & DB1033-53 - 12/1990 -...

Página 1



Aplicaci...	Descripción	Referencia	Kits por...	Contenido del Kit	
DEL.	Control Arm Lower-Inner Bushing	MPU-1318K	1	Bushings, Inner Tubes	
DEL.	Sway Bar Mount To Chassis Bushing Measure bar diameter 22,24,26mm available	MPU-1478-__K	1	Bushings	
DEL.	Sway Bar To Lower Control Arm Kit Measure bush, 25mm length & flange diameter 47mm	MPU-0161K	1	Bushings	
DEL.	Sway Bar To Lower Control Arm Kit Measure bush, 20mm length & flange diameter 36mm	MPU-1477K	1	Bushings	



## MAZDA 121 Sedan & Coupe - 3/1976 - 1978

Página 1

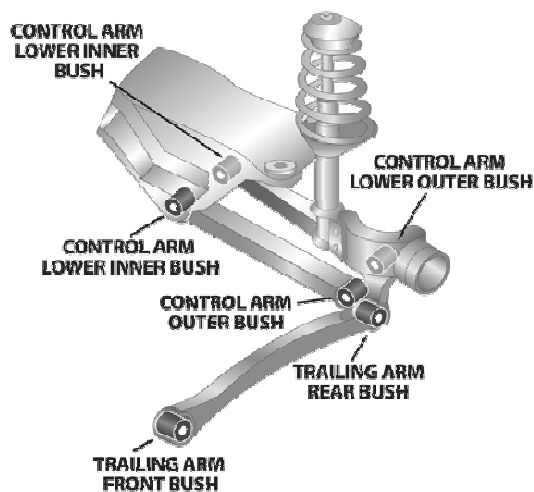
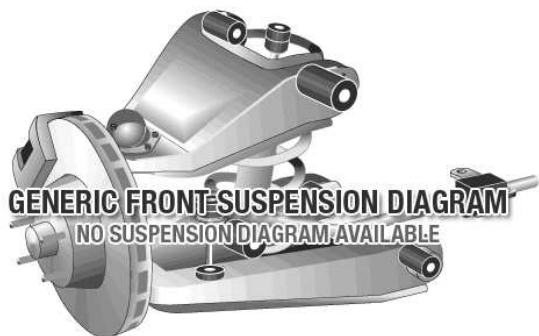





Aplicaci...	Descripción	Referencia	Kits por...	Contenido del Kit	
DEL.	Idler Arm Bushing	MPU-2002K	1	Bushings	
DEL.	Sway Bar Link Bushing Kit	MPU-2092BK	1	Bushings	
DEL.	Sway Bar Mount To Chassis Bushing Bar dia14,16,17,18,19,20,21,22,23,24,25,26,27 available	MPU-1452-__K	1	Bushings	
TRAS.	Trailing Arm Lower Front Bushing	MPU-0436K	1	Bushings, Inner Tubes	
TRAS.	Trailing Arm Lower Rear Bushing	MPU-0437K	1	Inner Tubes, Bushings	
TRAS.	Trailing Arm Upper Front Bushing	MPU-0435K	1	Bushings, Inner Tubes	
TRAS.	Trailing Arm Upper Rear Bushing	MPU-0434K	1	Inner Tubes, Bushings	

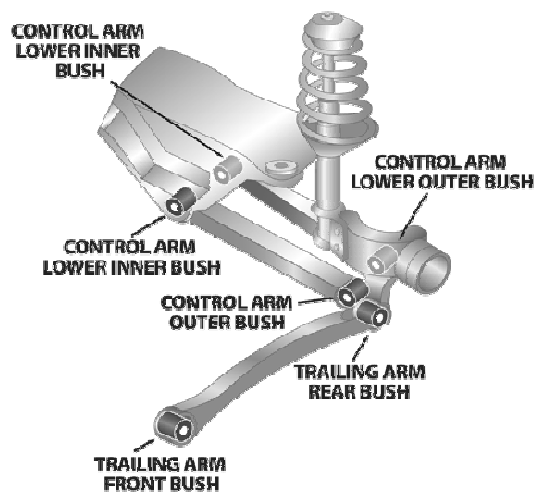
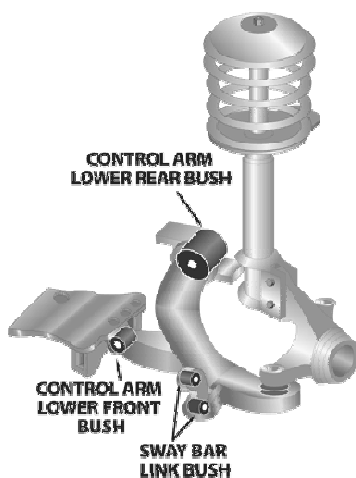

**MAZDA Cosmo / Eunos JC - 1990 - 1996**

Página 1









Aplicaci...	Descripción	Referencia	Kits por...	Contenido del Kit	
DEL.	Control Arm Lower Rear Bushing	<b>MPU-2023K</b>	1	Inner Tubes, Bushings	
DEL.	Control Arm Lower-Front Bushing	<b>MPU-2024K</b>	1	Bushings, Bushings	
TRAS.	Diagonal Support Upper-Inner Kit	<b>MPU-2022K</b>	1	Bushings, Inner Tubes	

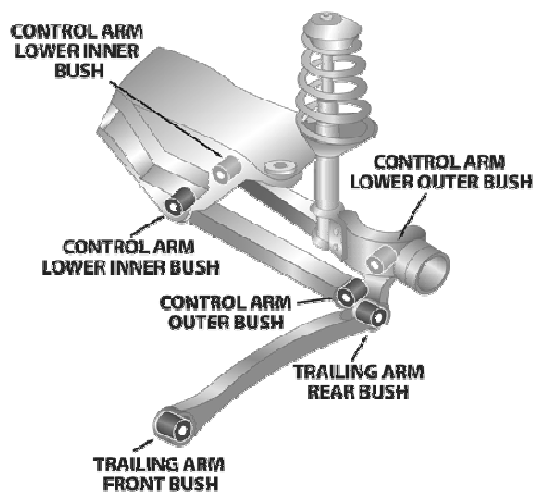
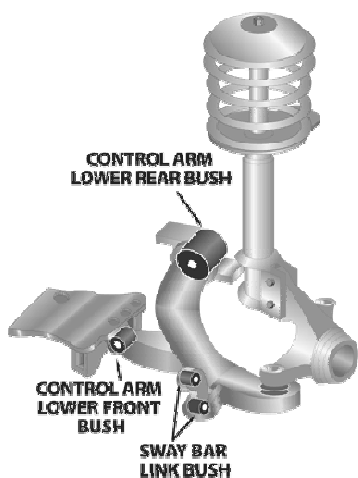

## MAZDA Tribute YU Series Wagon - 2/2001 - 2005

Página 1









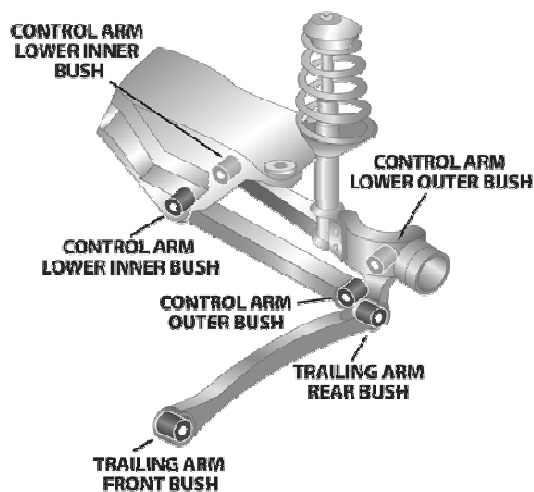
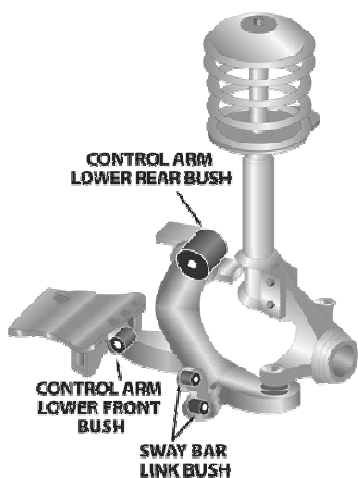

Aplicaci...	Descripción	Referencia	Kits por...	Contenido del Kit	
DEL.	Control Arm Lower-Inner Rear Eccentric 1 x offset & 1 x standard bushing	<b>MPU-3417K</b>	1	Inst Sheet, Outer Shells, Inner Tubes, Bushings	
DEL.	Control Arm Lower-Inner Rear Eccentric 2 x offset bushing	<b>MPU-3418K</b>	1	Inst Sheet, Outer Shells, Inner Tubes, Bushings	
DEL.	Control Arm Lower-Inner Rear Kit Standard replacement	<b>MPU-3416K</b>	1	Inst Sheet, Outer Shells, Inner Tubes, Bushings	
DEL.	Sway Bar Mount Bushing Measure bar diameter, 20mm available	<b>MPU-0895-__K</b>	1	Bushings	



## MAZDA MX6 Coupe ( GE10L1 ) 2WS & 4WS - 11/1991 - 1997

Página 1









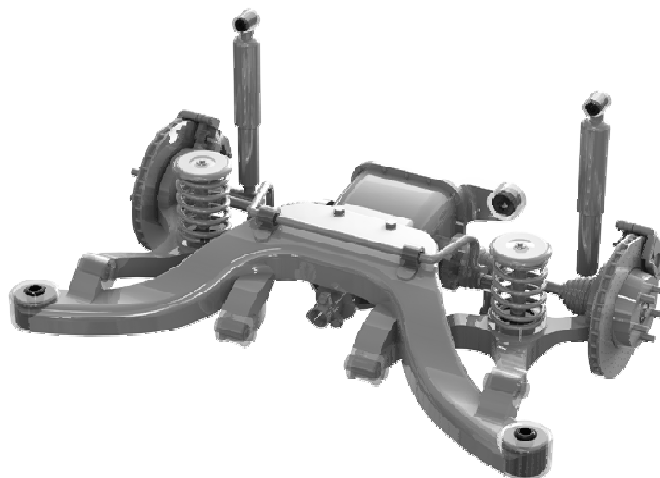
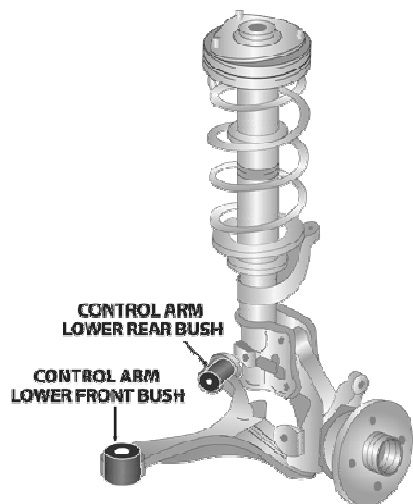

Aplicaci...	Descripción	Referencia	Kits por...	Contenido del Kit	
DEL.	Control Arm Lower Rear Bushing PS & DS standard	<b>MPU-1280K</b>	1	Washers, Outer Shells, Inner Tubes, Bushings	 SPF1280K
DEL.	Control Arm Lower Rear Bushing PS increased DS standard caster	<b>MPU-1281K</b>	1	Bushings, Inner Tubes, Outer Shells, Washers	 I 2 8 1 K
DEL.	Control Arm Lower Rear Bushing PS & DS increased caster	<b>MPU-1282AK</b>	1	Washers, Outer Shells, Inner Tubes, Bushings	 I 2 8 2 A K
DEL.	Control Arm Lower Rear Bushing PS increased DS decrease caster	<b>MPU-1282K</b>	1	Washers, Outer Shells, Inner Tubes, Bushings	 I 2 8 2 K
DEL.	Control Arm Lower-Front Bushing	<b>MPU-1843K</b>	1	Inner Tubes, Bushings	 SPF1843K
TRAS.	Sway Bar Mount To Chassis Bushing Bar diameter 12,13,15,16,18,19,20,22mm ava,32mm wide bracket	<b>MPU-1826-__K</b>	1	Bushings	



## MAZDA RX8 Coupe ( FE1031 ) - 2003 - 2009

Página 1









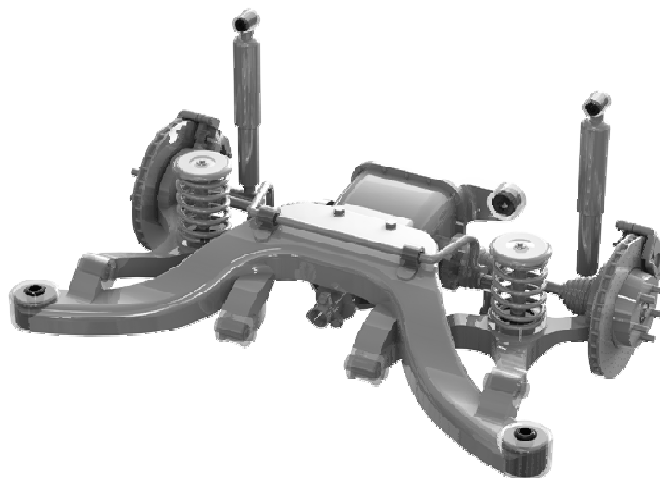
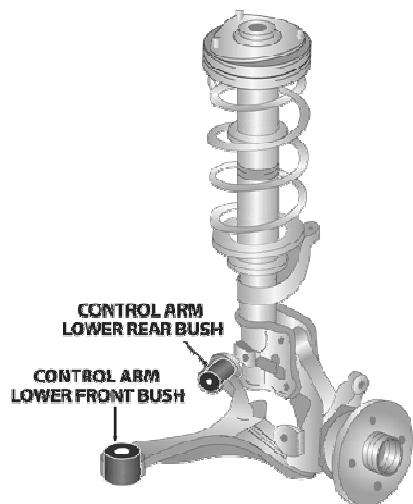

Aplicaci...	Descripción	Referencia	Kits por...	Contenido del Kit	
DEL.	Control Arm Lower-Inner Front Kit	<b>MPU-3255K</b>	1	Inner Tubes, Bushings	 SPF3255K
DEL.	Control Arm Lower-Inner Rear Eccentric 1 x Standard & 1 x offset bushing	<b>MPU-3257K</b>	1	Inst Sheet, Outer Shells, Inner Tubes, Bushings	
DEL.	Control Arm Lower-Inner Rear Eccentric 2 x Offset bushings	<b>MPU-3258K</b>	1	Inst Sheet, Outer Shells, Inner Tubes, Bushings	
DEL.	Control Arm Lower-Inner Rear Kit Standard replacement	<b>MPU-3256K</b>	1	Inst Sheet, Outer Shells, Inner Tubes, Bushings	
DEL.	Control Arm Upper-Inner Bushing Standard replacement	<b>MPU-3253K</b>	1	Inst Sheet, Inner Tubes, Bushings	 SPF3253K
DEL.	Control Arm Upper-Inner Eccentric Kit 4 x offset tubes for adjustment	<b>MPU-3254K</b>	1	Inst Sheet, Inner Tubes, Bushings	 SPF3254K
DEL.	Shock Absorber Lower Bushing Bushing mounted in control arm	<b>MPU-3259K</b>	1	Outer Shells, Inner Tubes, Bushings	 SPF3259K



## MAZDA RX8 Coupe ( FE1031 ) - 2003 - 2009

Página 2 (Continúa)







Aplicaci...	Descripción	Referencia	Kits por...	Contenido del Kit	
DEL.	Sway Bar Mount To Chassis Bushing Measure bar diameter	<b>MPU-1319-__K</b>	1	Bushings	
TRAS.	Control Arm Lower-Inner Bushing	<b>MPU-3403K</b>	1	Outer Shells, Inner Tubes, Bushings	 SPF3403K
TRAS.	Control Arm Upper-Inner Kit Standard replacement	<b>MPU-3401K</b>	1	Outer Shells, Inner Tubes, Bushings	 SPF3401K
TRAS.	Differential Centre Support Bush Standard replacement	<b>MPU-3404-70K</b>	1	Inner Tubes, Bushings	
TRAS.	Differential Centre Support Bush Performance use only, possible drivetrain NVH	<b>MPU-3404-80K</b>	1	Inner Tubes, Bushings	
TRAS.	Sway Bar Mount Bushing Measure bar diameter 14,16,17,18,19 & 21mm available.	<b>MPU-2535-__K</b>	1	Bushings	
TRAS.	Toe Control Arm - Inner Bushing	<b>MPU-3402K</b>	1	Inner Tubes, Bushings	 SPF3402K

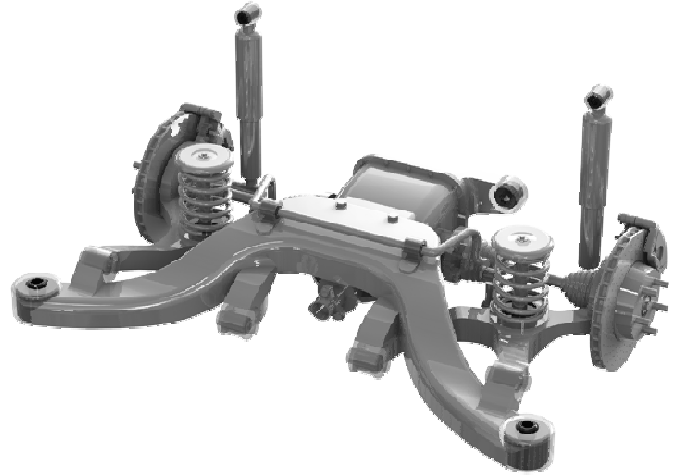
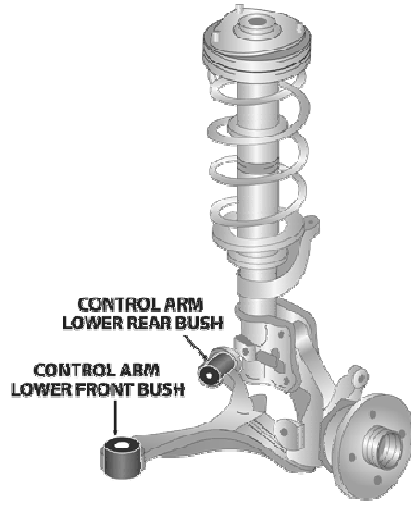

**MAZDA RX8 Coupe ( FE1031 ) - 2003 - 2009**

Página 3 (Continúa)



Aplicaci...	Descripción	Referencia	Kits por...	Contenido del Kit	
TRAS.	Trailing Arm Lower Bushing All Front & Rear bushings, Note- Rear bushing located in hub	<b>MPU-3264K</b>	1	Inner Tubes, Bushings	 SPF3264K
TRAS.	Trailing Arm Upper Front Bushing	<b>MPU-3400K</b>	1	Inner Tubes, Bushings	 SPF3400K









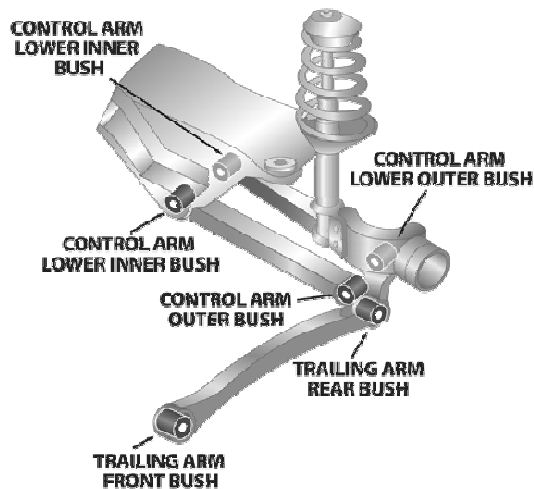
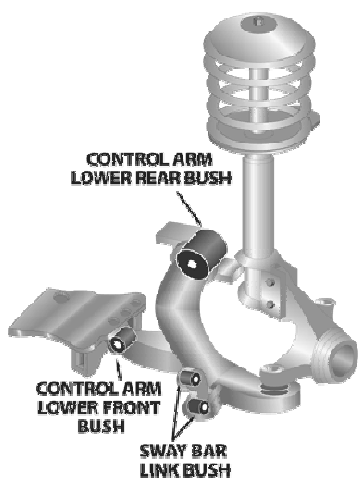

MAZDA 626 GF/GW Series Sedan & Hatch - 8/1997 - 2/2002

Página 1





Aplicaci...	Descripción	Referencia	Kits por...	Contenido del Kit	
DEL.	Control Arm Lower Rear Bushing PS & DS standard	<b>MPU-1280K</b>	1	Washers, Outer Shells, Inner Tubes, Bushings	 SPF1280K
DEL.	Control Arm Lower Rear Bushing PS increased DS standard caster	<b>MPU-1281K</b>	1	Bushings, Inner Tubes, Outer Shells, Washers	 1 2 8 1 K
DEL.	Control Arm Lower Rear Bushing PS & DS increased caster	<b>MPU-1282AK</b>	1	Washers, Outer Shells, Inner Tubes, Bushings	 1 2 8 2 AK
DEL.	Control Arm Lower Rear Bushing PS increased DS decrease caster	<b>MPU-1282K</b>	1	Washers, Outer Shells, Inner Tubes, Bushings	 1 2 8 2 K
DEL.	Control Arm Lower-Front Bushing	<b>MPU-1843K</b>	1	Inner Tubes, Bushings	 SPF1843K
TRAS.	Trailing Arm Lower Rear Bushing 40mm Outside diameter bushing	<b>MPU-0907K</b>	1	Inner Tubes, Bushings	 0 9 0 7 K

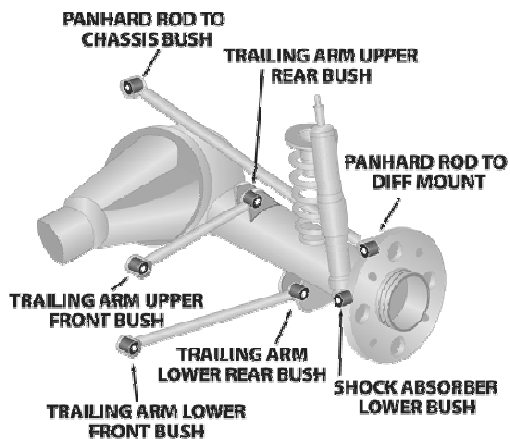
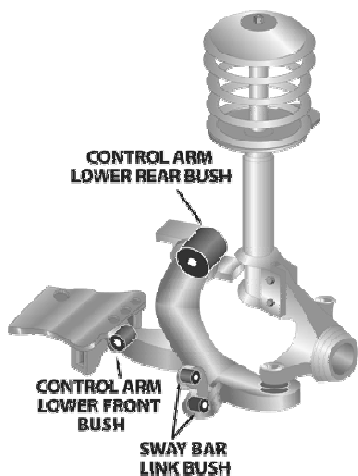

**MAZDA MPV LV10E 1 - 10/1993 - 4/1996**

Página 1









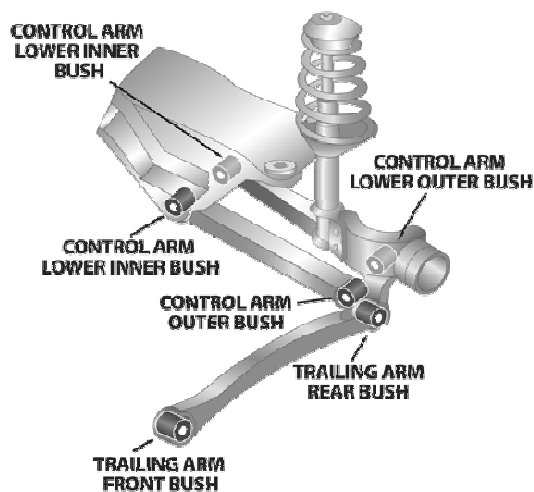
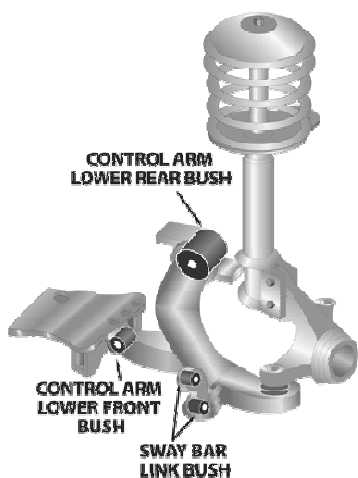

Aplicaci...	Descripción	Referencia	Kits por...	Contenido del Kit	
TRAS.	Trailing Arm Upper Bushing All	MPU-2725K	1	Inner Tubes, Bushings	



## MAZDA 6 GG1031/2 & GY1031/2 - 2002 - 2007

Página 1



Aplicaci...	Descripción	Referencia	Kits por...	Contenido del Kit	
DEL.	Control Arm Upper-Inner Kit Standard replacement bushings	<b>MPU-2951K</b>	1	Outer Shells, Inner Tubes, Bushings	
DEL.	Control Arm Lower-Inner Bushing	<b>MPU-2954K</b>	1	Outer Shells, Inner Tubes, Bushings	
DEL.	Control Arm Lower-Outer Bushing Also known as strut lower mount bushing	<b>MPU-2955K</b>	1	Inner Tubes, Bushings	
DEL.	Control Arm Upper-Inner Eccentric Kit 2 x standard & 2 x offset tubes, designed to correct camber alignment settings	<b>MPU-2952K</b>	1	Outer Shells, Inner Tubes, Bushings	
DEL.	Control Arm Upper-Inner Eccentric Kit 4 x offset tubes, designed for camber adjustment all points	<b>MPU-2953K</b>	1	Outer Shells, Inner Tubes, Bushings	
DEL.	Strut Bar To Subframe Standard replacement	<b>MPU-2956K</b>	1	Outer Shells, Inner Tubes, Bushings	
DEL.	Strut Bar To Subframe 1 x standard bushing and 1 x offset bushing, for caster correction.	<b>MPU-2957K</b>	1	Bushings, Outer Shells, Inner Tubes	



## MAZDA 6 GG1031/2 & GY1031/2 - 2002 - 2007

Página 2 (Continúa)

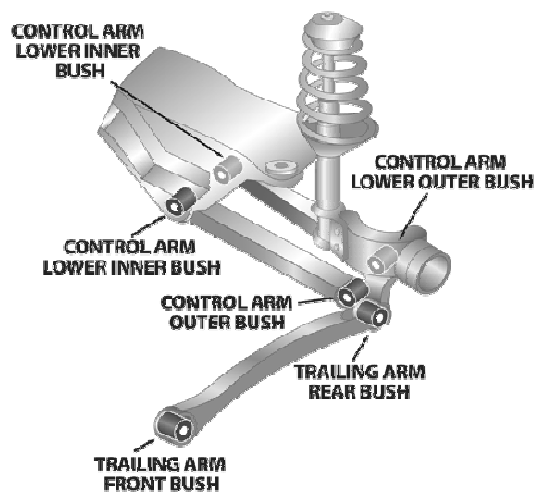
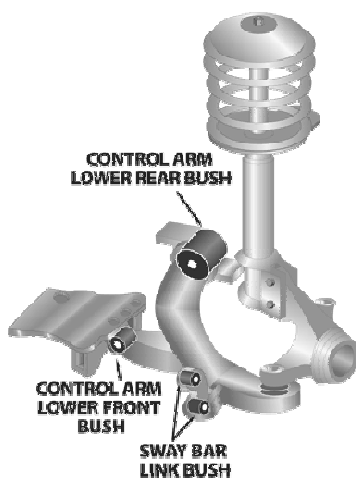



Aplicaci...	Descripción	Referencia	Kits por...	Contenido del Kit	
DEL.	Strut Bar To Subframe 2 x offset bushings, Increase or Decrease caster both sides	<b>MPU-2958K</b>	1	Bushings, Outer Shells, Inner Tubes	
DEL.	Sway Bar Mount To Chassis Bushing Measure bar diameter	<b>MPU-3910-__K</b>	1	Bushings	
TRAS.	Control Arm Upper-Inner / Outer Kit	<b>MPU-2555K</b>	2	Bushings, Outer Shells, Inner Tubes	
TRAS.	Sway Bar Mount To Chassis Bushing Please measure bar diameter	<b>MPU-3911-__K</b>	1	Bushings	

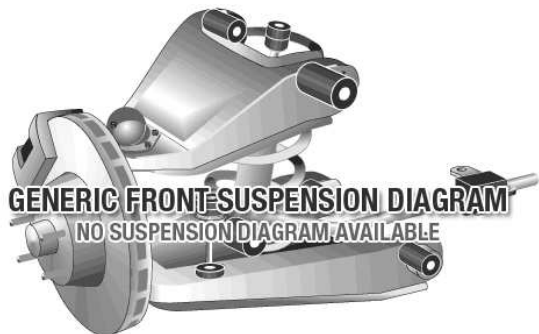

**MAZDA 6 MPS - 2005 - 2007**

Página 1



Aplicaci...	Descripción	Referencia	Kits por...	Contenido del Kit	
TRAS.	Sway Bar Mount To Chassis Bushing Please measure bar diameter	<b>MPU-3911-__K</b>	1	Bushings	



**MAZDA BT50 BT50 - 11/2006 - 2011**

Página 1

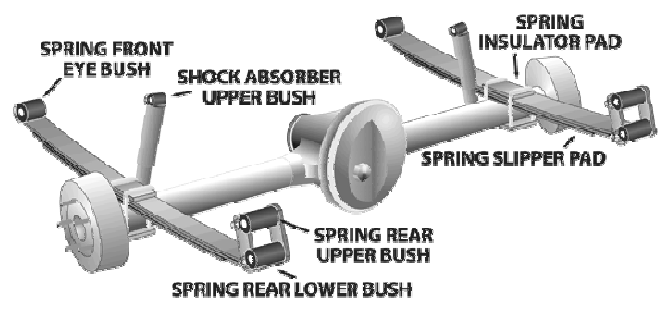
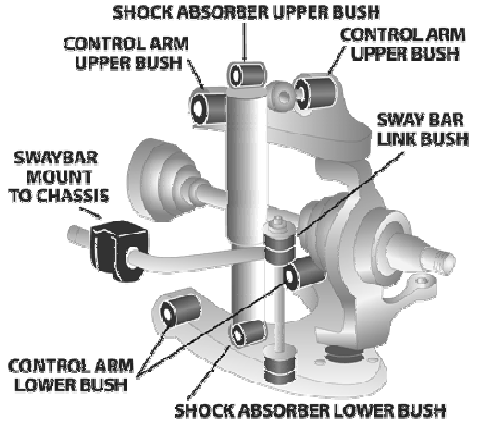







Aplicaci...	Descripción	Referencia	Kits por...	Contenido del Kit	
DEL.	Idler Arm Bushing	<b>MPU-1076K</b>	1	Bushings	
DEL.	Sway Bar Link Bushing Kit	<b>MPU-3762K</b>	1	Inst Sheet, Washers, Bushings	
DEL.	Sway Bar Mount To Chassis Bushing Measure bar diameter	<b>MPU-3760-__K</b>	1	Bushings	
TRAS.	Leaf Spring Bushing All Complete rear leaf spring bush kit including upper in chassis KIT CONTAINS - SPF2670K x 1, SPF0502K x 1,...	<b>MPK-145K</b>	1	Inner Tubes, Bushings	
TRAS.	Spring Front Eye Bushing	<b>MPU-2670K</b>	1	Inner Tubes, Bushings	
TRAS.	Spring Rear Eye Bushing	<b>MPU-0502K</b>	1	Bushings	
TRAS.	Spring Shackle Upper Bushing	<b>MPU-0753K</b>	1	Bushings	



**MAZDA BT50 BT50 GEN 2 - 11/2011 - ON**

Página 1



Aplicaci...	Descripción	Referencia	Kits por...	Contenido del Kit	
DEL.	Spring Seat Bushing	<b>MPU-4093K</b>	1	Bushings	
TRAS.	Spring Front Eye Bushing	<b>MPU-3802K</b>	1	Inner Tubes, Bushings	
TRAS.	Spring Rear Bushing All This kit contains - SPF3802K x 1, SPF3803K x 1, SPF3804K x 1	<b>MPK-168K</b>	1	Inner Tubes, Bushings	
TRAS.	Spring Rear Lower Bushing	<b>MPU-3804K</b>	1	Bushings	
TRAS.	Spring Shackle Upper Bushing	<b>MPU-3803K</b>	1	Bushings	



## MAZDA 3 Mk1 & Mk2 - 2004 - 2013

Página 1

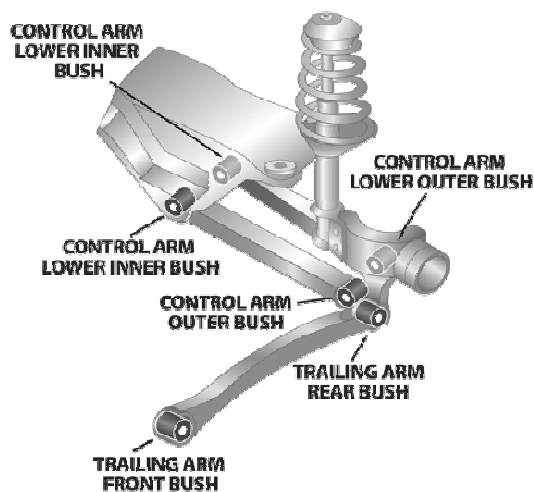
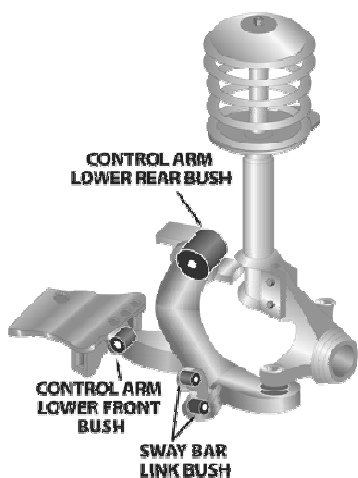

Aplicaci...	Descripción	Referencia	Kits por...	Contenido del Kit	
DEL.	Control Arm Lower-Inner Front Kit	<b>MPU-3115K</b>	1	Inner Tubes, Bushings	
DEL.	Control Arm Lower-Inner Rear Eccentric 2 x offset bushings; Approximately 0.5 degree caster split per bush.	<b>MPU-3370K</b>	1	Inst Sheet, Outer Shells, Inner Tubes, Bushings	
DEL.	Control Arm Lower-Inner Rear Eccentric 1 x standard & 1 x offset; Approximately 0.5 degree caster change.	<b>MPU-3369K</b>	1	Inst Sheet, Outer Shells, Inner Tubes, Bushings	
DEL.	Control Arm Lower-Inner Rear Kit Standard Replacement.	<b>MPU-3368K</b>	1	Inst Sheet, Outer Shells, Inner Tubes, Bushings	
DEL.	SuperPro Enhancement kit (Front Only) This Kit Contains	<b>MPK-171K</b>	1	Washers, Outer Shells, Inner Tubes, Bushings	
DEL.	Sway Bar Mount Bushing Replacement bushing for original bar with flats where bushing is positioned; Not suited to MPS...	<b>MPU-3114-__K</b>	1	Bushings	
DEL.	Sway Bar Mount Bushing After-market round sway bar; Bar diameters 20,21,22mm available.	<b>MPU-2141-__K</b>	1	Bushings	









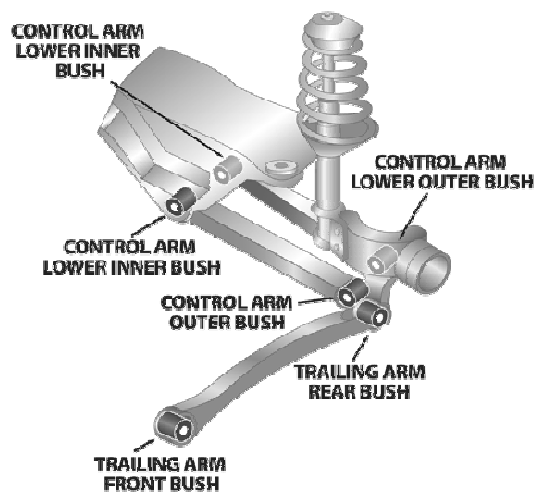
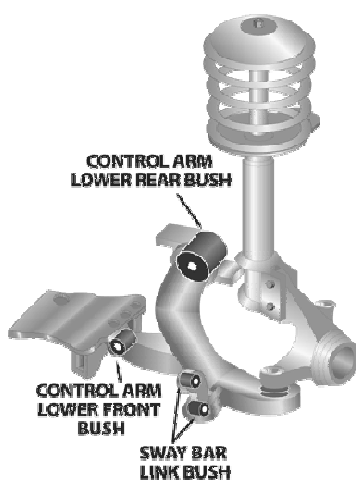

## MAZDA 3 Mk1 & Mk2 - 2004 - 2013

Página 2 (Continúa)



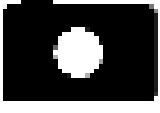



Aplicaci...	Descripción	Referencia	Kits por...	Contenido del Kit	
F & R	SuperPro Alignment Kit KIT CONTAINS	<b>MPK-170K</b>	1	Washers, Outer Shells, Inner Tubes, Bushings	
F & R	SuperPro Enhancement Kit THIS KIT CONTAINS	<b>MPK-169K</b>	1	Washers, Outer Shells, Inner Tubes, Bushings	
TRAS.	Blade Control Arm Front Kit Do not remove original shell.	<b>MPU-3466K</b>	1	Inst Sheet, Inner Tubes, Bushings	
TRAS.	Control Arm Lower-Inner & Outer Kit Front.	<b>MPU-2323K</b>	1	Outer Shells, Inner Tubes, Bushings	
TRAS.	Control Arm Lower-Inner & Outer Kit Rear.	<b>MPU-2324K</b>	1	Outer Shells, Inner Tubes, Bushings	
TRAS.	Control Arm Upper-Inner or Outer Kit Standard replacement; 1 x kit required for each position.	<b>MPU-2325K</b>	2	Outer Shells, Inner Tubes, Bushings	
TRAS.	Control Arm Upper-Inner or Outer..... Eccentric Bushing Camber adjustable, via offset tube (-1 to +1 degree adjustment); 1 x...	<b>MPU-2326K</b>	2	Outer Shells, Inner Tubes, Bushings	

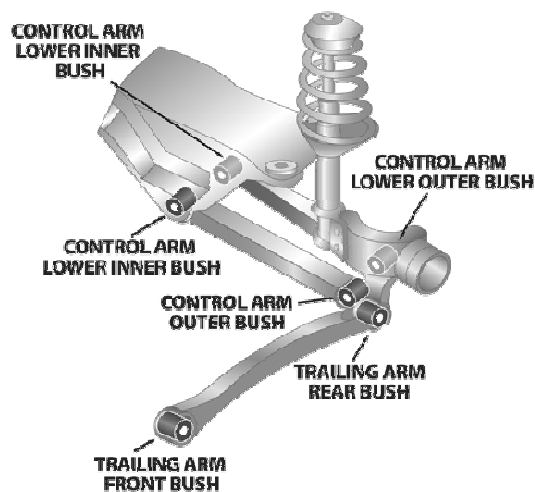
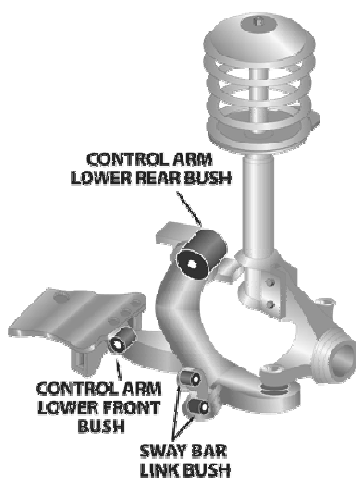

## MAZDA 3 Mk1 & Mk2 - 2004 - 2013

Página 3 (Continúa)









Aplicaci...	Descripción	Referencia	Kits por...	Contenido del Kit	
TRAS.	SuperPro Enhancement Kit (Rear Only) THIS KIT CONTAINS - SPF2325K x 2,SPF2323K x 1,SPF2324K x 1,SPF3466K (STD).	<b>MPK-172K</b>	1	Outer Shells, Inner Tubes, Bushings	
TRAS.	Sway Bar Mount Bushing After-market round sway bar; Bar diameters 20,21,22mm available.	<b>MPU-2141-__K</b>	1	Bushings	

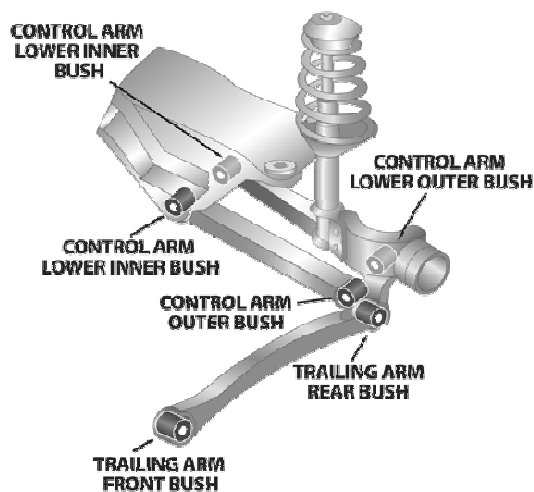
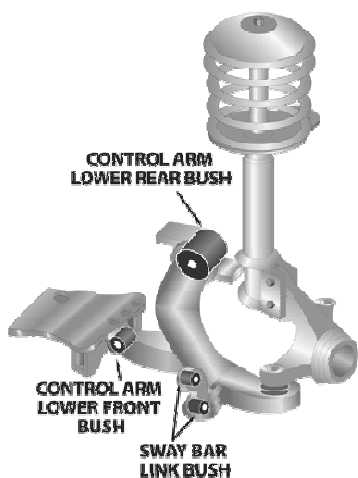

MAZDA 2 / Demio DY10Y2 - 6/2005 - 8/2007

Página 1



Aplicaci...	Descripción	Referencia	Kits por...	Contenido del Kit	
DEL.	Control Arm Lower-Inner Front Kit	<b>MPU-3241K</b>	1	Inner Tubes, Bushings	
DEL.	Control Arm Lower-Inner Rear Eccentric 1 x Standard bushing & 1 x Offset bushing	<b>MPU-3243K</b>	1	Inst Sheet, Washers, Outer Shells, Inner Tubes, Bushings	
DEL.	Control Arm Lower-Inner Rear Eccentric 2 x Offset bushing	<b>MPU-3244K</b>	1	Inst Sheet, Washers, Outer Shells, Inner Tubes, Bushings	
DEL.	Control Arm Lower-Inner Rear Kit Standard replacement	<b>MPU-3242K</b>	1	Inst Sheet, Washers, Outer Shells, Inner Tubes, Bushings	



**MAZDA 2 / Demio DE - 2007 - ON**

Página 1

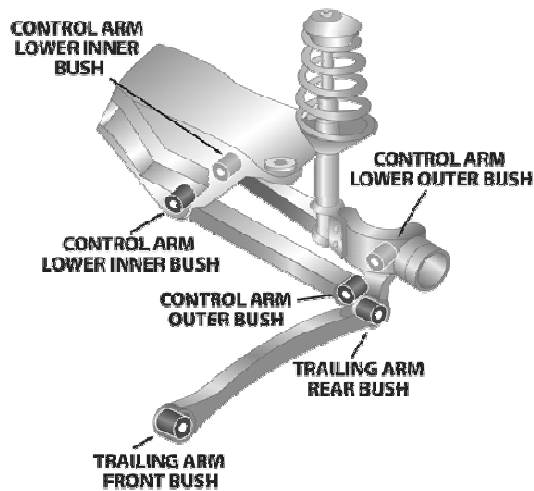
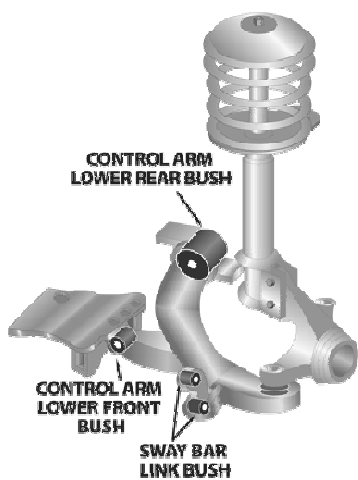







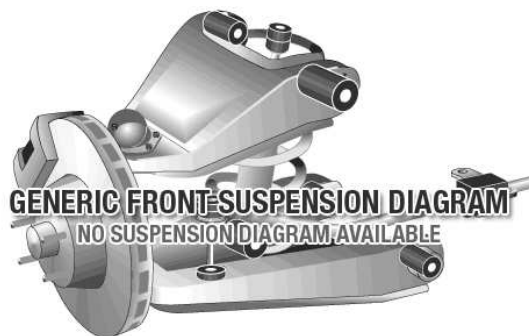
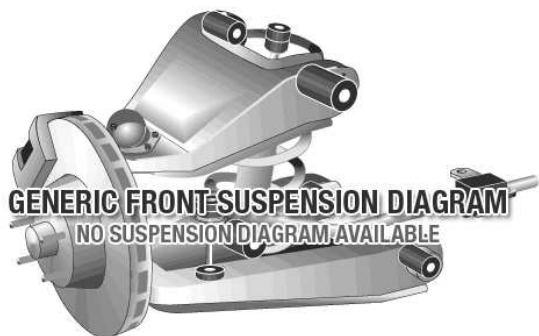

Aplicaci...	Descripción	Referencia	Kits por...	Contenido del Kit	
DEL.	Control Arm Lower-Inner Front Kit	<b>MPU-3637K</b>	1	Inner Tubes, Bushings	
DEL.	Control Arm Lower-Inner Rear Kit	<b>MPU-3636K</b>	1	Outer Shells, Inner Tubes, Bushings	
DEL.	Sway Bar Mount To Chassis Bushing Available sizes - 19mm	<b>MPU-3638-__K</b>	1	Bushings	
TRAS.	Beam Axle Pivot Bushing O.E# D651-28-460	<b>MPU-3640K</b>	1	Inner Tubes, Bushings	



## MAZDA 5 / Premacy Mk2 & Mk3 - 2005 - 2012

Página 1









Aplicaci...	Descripción	Referencia	Kits por...	Contenido del Kit	
DEL.	Control Arm Lower-Inner Front Kit	<b>MPU-3115K</b>	1	Inner Tubes, Bushings	
DEL.	Control Arm Lower-Inner Rear Eccentric 2 x offset bushings; Approximately 0.5 degree caster split per bush.	<b>MPU-3370K</b>	1	Inst Sheet, Outer Shells, Inner Tubes, Bushings	
DEL.	Control Arm Lower-Inner Rear Eccentric 1 x standard & 1 x offset; Approximately 0.5 degree caster change.	<b>MPU-3369K</b>	1	Inst Sheet, Outer Shells, Inner Tubes, Bushings	
DEL.	Control Arm Lower-Inner Rear Kit Standard Replacement.	<b>MPU-3368K</b>	1	Inst Sheet, Outer Shells, Inner Tubes, Bushings	
DEL.	Sway Bar Mount Bushing Replacement bushing for original bar with flats where bushing is positioned; Not suited to MPS...	<b>MPU-3114-__K</b>	1	Bushings	
DEL.	Sway Bar Mount Bushing After-market round sway bar; Bar diameters 20,21,22mm available.	<b>MPU-2141-__K</b>	1	Bushings	
TRAS.	Blade Control Arm Front Kit Do not remove original shell.	<b>MPU-3466K</b>	1	Inst Sheet, Inner Tubes, Bushings	

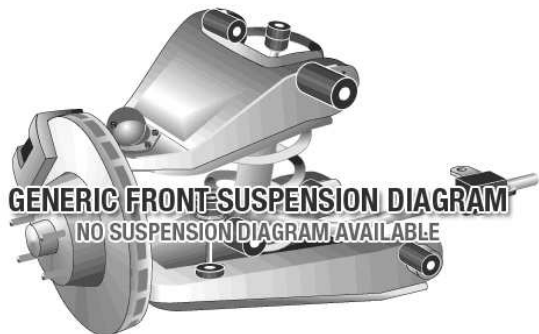

## MAZDA 5 / Premacy Mk2 & Mk3 - 2005 - 2012

Página 2 (Continúa)





Aplicaci...	Descripción	Referencia	Kits por...	Contenido del Kit	
TRAS.	Control Arm Lower-Inner & Outer Kit Front.	<b>MPU-2323K</b>	1	Outer Shells, Inner Tubes, Bushings	
TRAS.	Control Arm Lower-Inner & Outer Kit Rear.	<b>MPU-2324K</b>	1	Outer Shells, Inner Tubes, Bushings	
TRAS.	Control Arm Upper-Inner or Outer Kit Standard replacement; 1 x kit required for each position.	<b>MPU-2325K</b>	2	Outer Shells, Inner Tubes, Bushings	
TRAS.	Control Arm Upper-Inner or Outer..... Eccentric Bushing Camber adjustable, via offset tube (-1 to +1 degree adjustment); 1 x...	<b>MPU-2326K</b>	2	Outer Shells, Inner Tubes, Bushings	
TRAS.	Sway Bar Mount Bushing After-market round sway bar; Bar diameters 20,21,22mm available.	<b>MPU-2141-__K</b>	1	Bushings	



**MAZDA 5 / Premacy Mk1 - 1999 - 2004**

Página 1









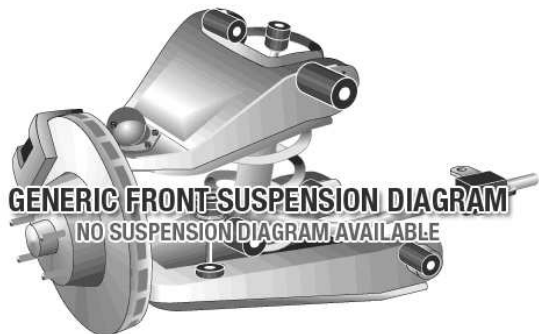

Aplicaci...	Descripción	Referencia	Kits por...	Contenido del Kit	
TRAS.	Trailing Arm Lower Front Bushing	<b>MPU-0907K</b>	1	Inner Tubes, Bushings	
TRAS.	Trailing Arm Lower Rear Bushing	<b>MPU-0906K</b>	1	Inner Tubes, Bushings	



**MAZDA 3 MPS, MAZDASPEED Mk1 & Mk2 MPS,...**

Página 1



Aplicaci...	Descripción	Referencia	Kits por...	Contenido del Kit	
DEL.	Control Arm Lower-Inner Front Kit	<b>MPU-3115K</b>	1	Inner Tubes, Bushings	
DEL.	Control Arm Lower-Inner Rear Eccentric 2 x offset bushings; Approximately 0.5 degree caster split.	<b>MPU-3370K</b>	1	Inst Sheet, Outer Shells, Inner Tubes, Bushings	
DEL.	Control Arm Lower-Inner Rear Eccentric 1 x standard & 1 x offset; Approximately 0.5 degree caster change.	<b>MPU-3369K</b>	1	Inst Sheet, Outer Shells, Inner Tubes, Bushings	
DEL.	Control Arm Lower-Inner Rear Kit Standard Replacement.	<b>MPU-3368K</b>	1	Inst Sheet, Outer Shells, Inner Tubes, Bushings	
DEL.	SuperPro Enhancement kit (Front Only) This Kit Contains	<b>MPK-171K</b>	1	Washers, Outer Shells, Inner Tubes, Bushings	
DEL.	Sway Bar Mount To Chassis Bushing Measure bar diameter	<b>MPU-3902-__K</b>	1	Bushings	
F & R	SuperPro Alignment Kit KIT CONTAINS	<b>MPK-170K</b>	1	Washers, Outer Shells, Inner Tubes, Bushings	









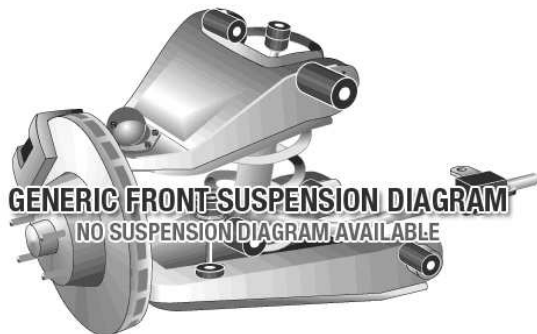



## MAZDA 3 MPS, MAZDASPEED Mk1 & Mk2 MPS,...

Página 2 (Continúa)









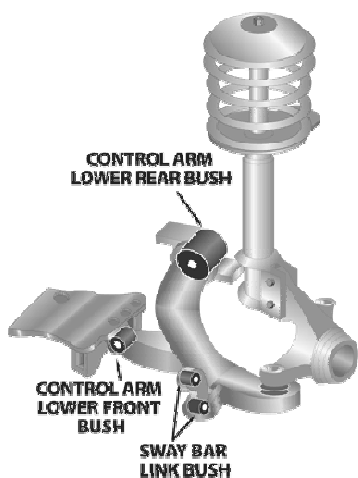

Aplicaci...	Descripción	Referencia	Kits por...	Contenido del Kit	
F & R	SuperPro Enhancement Kit THIS KIT CONTAINS	<b>MPK-169K</b>	1	Washers, Outer Shells, Inner Tubes, Bushings	
TRAS.	Control Arm Upper-Inner or Outer Kit Standard replacement; 1 x kit required for each position.	<b>MPU-2325K</b>	2	Outer Shells, Inner Tubes, Bushings	
TRAS.	Blade Control Arm Front Kit Do not remove original shell.	<b>MPU-3466K</b>	1	Inst Sheet, Inner Tubes, Bushings	
TRAS.	Control Arm Lower-Inner & Outer Kit Front.	<b>MPU-2323K</b>	1	Outer Shells, Inner Tubes, Bushings	
TRAS.	Control Arm Lower-Inner & Outer Kit Rear.	<b>MPU-2324K</b>	1	Outer Shells, Inner Tubes, Bushings	
TRAS.	Control Arm Upper-Inner or Outer..... Eccentric Bushing Camber adjustable, via offset tube (-1 to +1 degree adjustment); 1 x...	<b>MPU-2326K</b>	2	Outer Shells, Inner Tubes, Bushings	
TRAS.	SuperPro Enhancement Kit (Rear Only) THIS KIT CONTAINS - SPF2325K x 2,SPF2323K x 1,SPF2324K x 1,SPF3466K (STD).	<b>MPK-172K</b>	1	Outer Shells, Inner Tubes, Bushings	



MAZDA 323 FA4,FA5 ( Rear wheel drive ) - 3/1977 - 1981

Página 1









Aplicaci...	Descripción	Referencia	Kits por...	Contenido del Kit	
DEL.	Sway Bar To Lower Control Arm Kit	<b>MPU-0161K</b>	1	Bushings	 0161K
DEL.	Control Arm Lower-Inner Bushing Cast steel arm	<b>MPU-0314K</b>	1	Bushings, Inner Tubes	 0 3 1 4 K
DEL.	Control Arm Lower-Inner Bushing Fabricated Arm = ( Pressed metal arm )	<b>MPU-0433K</b>	1	Bushings, Inner Tubes	 0 4 3 3 K
DEL.	Idler Arm Bushing	<b>MPU-1003K</b>	1	Bushings	 1 0 0 3 K
DEL.	Sway Bar Mount To Chassis Bushing Measure bar diameter 19,20,21,22,23,24,27,30mm available	<b>MPU-1454-__K</b>	1	Bushings	
TRAS.	Shock Absorber Upper / Lower Bushing	<b>MPU-2755SK</b>	1	Bushings	 SPF2755SK
TRAS.	Spring Front Eye Bushing Wagon, 40mm OD bushing, 6mm wide flange	<b>MPU-0037K</b>	1	Bushings	 0037K

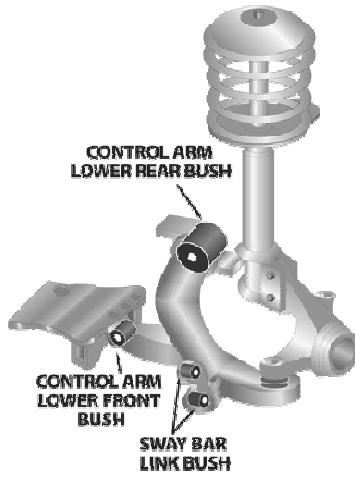

MAZDA 323 FA4,FA5 ( Rear wheel drive ) - 3/1977 - 1981

Página 2 (Continúa)







Aplicaci...	Descripción	Referencia	Kits por...	Contenido del Kit	
TRAS.	Spring Rear Eye Bushing Wagon	<b>MPU-0544K</b>	1	Bushings	
TRAS.	Spring Shackle Upper Bushing Wagon	<b>MPU-0544K</b>	1	Bushings	
TRAS.	Trailing Arm Lower Front Bushing Coil spring model, with 45mm long crush tube.	<b>MPU-2355K</b>	1	Inner Tubes, Bushings	
TRAS.	Trailing Arm Lower Rear Bushing Coil spring model	<b>MPU-2356K</b>	1	Bushings, Inner Tubes	
TRAS.	Trailing Arm Upper Bushing All Coil spring model	<b>MPU-2432K</b>	1	Bushings, Inner Tubes	

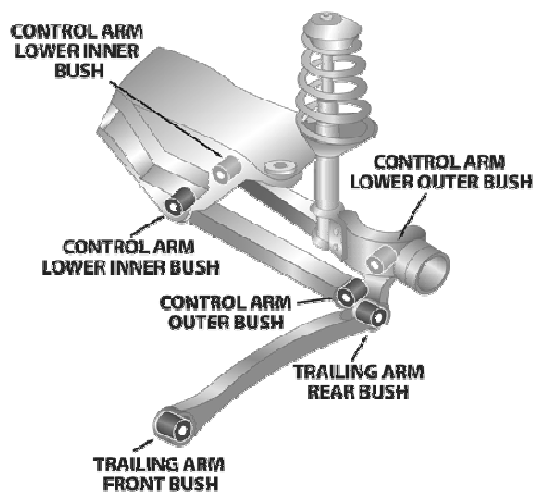
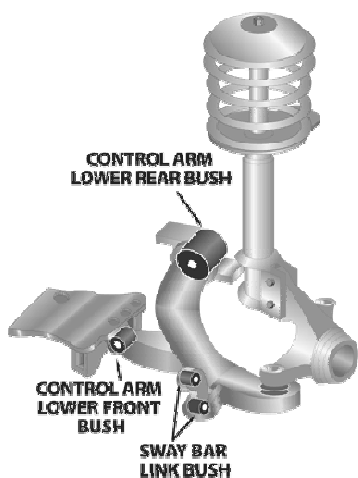

## MAZDA 626 GC Series Sedan & Hatch - 2/1983 - 9/1987

Página 1





Aplicaci...	Descripción	Referencia	Kits por...	Contenido del Kit	
DEL.	Control Arm Lower-Inner Bushing OD 34mm, Normally 9/1985 - 9/1987 must measure	<b>MPU-0539K</b>	1	Inner Tubes, Bushings	
DEL.	Control Arm Lower-Inner Bushing OD 30mm, Normally 1982 - 8/1985 must measure	<b>MPU-0540K</b>	1	Inner Tubes, Bushings	
DEL.	Sway Bar Link Bushing Kit	<b>MPU-0903K</b>	1	Bushings	
DEL.	Sway Bar Mount To Chassis Bushing Measure bar diameter 20,22mm available	<b>MPU-0895-__K</b>	1	Bushings	
TRAS.	Control Arm-Rear Inner & Outer Kit	<b>MPU-2458K</b>	1	Bushings, Inner Tubes, Washers	
TRAS.	Control Arm-Front Inner & Outer Kit	<b>MPU-2456K</b>	1	Washers, Inner Tubes, Bushings	
TRAS.	Sway Bar Link Bushing Kit	<b>MPU-0903K</b>	1	Bushings	

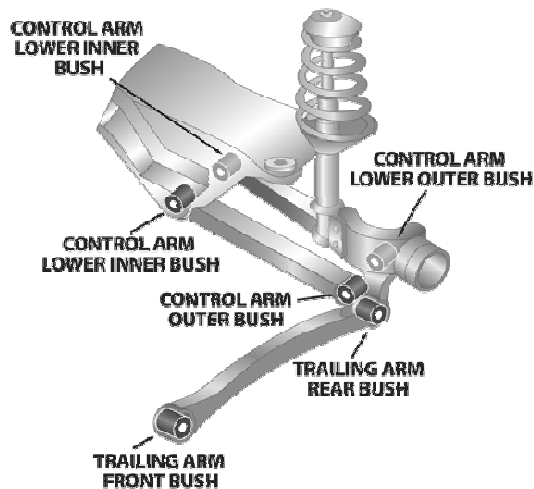
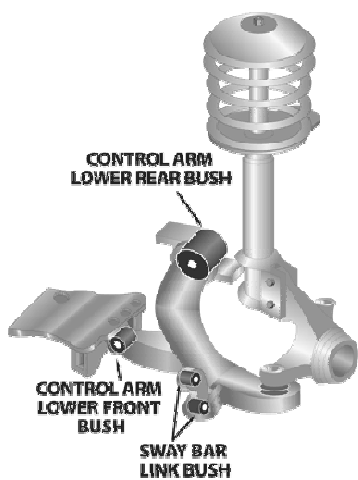

## MAZDA 626 GC Series Sedan & Hatch - 2/1983 - 9/1987

Página 2 (Continúa)



Aplicaci...	Descripción	Referencia	Kits por...	Contenido del Kit	
TRAS.	Sway Bar Mount To Chassis Bushing Measure bar diameter 14,16,17,18,20mm available	MPU-0361-__K	1	Bushings	
TRAS.	Trailing Arm - Bushing Kit 4 x 40mm, 4 x 34mm OD bush	MPU-1279K	1	Inner Tubes, Bushings	
TRAS.	Trailing Arm - Bushing Kit 8 x 40mm OD bush	MPU-1412K	1	Bushings, Inner Tubes	



## MAZDA 626 GD Series Sedan, Hatch & GV Wagon - 11/1987 -...

Página 1

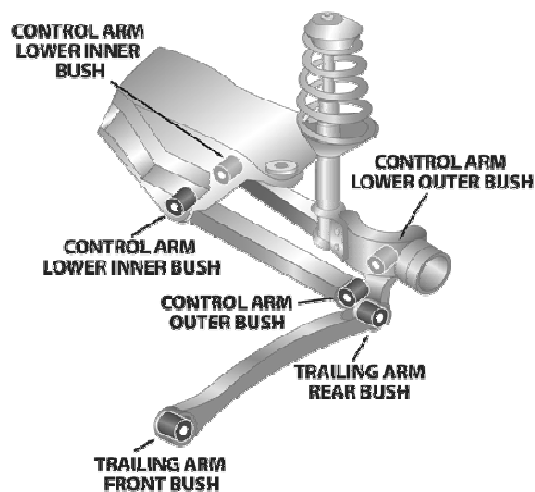
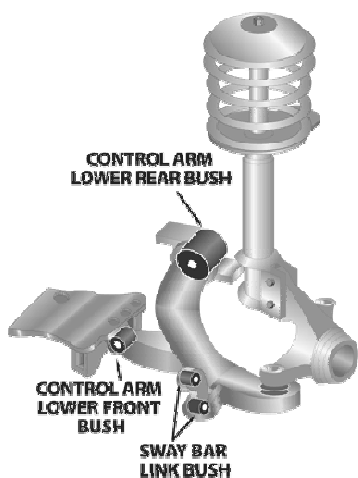

Aplicaci...	Descripción	Referencia	Kits por...	Contenido del Kit	
DEL.	Control Arm Lower Rear Bushing Replaces OE # KA10-34-460 Suits GV Wagon also	<b>MPU-1278-70K</b>	1	Inner Tubes, Bushings	
DEL.	Control Arm Lower-Front Bushing Replaces OE # KA10-34-470A, Suits GV Wagon also	<b>MPU-1278-80K</b>	1	Inner Tubes, Bushings	
DEL.	Sway Bar Link Bushing Kit	<b>MPU-0903K</b>	1	Bushings	
DEL.	Sway Bar Mount To Chassis Bushing Measure bar diameter 16,20,21,24mm available "32mm wide"	<b>MPU-0360-__K</b>	1	Bushings	
TRAS.	Control Arm Inner-Front & Rear Kit	<b>MPU-2066K</b>	1	Washers, Inner Tubes, Bushings	
TRAS.	Control Arm Outer Front & Rear Kit	<b>MPU-2071K</b>	1	Inner Tubes, Bushings	
TRAS.	Sway Bar Link Bushing Kit	<b>MPU-0903K</b>	1	Bushings	



## MAZDA 626 GD Series Sedan, Hatch & GV Wagon - 11/1987 -...

Página 2 (Continúa)

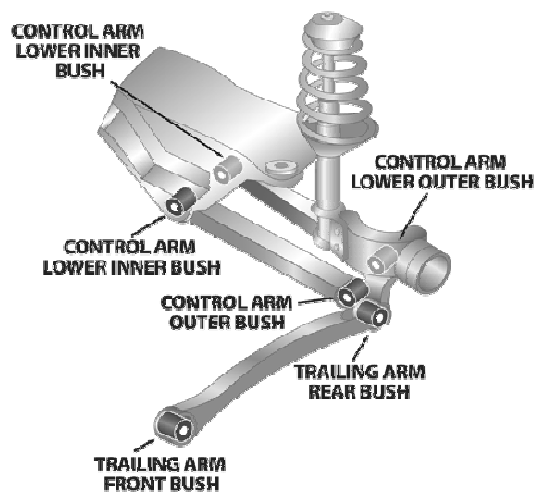
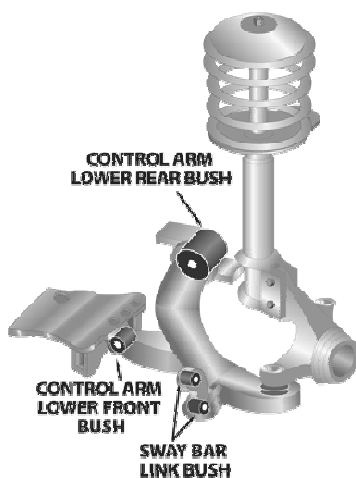



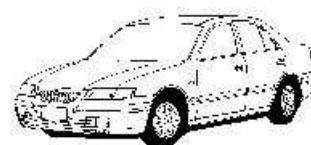



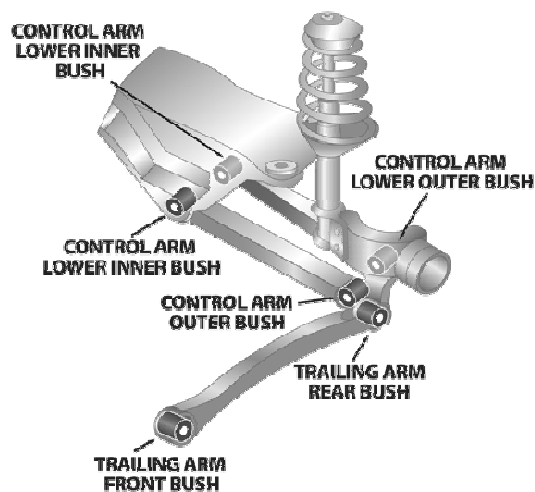
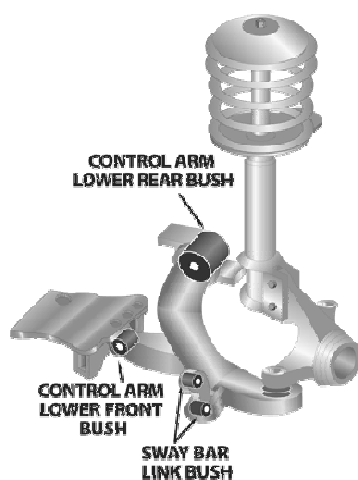

Aplicaci...	Descripción	Referencia	Kits por...	Contenido del Kit	
TRAS.	Sway Bar Link Upper Bushing 4WS	<b>MPU-0903-4K</b>	1	Bushings	
TRAS.	Sway Bar Mount Bushing Measure bar diameter 12, 14,16,17,18,20,22,23,24mm available	<b>MPU-0305-__K</b>	1	Bushings	
TRAS.	Trailing Arm - Front Bushing	<b>MPU-2064K</b>	1	Inner Tubes, Bushings	
TRAS.	Trailing Arm - Rear Bushing GD102 series, 40mm Outside diameter bushing	<b>MPU-0906K</b>	1	Inner Tubes, Bushings	
TRAS.	Trailing Arm - Rear Bushing 44mm OD bush	<b>MPU-2065K</b>	1	Inner Tubes, Bushings	



## MAZDA 626 GE Series Sedan & Hatch - 1/1992 - 8/1997

Página 1



Aplicaci...	Descripción	Referencia	Kits por...	Contenido del Kit	
DEL.	Control Arm Lower Rear Bushing PS increased DS decrease caster	<b>MPU-1282K</b>	1	Washers, Outer Shells, Inner Tubes, Bushings	
DEL.	Control Arm Lower Rear Bushing PS & DS standard	<b>MPU-1280K</b>	1	Washers, Outer Shells, Inner Tubes, Bushings	
DEL.	Control Arm Lower Rear Bushing PS increased DS standard caster	<b>MPU-1281K</b>	1	Bushings, Inner Tubes, Outer Shells, Washers	
DEL.	Control Arm Lower Rear Bushing PS & DS increased caster	<b>MPU-1282AK</b>	1	Washers, Outer Shells, Inner Tubes, Bushings	
DEL.	Control Arm Lower Rear Bushing Wagon only 1992-1995 Replaces OE# KA10-34-460	<b>MPU-1278-70K</b>	1	Inner Tubes, Bushings	
DEL.	Control Arm Lower-Front Bushing	<b>MPU-1843K</b>	1	Inner Tubes, Bushings	
DEL.	Control Arm Lower-Front Bushing Wagon only 1992-1995, Replaces OE # KA10-34-470A	<b>MPU-1278-80K</b>	1	Inner Tubes, Bushings	



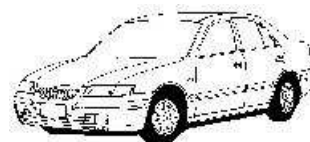

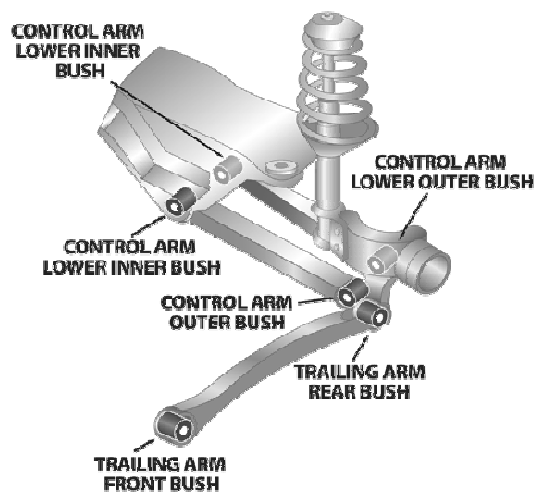
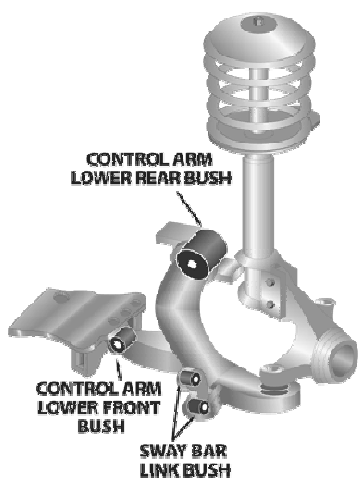

**MAZDA 626 GE Series Sedan & Hatch - 1/1992 - 8/1997**

Página 2 (Continúa)









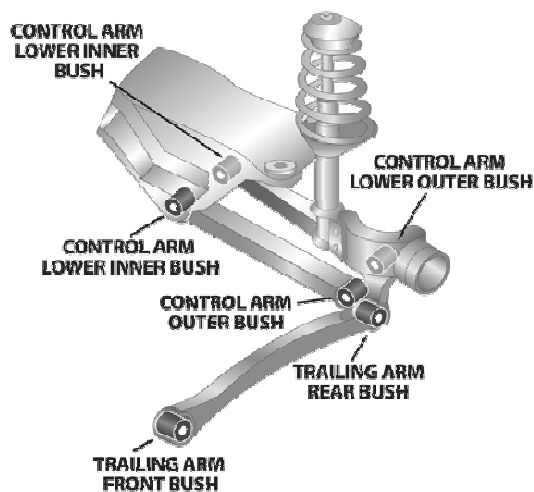
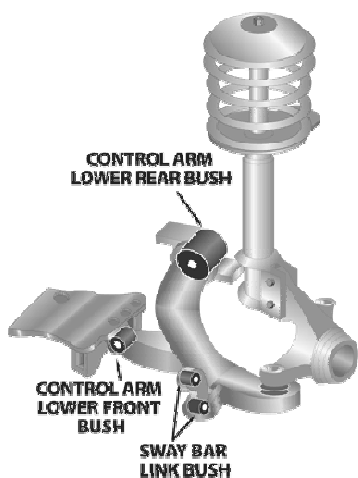

Aplicaci...	Descripción	Referencia	Kits por...	Contenido del Kit	
DEL.	Sway Bar Mount To Chassis Bushing Measure bar diameter, 19,20,21,22,23,25.4 & 26mm available.	<b>MPU-0202-__K</b>	1	Bushings	



MAZDA 929 LA4MS Sedan - 6/1978 - 2/1982

Página 1



Aplicaci...	Descripción	Referencia	Kits por...	Contenido del Kit	
DEL.	Idle Arm Bushing	MPU-2005K	1	Bushings	
DEL.	Sway Bar Link Bushing Kit	MPU-2092BK	1	Bushings	 SPF2092BK
DEL.	Sway Bar Mount To Chassis Bushing Measure bar diameter 29mm available	MPU-1164-__K	1	Bushings	
TRAS.	Shock Absorber Lower Bushing	MPU-2178-16K	1	Bushings	 SPF2178- K
TRAS.	Leaf Spring Bushing All	MPU-1235K	1	Bushings	 1 2 3 5 K
TRAS.	Panhard Rod To Chassis Mount Kit	MPU-1095K	1	Inner Tubes, Bushings	 1 0 9 5 K
TRAS.	Panhard Rod To Diff Mount Bushing	MPU-1096K	1	Bushings, Inner Tubes	 1 0 9 6 K



MAZDA 929 LA4MS Sedan - 6/1978 - 2/1982

Página 2 (Continúa)

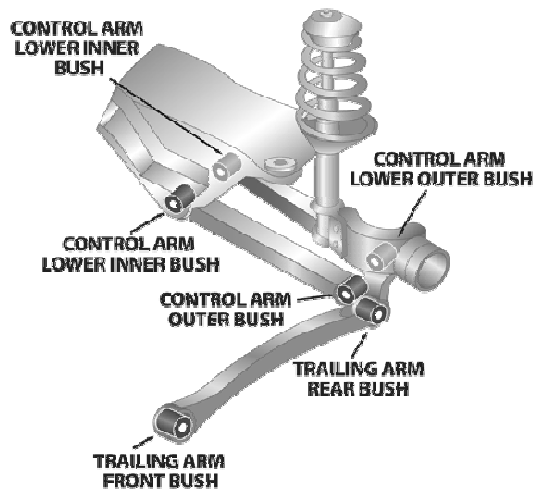
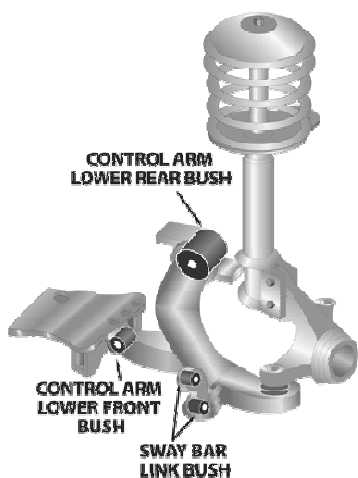







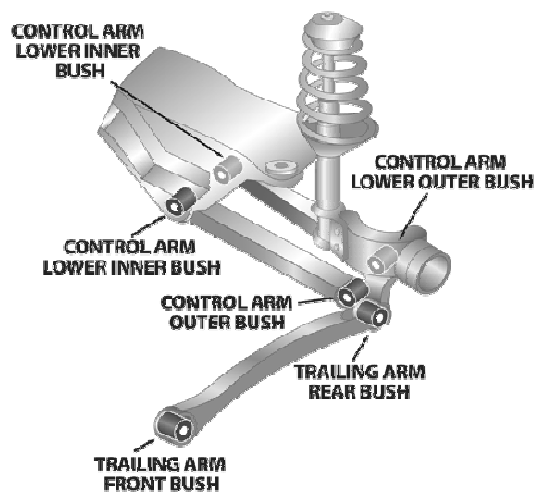
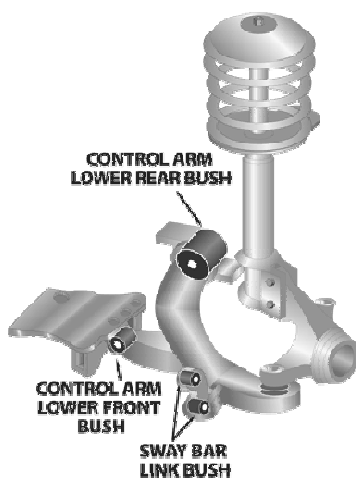

Aplicaci...	Descripción	Referencia	Kits por...	Contenido del Kit	
TRAS.	Shock Absorber Upper Bushing	MPU-2755SK	1	Bushings	
TRAS.	Spring Front Eye Bushing	MPU-1234K	1	Bushings	
TRAS.	Sway Bar Link Bushing Kit	MPU-0904K	1	Bushings	
TRAS.	Trailing Arm Lower Bushing All	MPU-0434K	2	Inner Tubes, Bushings	
TRAS.	Trailing Arm Upper Front Bushing	MPU-0435K	1	Bushings, Inner Tubes	
TRAS.	Trailing Arm Upper Rear Bushing	MPU-0434K	1	Inner Tubes, Bushings	



## MAZDA 929 LA4MS Wagon - 5/1978 - 4/1987

Página 1



Aplicaci...	Descripción	Referencia	Kits por...	Contenido del Kit	
DEL.	Idler Arm Bushing	MPU-2005K	1	Bushings	
DEL.	Sway Bar Link Bushing Kit	MPU-2092BK	1	Bushings	
DEL.	Sway Bar Mount To Chassis Bushing Measure bar diameter 29mm available	MPU-1164-__K	1	Bushings	
TRAS.	Spring Front Eye Bushing	MPU-1234K	1	Bushings	
TRAS.	Spring Rear Bushing All	MPU-1235K	1	Bushings	
TRAS.	Sway Bar Mount To Chassis Bushing Measure bar diameter 14,16,18,20,21,23,24,25.4mm ava	MPU-0738-__K	1	Bushings	



**MAZDA 929 HB Series - 2/1984 - 4/1987**

Página 1

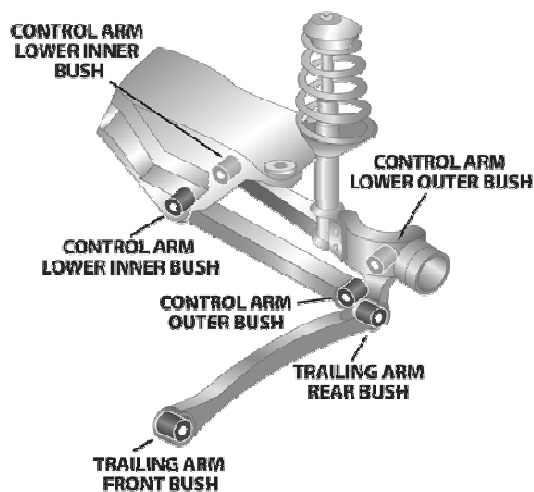
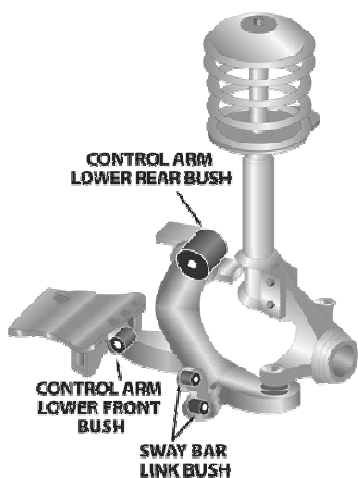



Aplicaci...	Descripción	Referencia	Kits por...	Contenido del Kit	
DEL.	Control Arm Lower-Inner Bushing	<b>MPU-1218K</b>	1	Inner Tubes, Bushings	
DEL.	Strut Bar To Chassis Mount Kit	<b>MPU-0065-19K</b>	1	Bushings	
DEL.	Sway Bar Link Bushing Kit	<b>MPU-2092BK</b>	1	Bushings	
TRAS.	Sway Bar Link Bushing Kit	<b>MPU-0903K</b>	1	Bushings	
TRAS.	Sway Bar Mount To Chassis Bushing Measure bar diameter , 13mm available	<b>MPU-1072-__K</b>	1	Bushings	

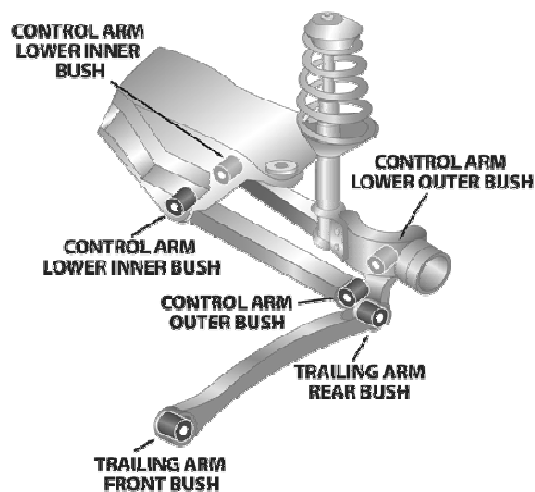
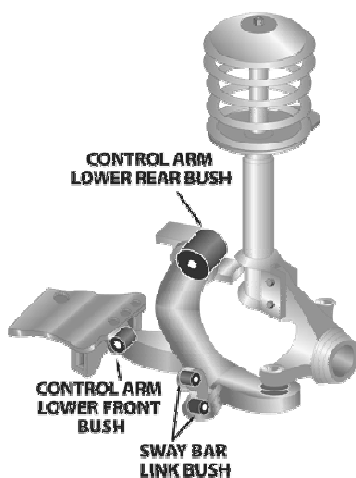

**MAZDA 929 HC Series - 5/1987 - 7/1991**

Página 1





Aplicaci...	Descripción	Referencia	Kits por...	Contenido del Kit	
DEL.	Strut Bar Bushing Must remove original shell	<b>MPU-1328K</b>	1	Inner Tubes, Bushings	

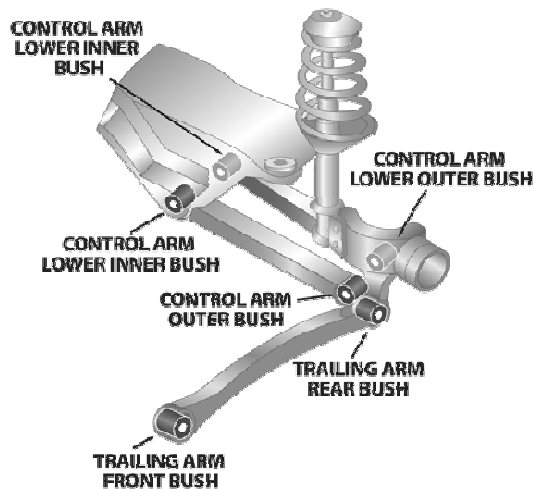
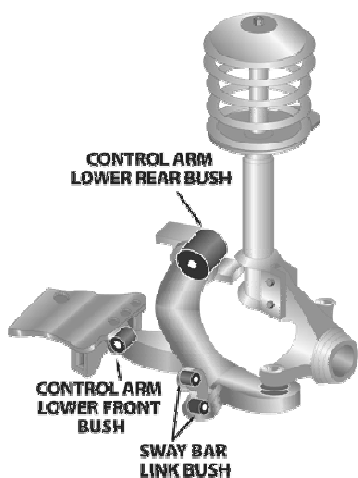

**MAZDA 929 HD Series - 7/1991 - 3/1996**

Página 1



Aplicaci...	Descripción	Referencia	Kits por...	Contenido del Kit	
DEL.	Strut Bar To Chassis Mount Kit Standard, 69.5mm long tube, Bracket width 40mm	<b>MPU-1202K</b>	1	Inner Tubes, Bushings	



## MAZDA 929 Sedan & Coupe - 1973 - 1979

Página 1

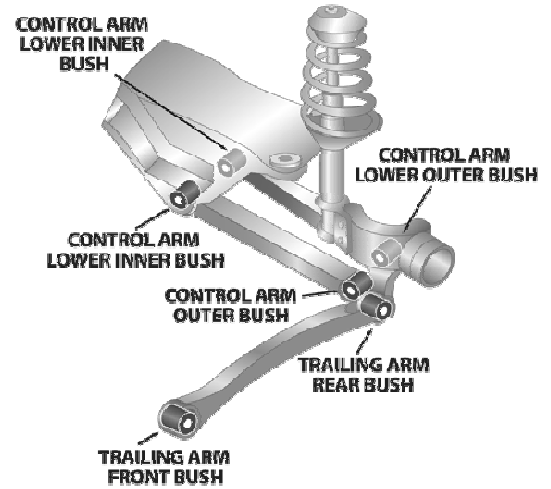
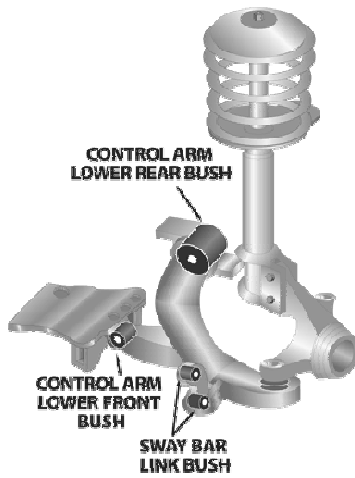

Aplicaci...	Descripción	Referencia	Kits por...	Contenido del Kit	
DEL.	Sway Bar To Lower Control Arm Kit Measure bush, 24mm length & flange diameter 47mm	<b>MPU-0161K</b>	1	Bushings	
DEL.	Control Arm Lower-Inner Bushing	<b>MPU-0595K</b>	1	Bushings, Inner Tubes	
DEL.	Idler Arm Bushing	<b>MPU-2002K</b>	1	Bushings	
DEL.	Sway Bar Mount To Chassis Bushing Flat Base, Bar diameter 19,20,21,22,23,25.4 & 26mm available	<b>MPU-0202-__K</b>	1	Bushings	
DEL.	Sway Bar Mount To Chassis Bushing Measure bar diameter 19,20,21,22,23,24,27,30mm available	<b>MPU-1454-__K</b>	1	Bushings	
TRAS.	Spring Front Eye Bushing 40mm OD bushing, 10mm wide flanges.	<b>MPU-0542K</b>	1	Bushings	
TRAS.	Spring Rear Eye Bushing 29.5mm OD bushing	<b>MPU-0543K</b>	1	Bushings	





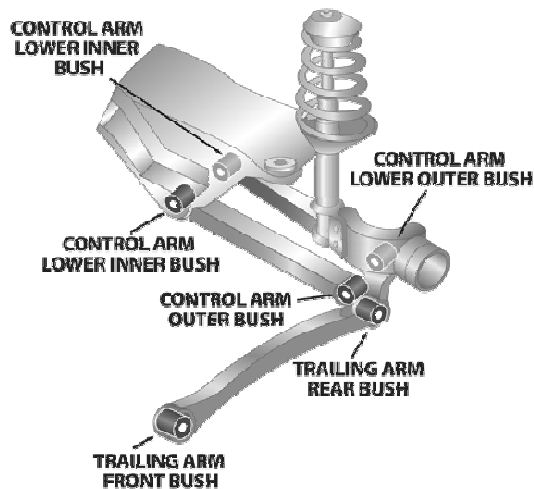
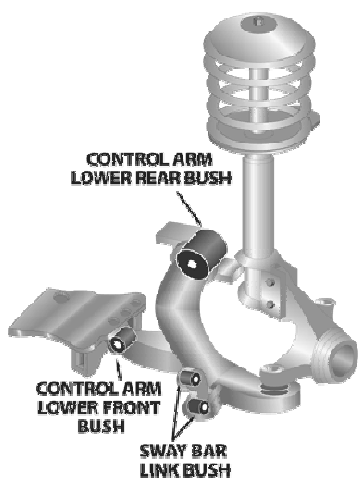

**MAZDA 929 Sedan & Coupe - 1973 - 1979**

Página 2 (Continúa)









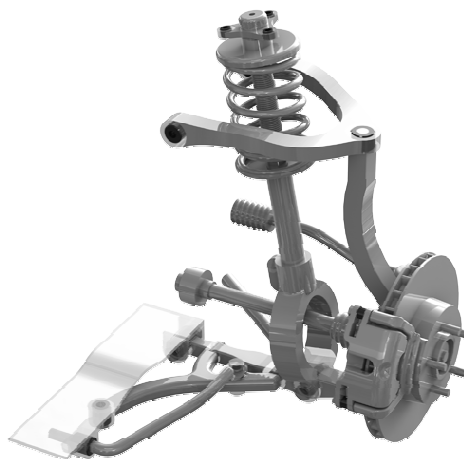
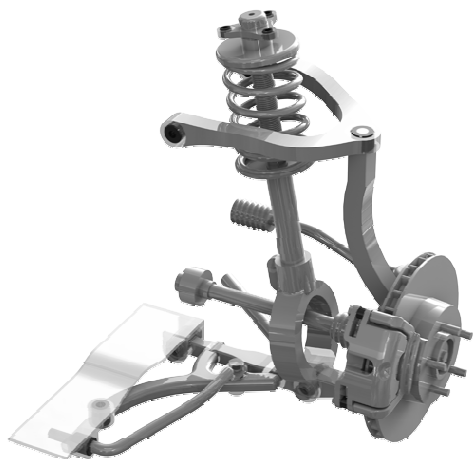

Aplicaci...	Descripción	Referencia	Kits por...	Contenido del Kit	
TRAS.	Spring Shackle Upper Bushing	MPU-0544K	1	Bushings	



## MAZDA MX5 Convertible NA3061 / NA30P3 - 10/1989 - ...

Página 1









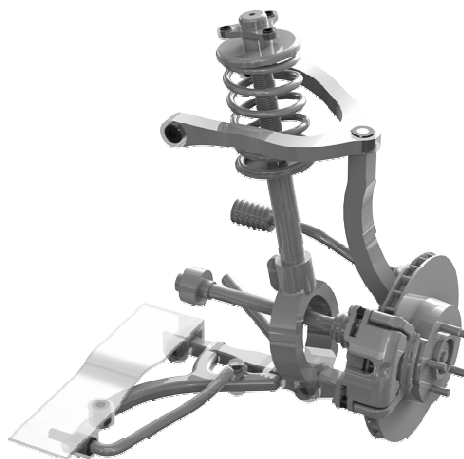
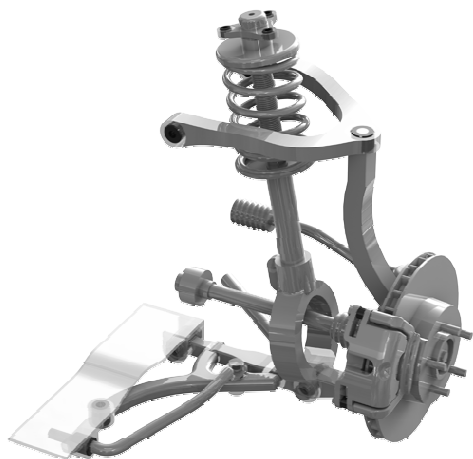

Aplicaci...	Descripción	Referencia	Kits por...	Contenido del Kit	
DEL.	Control Arm Lower-Inner Front Kit	<b>MPU-1984-80K</b>	1	Inner Tubes, Bushings	
DEL.	Control Arm Lower-Inner Front.....Eccentric Adjustable offset tubes, designed for racing purpose	<b>MPU-1984-80AK</b>	1	Inner Tubes, Bushings	
DEL.	Control Arm Lower-Inner Rear Eccentric Adjustable offset tubes, designed for racing purpose	<b>MPU-1985-80AK</b>	1	Inner Tubes, Bushings	
DEL.	Control Arm Lower-Inner Rear Kit	<b>MPU-1985-80K</b>	1	Inner Tubes, Bushings	
DEL.	Control Arm Upper-Inner Eccentric Kit Adjustable offset tubes, designed for racing only	<b>MPU-1986AK</b>	1	Washers, Inner Tubes, Bushings	
DEL.	Control Arm Upper-Inner Kit	<b>MPU-1986K</b>	1	Bushings, Inner Tubes, Washers	



## MAZDA MX5 Convertible NA3061 / NA30P3 - 10/1989 - ...

Página 2 (Continúa)









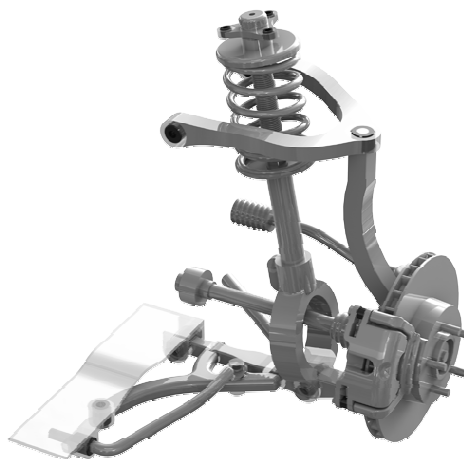
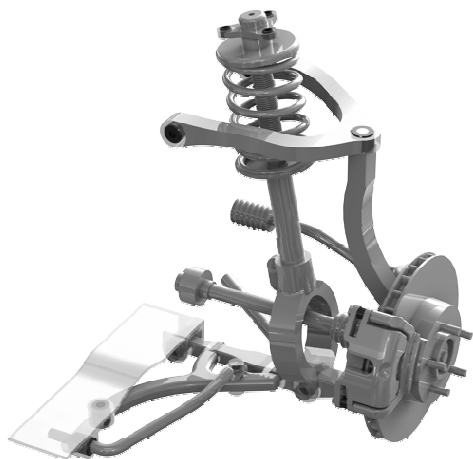

Aplicaci...	Descripción	Referencia	Kits por...	Contenido del Kit	
DEL.	Steering Rack & Pinion Mount Bush.....Power Steering Power Steering	<b>MPU-2762K</b>	1	Bushings	
DEL.	Steering Rack & Pinion Mount Bush....Manual Steering Manual Steering	<b>MPU-2764K</b>	1	Bushings	
DEL.	Sway Bar Link Bushing Kit Upper & lower	<b>MPU-1987K</b>	1	Washers, Inner Tubes, Bushings	
DEL.	Sway Bar Mount To Chassis Bushing Measure bar diameter 15,20,22,24,27mm available	<b>MPU-0615-__K</b>	1	Bushings	
F & R	SuperPro Alignment & Enhancement Kit SPF1984-80AKx1, SPF1985-80AKx1, SPF1986Kx1, SPF1987Kx2, SPF1988AKx1, SPF1990Kx1, SPF1991Kx1, See any notes...	<b>MPK-132NAK</b>	1	Washers, Inner Tubes, Bushings	
F & R	SuperPro Enhancement Kit SPF1984-80Kx1, SPF1985-80Kx1, SPF1986Kx1, SPF1987Kx1, SPF1988Kx1, SPF1988Kx1, SPF1990Kx1, SPF1991Kx1,SPF1987Kx1. See any notes listed...	<b>MPK-131NAK</b>	1	Washers, Inner Tubes, Bushings	



## MAZDA MX5 Convertible NA3061 / NA30P3 - 10/1989 -...

Página 3 (Continúa)





Aplicaci...	Descripción	Referencia	Kits por...	Contenido del Kit	
TRAS.	Control Arm Upper-Inner / Outer Kit	<b>MPU-1991K</b>	1	Inner Tubes, Bushings	
TRAS.	Control Arm Lower-Inner Bushing	<b>MPU-1988K</b>	1	Inner Tubes, Bushings	
TRAS.	Control Arm Lower-Inner Eccentric Kit Adjustable offset tubes, designed for racing purpose	<b>MPU-1988AK</b>	1	Inner Tubes, Bushings	
TRAS.	Control Arm Lower-Outer Bushing	<b>MPU-1990K</b>	1	Washers, Inner Tubes, Bushings	
TRAS.	Differential Mount Bushing Housing mounts void fillers	<b>MPU-2875K</b>	1	Bushings	
TRAS.	Differential Mount Bushing Housing mounts, Complete replacement bushing kit.	<b>MPU-2876K</b>	1	Inner Tubes, Bushings	
TRAS.	Sway Bar Link Bushing Kit Upper & lower	<b>MPU-1987K</b>	1	Washers, Inner Tubes, Bushings	

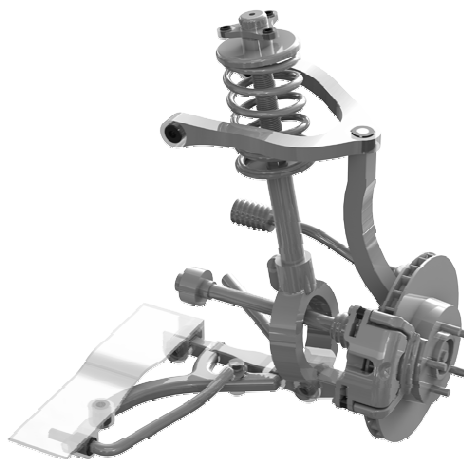
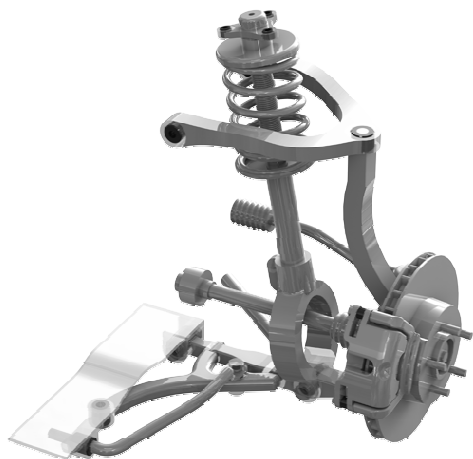

**MAZDA MX5 Convertible NA3061 / NA30P3 - 10/1989 - ...**

Página 4 (Continúa)





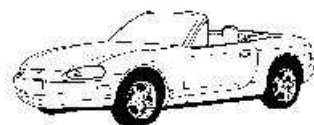



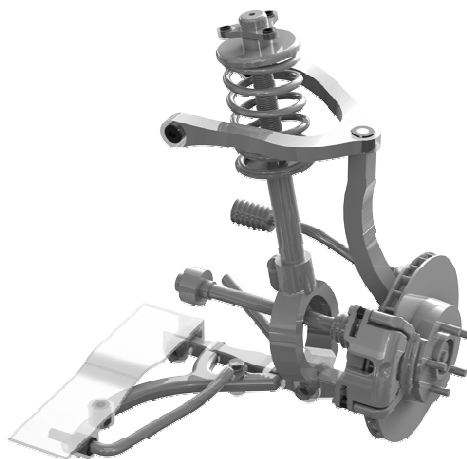
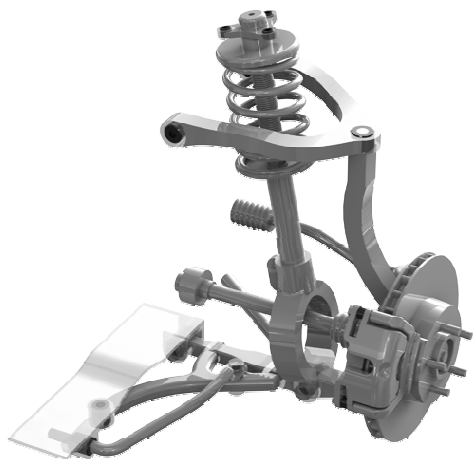

Aplicaci...	Descripción	Referencia	Kits por...	Contenido del Kit	
TRAS.	Sway Bar Mount To Chassis Bushing Measure bar diameter 11,12,13,14,16 & 22mm available	<b>MPU-0722-__K</b>	1	Bushings	



## MAZDA MX5 Convertible NB30P1 & NB30P2 - 3/1998 - 2003

Página 1









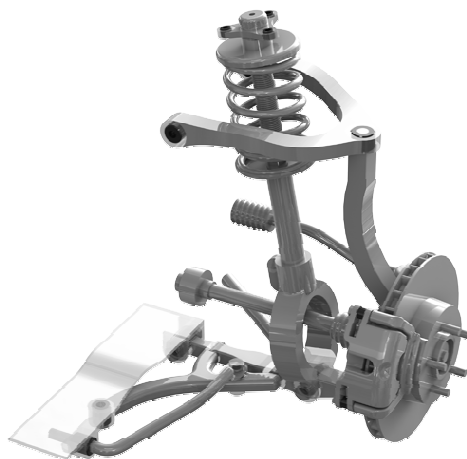
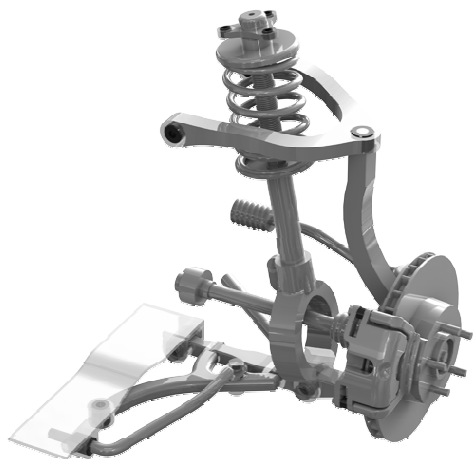

Aplicaci...	Descripción	Referencia	Kits por...	Contenido del Kit	
DEL.	Control Arm Upper-Inner Kit	<b>MPU-1986K</b>	1	Bushings, Inner Tubes, Washers	
DEL.	Control Arm Lower-Inner Front Kit	<b>MPU-1984-80K</b>	1	Inner Tubes, Bushings	
DEL.	Control Arm Lower-Inner Front.....Eccentric Adjustable offset tubes, designed for racing purpose	<b>MPU-1984-80AK</b>	1	Inner Tubes, Bushings	
DEL.	Control Arm Lower-Inner Rear Eccentric Adjustable offset tubes, designed for racing purpose	<b>MPU-1985-80AK</b>	1	Inner Tubes, Bushings	
DEL.	Control Arm Lower-Inner Rear Kit	<b>MPU-1985-80K</b>	1	Inner Tubes, Bushings	
DEL.	Control Arm Upper-Inner Eccentric Kit Adjustable offset tubes, designed for racing only	<b>MPU-1986AK</b>	1	Washers, Inner Tubes, Bushings	



## MAZDA MX5 Convertible NB30P1 & NB30P2 - 3/1998 - 2003

Página 2 (Continúa)





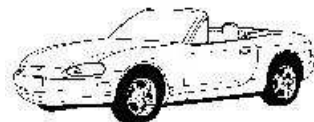



Aplicaci...	Descripción	Referencia	Kits por...	Contenido del Kit	
DEL.	Sway Bar Mount To Chassis Bushing Measure bar diameter 15,20,22,24,27mm available	<b>MPU-0615-__K</b>	1	Bushings	
F & R	SuperPro Alignment & Enhancement Kit SPF1984-80AKx1, SPF1985-80AKx1, SPF1986Kx1, SPF1988AKx1, SPF1990Kx1, SPF1991Kx1, See any notes listed against...	<b>MPK-132NBK</b>	1		
F & R	SuperPro Enhancement Kit SPF1984-80Kx1, SPF1985-80Kx1, SPF1986Kx1, SPF1988Kx1, SPF1990Kx1, SPF1991Kx1, See any notes...	<b>MPK-131NBK</b>	1		
TRAS.	Control Arm Lower-Inner Bushing	<b>MPU-1988K</b>	1	Inner Tubes, Bushings	
TRAS.	Control Arm Lower-Inner Eccentric Kit Adjustable offset tubes, designed for racing purpose	<b>MPU-1988AK</b>	1	Inner Tubes, Bushings	
TRAS.	Control Arm Lower-Outer Bushing	<b>MPU-1990K</b>	1	Washers, Inner Tubes, Bushings	

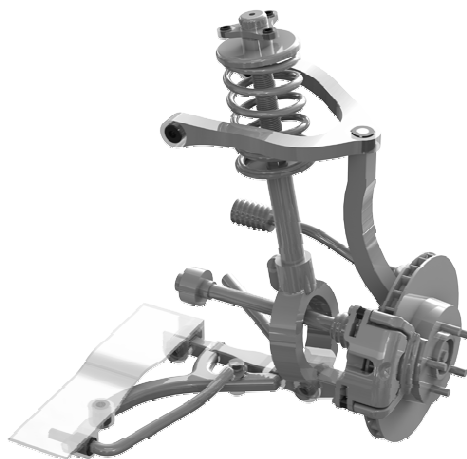
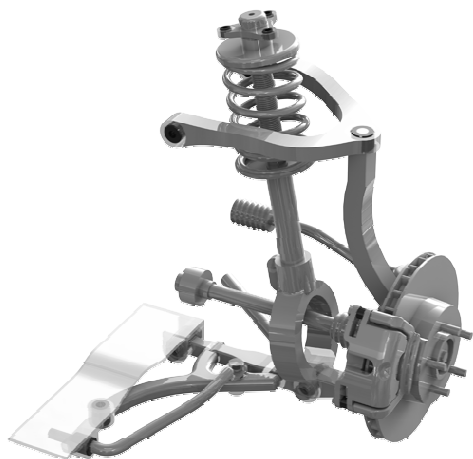

## MAZDA MX5 Convertible NB30P1 & NB30P2 - 3/1998 - 2003

Página 3 (Continúa)



Aplicaci...	Descripción	Referencia	Kits por...	Contenido del Kit	
TRAS.	Control Arm Upper-Inner / Outer Kit	<b>MPU-1991K</b>	1	Inner Tubes, Bushings	
TRAS.	Differential Mount Bushing Housing mounts void fillers	<b>MPU-2875K</b>	1	Bushings	
TRAS.	Differential Mount Bushing Housing mounts, Complete replacement bushing kit.	<b>MPU-2876K</b>	1	Inner Tubes, Bushings	
TRAS.	Sway Bar Mount To Chassis Bushing Measure bar diameter 11,12,13,14,16 & 22mm available	<b>MPU-0722-__K</b>	1	Bushings	







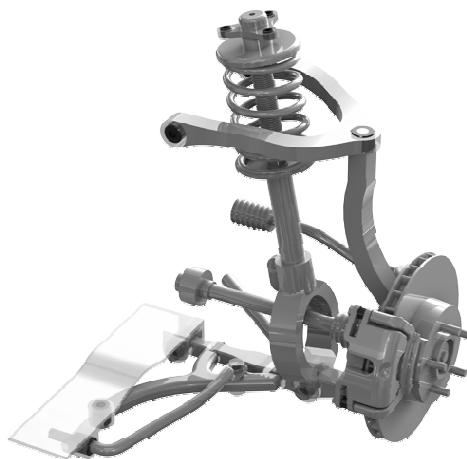
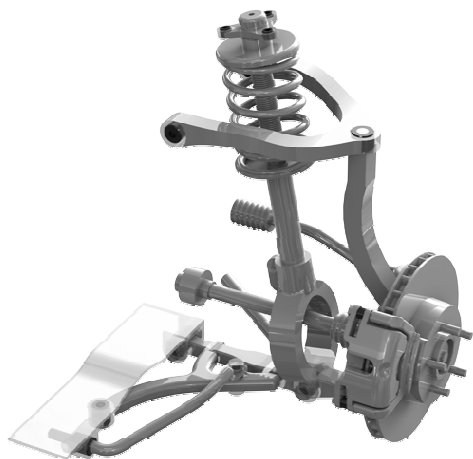

## MAZDA MX5 Convertible NC30F1 - 2005 - Current

Página 1









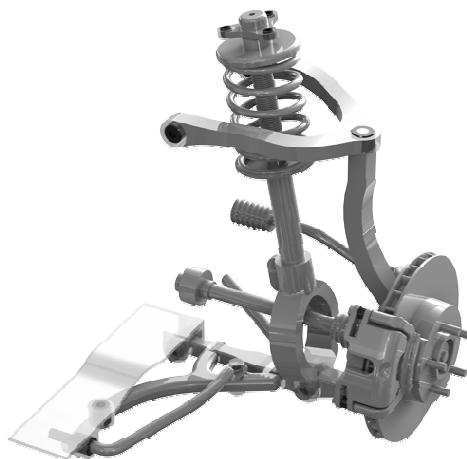
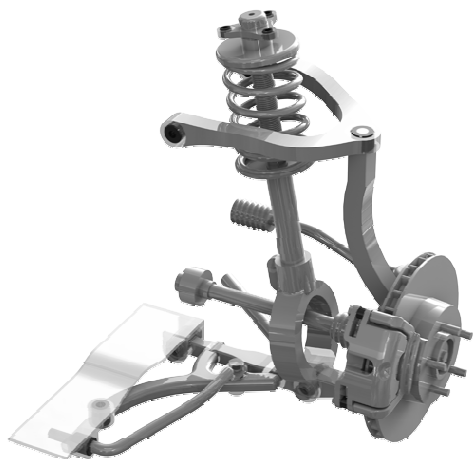

Aplicaci...	Descripción	Referencia	Kits por...	Contenido del Kit	
DEL.	Control Arm Lower-Inner Front Kit	<b>MPU-3255K</b>	1	Inner Tubes, Bushings	 SPF3255K
DEL.	Control Arm Lower-Inner Rear Eccentric 1 x Standard & 1 x offset bushing	<b>MPU-3257K</b>	1	Inst Sheet, Outer Shells, Inner Tubes, Bushings	
DEL.	Control Arm Lower-Inner Rear Eccentric 2 x Offset bushings	<b>MPU-3258K</b>	1	Inst Sheet, Outer Shells, Inner Tubes, Bushings	
DEL.	Control Arm Lower-Inner Rear Kit Performance use only, possible drivetrain NVH	<b>MPU-3256K</b>	1	Inst Sheet, Outer Shells, Inner Tubes, Bushings	
DEL.	Control Arm Upper-Inner Eccentric Kit 4 x offset tubes for adjustment	<b>MPU-3254K</b>	1	Inst Sheet, Inner Tubes, Bushings	 SPF3254K
DEL.	Control Arm Upper-Inner Kit Standard replacement	<b>MPU-3253K</b>	1	Inst Sheet, Inner Tubes, Bushings	 SPF3253K
DEL.	Shock Absorber Lower Bushing Bushing mounted in control arm	<b>MPU-3259K</b>	1	Outer Shells, Inner Tubes, Bushings	 SPF3259K



## MAZDA MX5 Convertible NC30F1 - 2005 - Current

Página 2 (Continúa)







Aplicaci...	Descripción	Referencia	Kits por...	Contenido del Kit	
DEL.	Sway Bar Mount Bushing Measure bar diameter	<b>MPU-1319-__K</b>	1	Bushings	
TRAS.	Control Arm Lower-Inner Bushing	<b>MPU-3266K</b>	1	Inner Tubes, Bushings	
TRAS.	Control Arm-Inner Front Bushing	<b>MPU-3260K</b>	1	Inner Tubes, Bushings	
TRAS.	Differential Centre Support Bush Standard replacement	<b>MPU-3404-70K</b>	1	Inner Tubes, Bushings	
TRAS.	Differential Centre Support Bush Performance use only, possible drivetrain NVH	<b>MPU-3404-80K</b>	1	Inner Tubes, Bushings	
TRAS.	Sway Bar Mount Bushing Measure bar diameter 11,12,13,14,16 & 22mm available	<b>MPU-0722-__K</b>	1	Bushings	
TRAS.	Toe Control Arm - Inner Bushing	<b>MPU-3265K</b>	1	Inner Tubes, Bushings	

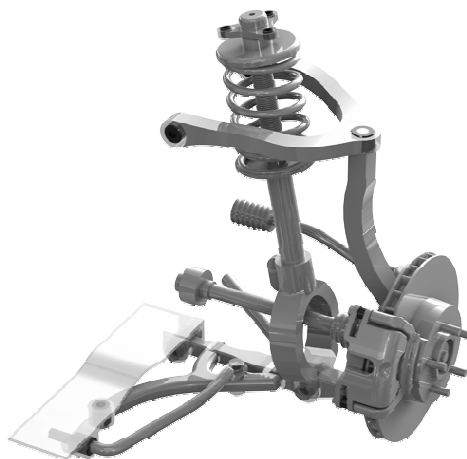
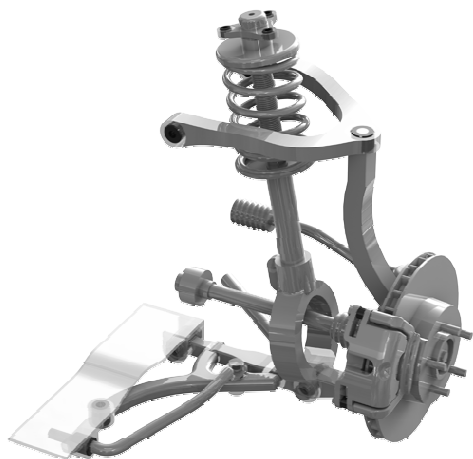

## MAZDA MX5 Convertible NC30F1 - 2005 - Current

Página 3 (Continúa)









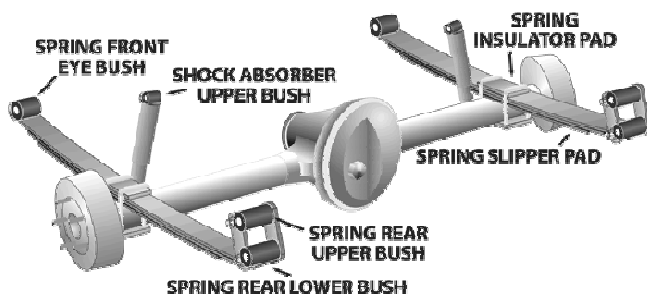
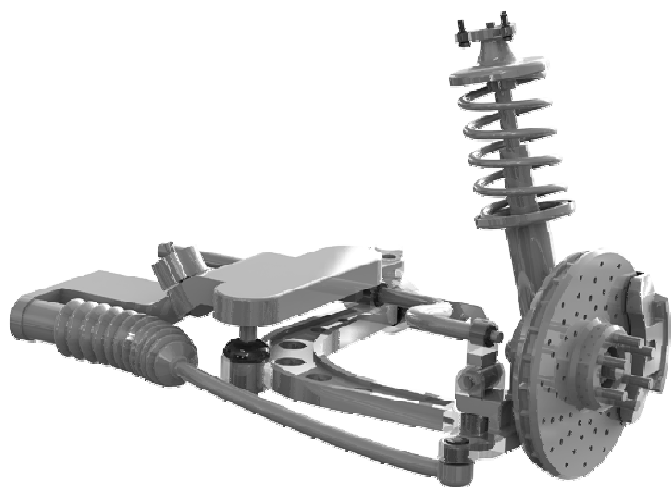

Aplicaci...	Descripción	Referencia	Kits por...	Contenido del Kit	
TRAS.	Trailing Arm Lower Bushing All Front & Rear bushings, Note- Rear bushing located in hub	<b>MPU-3264K</b>	1	Inner Tubes, Bushings	 SPF3264K
TRAS.	Trailing Arm Upper Front Bushing	<b>MPU-3260K</b>	1	Inner Tubes, Bushings	



MAZDA R100, 1200 & 1300 Sedan & Coupe - 11/1968 - 1972

Página 1







Aplicaci...	Descripción	Referencia	Kits por...	Contenido del Kit	
DEL.	Control Arm Lower-Inner Bushing 31mm OD bush, 16mm OD bolt	MPU-1661K	1	Bushings, Inner Tubes	
DEL.	Strut Bar To Chassis Mount Kit	MPU-0927K	1	Bushings	
DEL.	Strut Bar To Lower Control Arm Kit	MPU-0186K	1	Bushings	
DEL.	Sway Bar Link Bushing Kit	MPU-2092BK	1	Bushings	
DEL.	Sway Bar Mount To Chassis Bushing Measure bar diameter 14,16,18,20,21,23,24,25.4mm ava	MPU-0738-__K	1	Bushings	
TRAS.	Spring Front Eye Bushing 40mm OD bushing, 6mm wide flange	MPU-0037K	1	Bushings	
TRAS.	Spring Front Eye Bushing 40mm Diameter, 10mm wide flanges	MPU-0542K	1	Bushings	

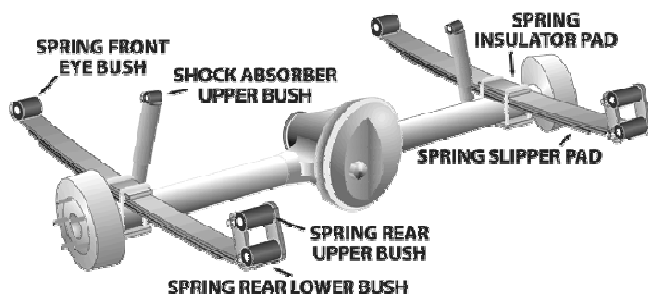
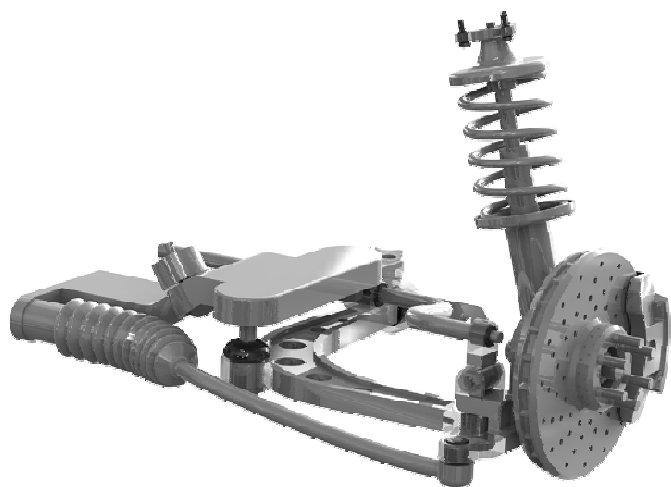

**MAZDA R100, 1200 & 1300 Sedan & Coupe - 11/1968 - 1972**

Página 2 (Continúa)



Aplicaci...	Descripción	Referencia	Kits por...	Contenido del Kit	
TRAS.	Spring Rear Bushing All 24mm OD bushing	<b>MPU-0039K</b>	2	Bushings	 0039K
TRAS.	Spring Rear Eye Bushing 29.5mm OD bushing	<b>MPU-0543K</b>	2	Bushings	 543K



## MAZDA RX2 & Capella Sedan & Coupe - 1970 - 1977

Página 1

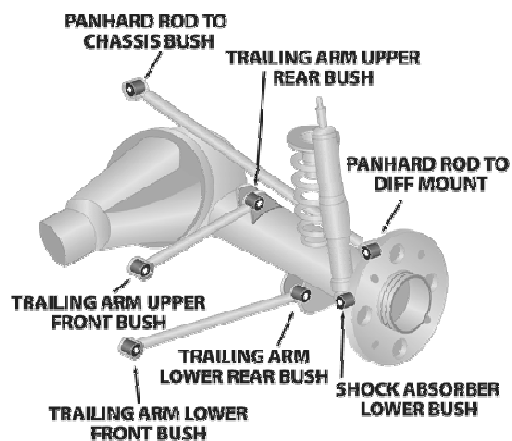
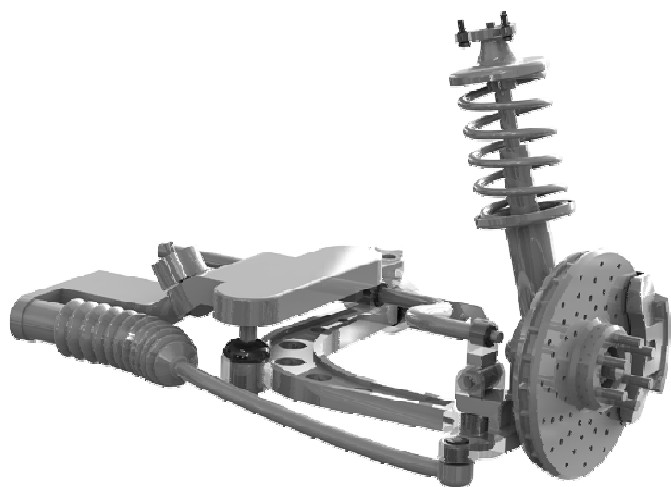

Aplicaci...	Descripción	Referencia	Kits por...	Contenido del Kit	
DEL.	Control Arm Lower-Inner Bushing RX2 only, Remove original shell for fitment	<b>MPU-0939K</b>	1	Bushings, Inner Tubes	
DEL.	Control Arm Lower-Inner Bushing 4 Cyl Capella only, "Remove OE shell for fitment"	<b>MPU-1038K</b>	1	Inner Tubes, Bushings	
DEL.	Idler Arm Bushing	<b>MPU-2002K</b>	1	Bushings	
DEL.	Steering Coupling Bushing	<b>MPU-1317K</b>	1	Inner Tubes	
DEL.	Sway Bar Mount To Chassis Bushing Measure bar diameter 19,20,21,22,23,24,27,30mm available	<b>MPU-1454-__K</b>	1	Bushings	
DEL.	Sway Bar To Lower Control Arm Kit Measure bush, 24mm length & flange diameter 47mm	<b>MPU-0161K</b>	1	Bushings	
TRAS.	Panhard Rod Bushing	<b>MPU-0011K</b>	1	Bushings, Inner Tubes	



**MAZDA RX2 & Capella Sedan & Coupe - 1970 - 1977**

Página 2 (Continúa)

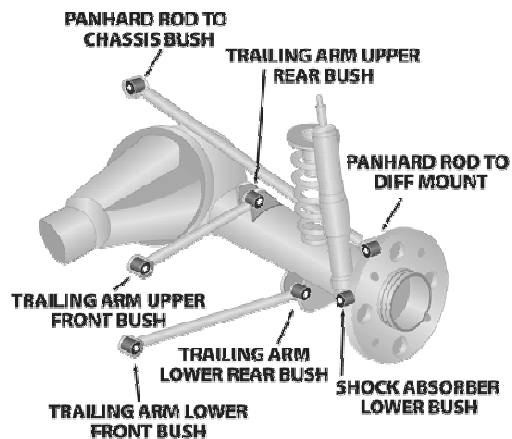
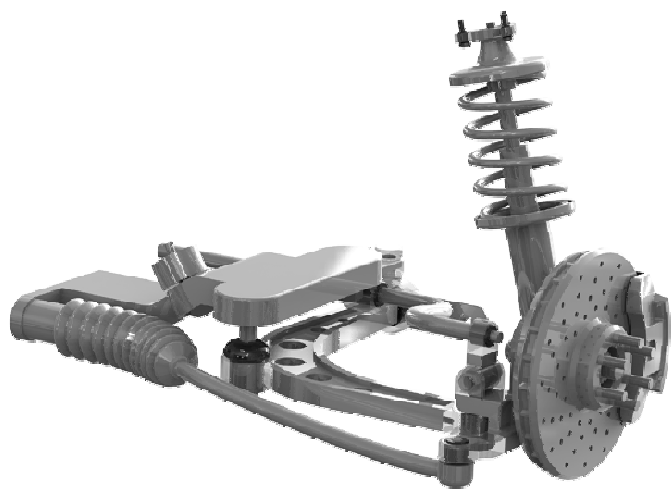

Aplicaci...	Descripción	Referencia	Kits por...	Contenido del Kit	
TRAS.	Trailing Arm Lower Bushing All	<b>MPU-0940K</b>	2	Inner Tubes, Bushings	
TRAS.	Trailing Arm Upper Bushing All	<b>MPU-0940K</b>	2	Inner Tubes, Bushings	



**MAZDA RX3 & 808 Sedan & Coupe - 1972 - 1976**

Página 1

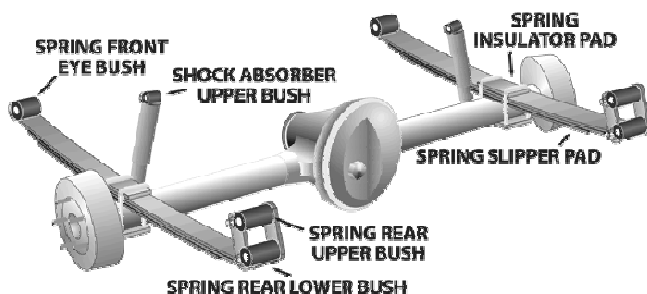
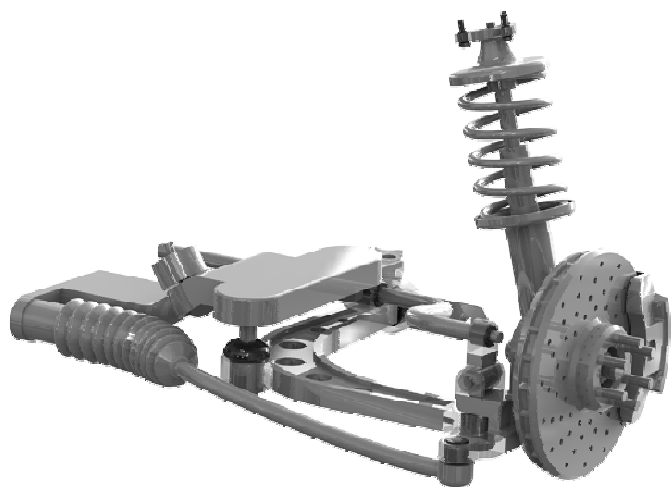

Aplicaci...	Descripción	Referencia	Kits por...	Contenido del Kit	
DEL.	Control Arm Lower-Inner Bushing	<b>MPU-0314K</b>	1	Bushings, Inner Tubes	
DEL.	Idler Arm Bushing	<b>MPU-1003K</b>	1	Bushings	
DEL.	Sway Bar Mount To Chassis Bushing Measure bar diameter 19,20,21,22,23,24,27,30mm available	<b>MPU-1454-__K</b>	1	Bushings	
DEL.	Sway Bar To Lower Control Arm Kit Measure bush, 24mm length & flange diameter 47mm	<b>MPU-0161K</b>	1	Bushings	
TRAS.	Spring Front Eye Bushing 40mm OD bushing, 6mm wide flange.	<b>MPU-0037K</b>	1	Bushings	
TRAS.	Spring Front Eye Bushing 35mm OD	<b>MPU-0038K</b>	1	Bushings	
TRAS.	Spring Rear Eye Bushing 24mm OD bushing	<b>MPU-0039K</b>	1	Bushings	





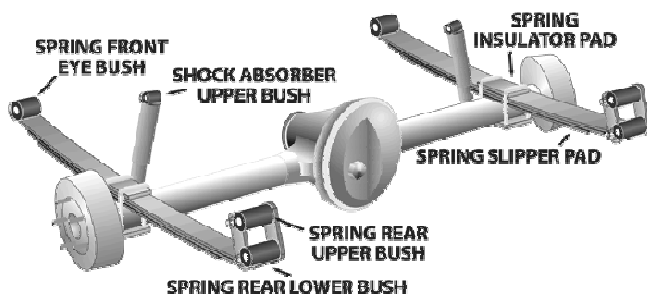
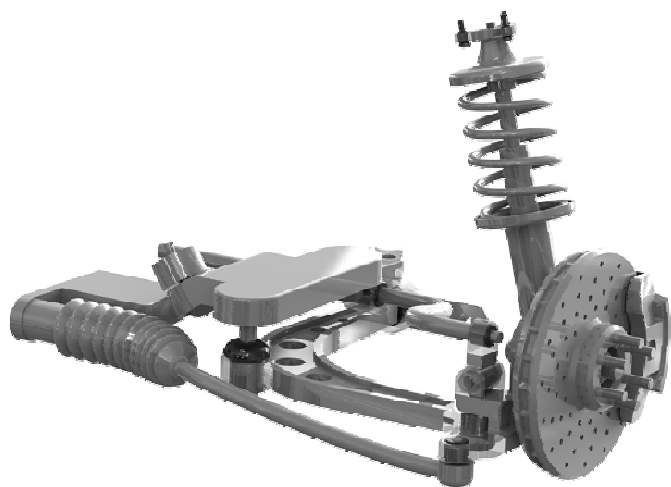

**MAZDA RX3 & 808 Sedan & Coupe - 1972 - 1976**

Página 2 (Continúa)









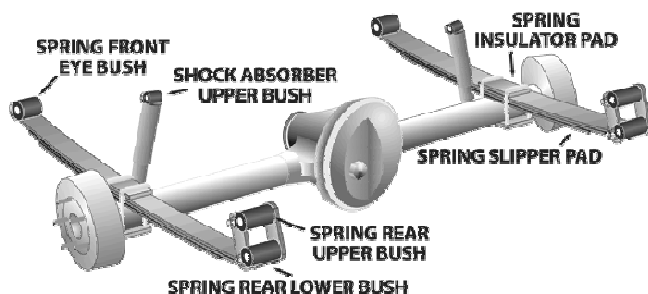
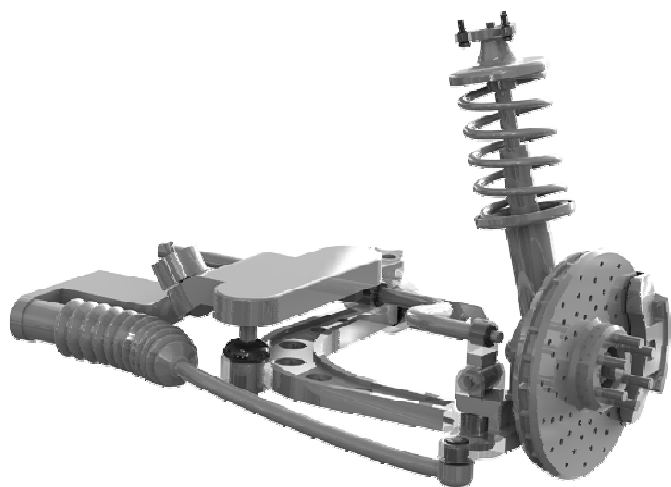

Aplicaci...	Descripción	Referencia	Kits por...	Contenido del Kit	
TRAS.	Spring Shackle Upper Bushing	MPU-0040K	1	Bushings	 0040K



## MAZDA RX4 Sedan & Coupe - 1973 - 1979

Página 1









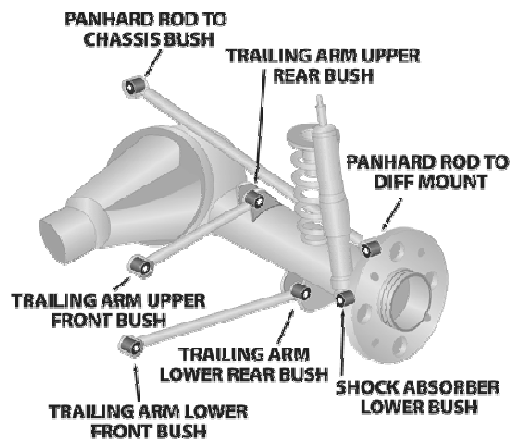
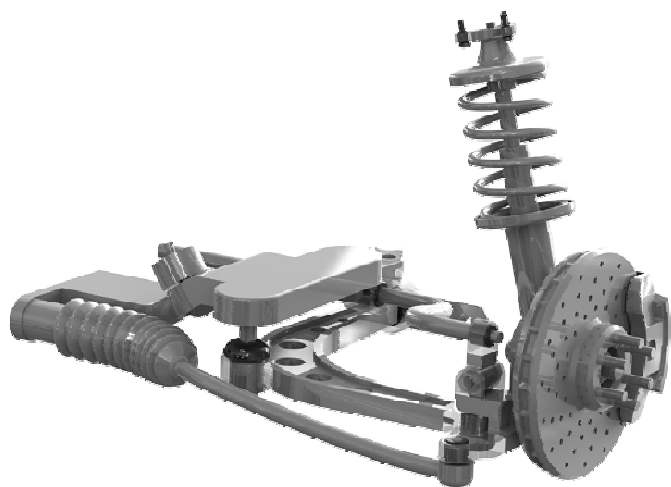

Aplicaci...	Descripción	Referencia	Kits por...	Contenido del Kit	
DEL.	Sway Bar Mount To Chassis Bushing Measure bar diameter 19,20,21,22,23,24,27,30mm available	<b>MPU-1454-__K</b>	1	Bushings	
DEL.	Control Arm Lower-Inner Bushing	<b>MPU-0595K</b>	1	Bushings, Inner Tubes	
DEL.	Idler Arm Bushing	<b>MPU-1003K</b>	1	Bushings	
DEL.	Sway Bar To Lower Control Arm Kit Measure bush, 24mm length & flange diameter 47mm	<b>MPU-0161K</b>	1	Bushings	
TRAS.	Spring Front Eye Bushing 40mm OD bushing, 10mm wide flanges.	<b>MPU-0542K</b>	1	Bushings	
TRAS.	Spring Rear Eye Bushing 29.5mm OD bushing	<b>MPU-0543K</b>	1	Bushings	
TRAS.	Spring Shackle Upper Bushing	<b>MPU-0544K</b>	1	Bushings	



## MAZDA RX5 Sedan & Coupe - 3/1976 - 1978

Página 1









Aplicaci...	Descripción	Referencia	Kits por...	Contenido del Kit	
DEL.	Idler Arm Bushing	<b>MPU-2002K</b>	1	Bushings	
DEL.	Sway Bar Link Bushing Kit	<b>MPU-2092BK</b>	1	Bushings	 SPF2092BK
DEL.	Sway Bar Mount To Chassis Bushing Measure bar diameter 14 to 27mm available	<b>MPU-1452-__K</b>	1	Bushings	
TRAS.	Panhard Rod To Chassis Mount Kit	<b>MPU-1095K</b>	1	Inner Tubes, Bushings	 1 0 9 5 K
TRAS.	Panhard Rod To Diff Mount Bushing	<b>MPU-1096K</b>	1	Bushings, Inner Tubes	 1 0 9 6 K
TRAS.	Shock Absorber Lower Bushing	<b>MPU-2178-16K</b>	1	Bushings	 SPF2178- K
TRAS.	Shock Absorber Upper Bushing	<b>MPU-2755SK</b>	1	Bushings	 SPF2755SK

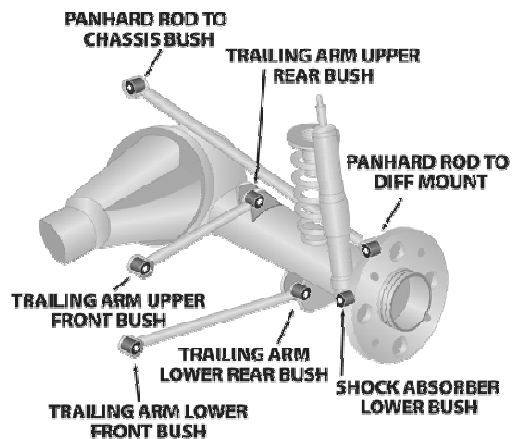
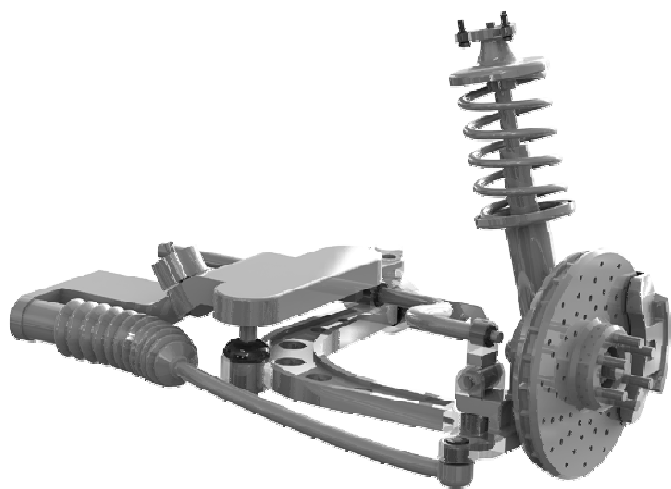

**MAZDA RX5 Sedan & Coupe - 3/1976 - 1978**

Página 2 (Continúa)









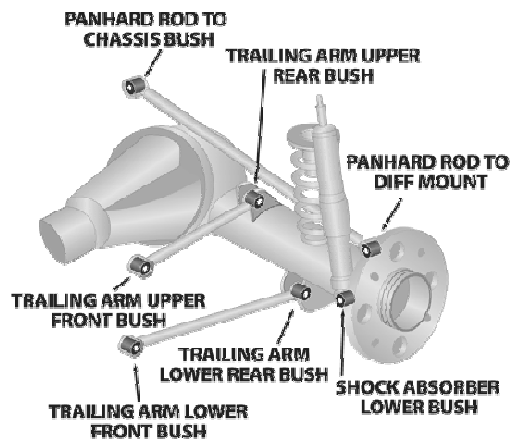
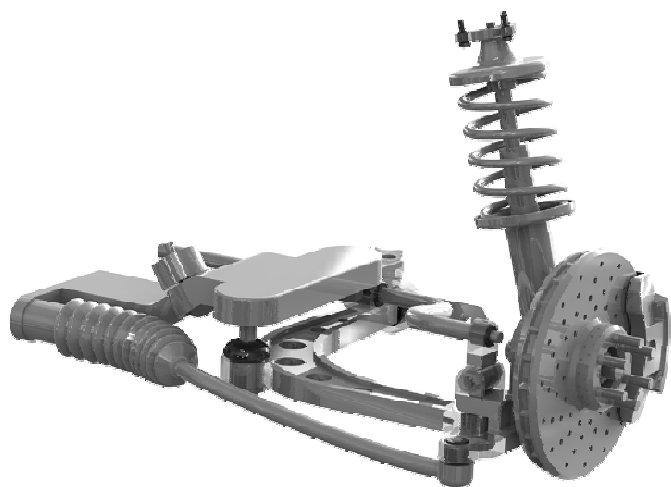

Aplicaci...	Descripción	Referencia	Kits por...	Contenido del Kit	
TRAS.	Trailing Arm Lower Front Bushing	<b>MPU-0436K</b>	1	Bushings, Inner Tubes	
TRAS.	Trailing Arm Lower Rear Bushing	<b>MPU-0437K</b>	1	Inner Tubes, Bushings	
TRAS.	Trailing Arm Upper Front Bushing	<b>MPU-0435K</b>	1	Bushings, Inner Tubes	
TRAS.	Trailing Arm Upper Rear Bushing	<b>MPU-0434K</b>	1	Inner Tubes, Bushings	



## MAZDA RX7 Series I, II, III - 1979 - 1/1986

Página 1



Aplicaci...	Descripción	Referencia	Kits por...	Contenido del Kit	
DEL.	Control Arm Lower-Inner Bushing	<b>MPU-0433K</b>	1	Bushings, Inner Tubes	
DEL.	Idler Arm Bushing	<b>MPU-1003K</b>	1	Bushings	
DEL.	Strut Bar To Chassis Mount Kit	<b>MPU-0318K</b>	1	Inner Tubes, Bushings	
DEL.	Sway Bar Link Bushing Kit	<b>MPU-2092BK</b>	1	Bushings	
DEL.	Sway Bar Mount To Chassis Bushing Measure bar diameter 12mm to 30mm available	<b>MPU-1450-__K</b>	1	Bushings	
TRAS.	Watts Link Bushing Kit Must use original crush tube	<b>MPU-0010K</b>	1	Inner Tubes, Bushings	
TRAS.	Sway Bar Link Bushing Kit	<b>MPU-0903K</b>	1	Bushings	



## MAZDA RX7 Series I, II, III - 1979 - 1/1986

Página 2 (Continúa)

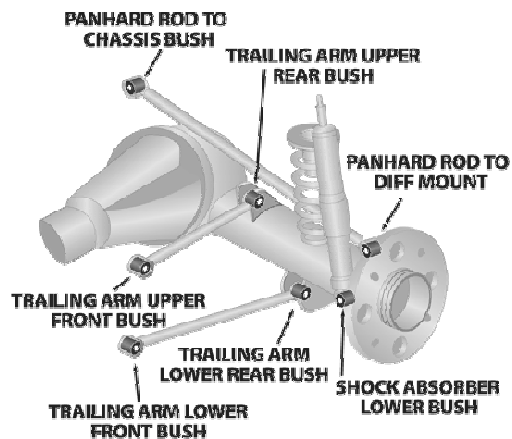
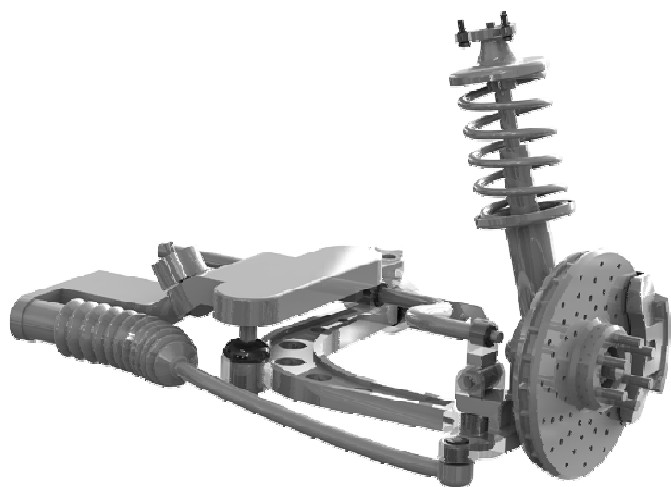







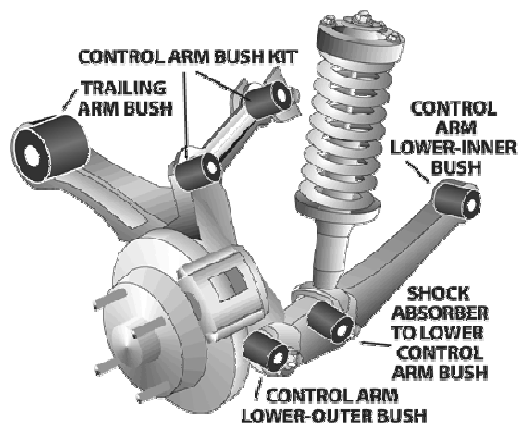
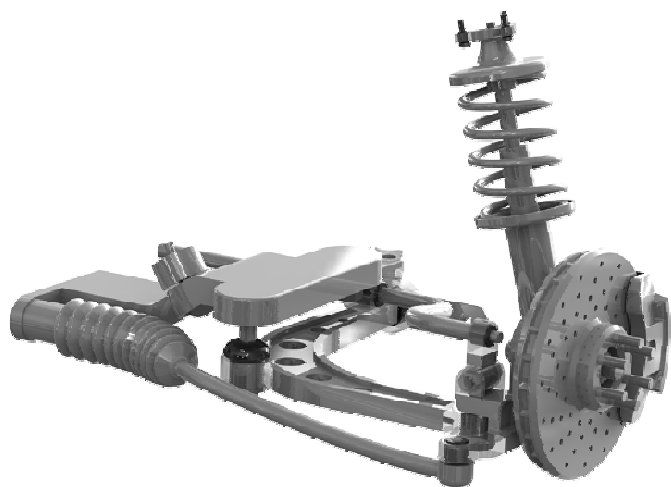

Aplicaci...	Descripción	Referencia	Kits por...	Contenido del Kit	
TRAS.	Sway Bar Mount To Axle Bushing Measure bar diameter 14,16,18,20,21,23,24,25.4mm ava	MPU-0738-__K	1	Bushings	
TRAS.	Trailing Arm Lower Bushing All	MPU-0940K	2	Inner Tubes, Bushings	
TRAS.	Trailing Arm Upper Bushing All	MPU-0940K	2	Inner Tubes, Bushings	



MAZDA RX7 Series VI,VII,VIII ( FD1031 ) - 4/1992 - 2002

Página 1



Aplicaci...	Descripción	Referencia	Kits por...	Contenido del Kit	
DEL.	Control Arm Lower-Inner Front Kit OE# FD01-34-460B	<b>MPU-2822K</b>	1	Inner Tubes, Bushings	 SPF2822K
DEL.	Control Arm Lower-Inner Front.....Eccentric 7.5mm Offset tubes for adjustment, Competition use only	<b>MPU-2822XK</b>	1	Inner Tubes, Bushings	
DEL.	Control Arm Lower-Inner Rear Eccentric 7.5mm Offset tubes for adjustment, Competition use only	<b>MPU-2823XK</b>	1	Inner Tubes, Bushings	
DEL.	Control Arm Lower-Inner Rear Kit OE# FD01-34-470A	<b>MPU-2823K</b>	1	Inner Tubes, Bushings	
DEL.	Control Arm Upper-Inner Eccentric Kit 4.5mm Offset tubes for adjustment, Competition use only	<b>MPU-2821XK</b>	1	Inner Tubes, Bushings	
DEL.	Control Arm Upper-Inner Kit Standard replacement OE# F131-34-480A	<b>MPU-2821K</b>	1	Inner Tubes, Bushings	
DEL.	Steering Rack & Pinion Mount Bush.....Power Steering OE# FD01-32-123 OE# FD01-32-124	<b>MPU-2370K</b>	1	Bushings	



**MAZDA RX7 Series VI,VII,VIII ( FD1031 ) - 4/1992 - 2002**

Página 2 (Continúa)

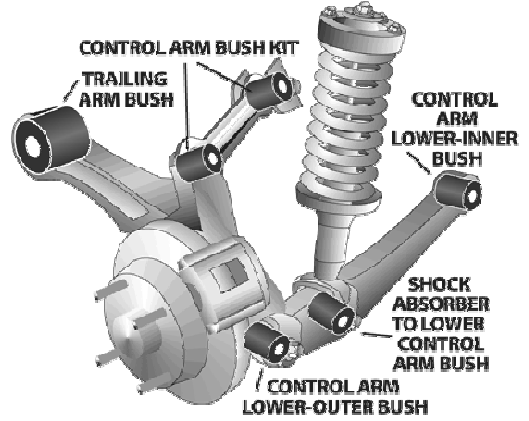
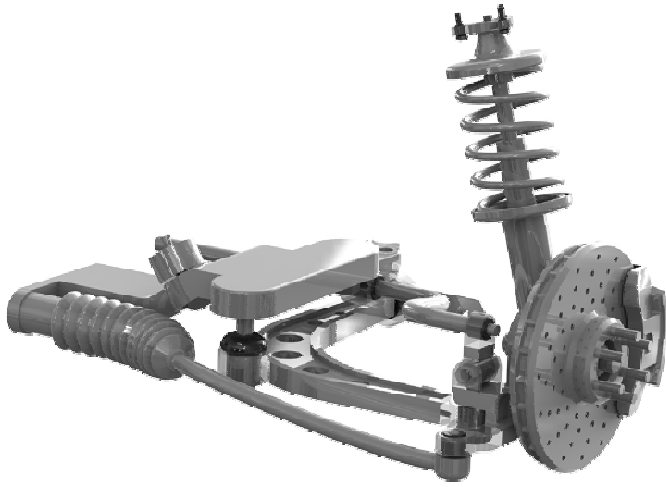

Aplicaci...	Descripción	Referencia	Kits por...	Contenido del Kit	
DEL.	Sway Bar Mount Bushing Measure bar diameter 28mm & 28.7mm available	<b>MPU-2819-__K</b>	1	Bushings	
F & R	SuperPro Alignment Kit SPF2821Kx1, SPF2822Kx1, SPF2823Kx1 SPF2370x1, SPF2679Kx1, SPF2674Kx1, SPF2675Kx1, SPF2676Kx1, SPF2677Kx1. See any notes...	<b>MPK-130ADJK</b>	1	Outer Shells, Inner Tubes, Bushings	
F & R	SuperPro Enhancement Kit SPF2821Kx1, SPF2822Kx1, SPF2823Kx1 SPF2370x1, SPF2678Kx1, SPF2674Kx1, SPF2675Kx1, SPF2676Kx1, SPF2677Kx1, SPF2680Kx1. See any notes listed against individual part numbers...	<b>MPK-130K</b>	1	Outer Shells, Inner Tubes, Bushings	
TRAS.	Sway Bar Mount Bushing Measure bar diameter 14,16,17,18,19 & 21mm available.	<b>MPU-2535-__K</b>	1	Bushings	
TRAS.	Control Arm Upper-Inner Eccentric Kit Offset tubes in kit for camber adjustment	<b>MPU-2679K</b>	1	Inner Tubes, Bushings	
TRAS.	Control Arm Upper-Inner Kit OE# FD01-28-8C0A	<b>MPU-2678K</b>	1	Inner Tubes, Bushings	 SPF2678K









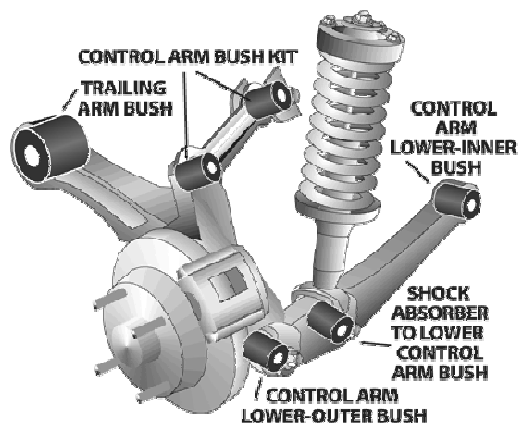
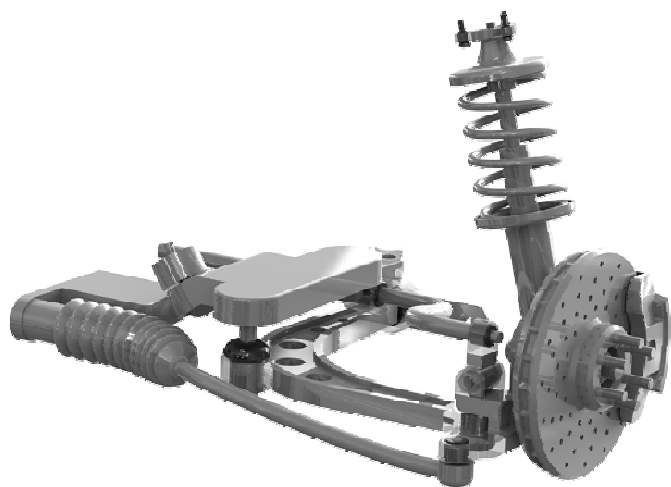

## MAZDA RX7 Series VI,VII,VIII ( FD1031 ) - 4/1992 - 2002

Página 3 (Continúa)



Aplicaci...	Descripción	Referencia	Kits por...	Contenido del Kit	
TRAS.	Differential To Cross-member Kit OE# FD01-28-890A	<b>MPU-2674K</b>	1	Inner Tubes, Bushings	
TRAS.	Shock Absorber Lower Bushing Bush located in upper control arm OE# FD01-28-710A	<b>MPU-2680K</b>	1	Inner Tubes, Bushings	
TRAS.	Toe Control Arm - Inner Bushing OE# FD01-28-42Y	<b>MPU-2675K</b>	1	Inner Tubes, Bushings	
TRAS.	Toe Control Arm - Outer Bushing OE# FD01-26-230	<b>MPU-2676K</b>	1	Inner Tubes, Bushings	
TRAS.	Trailing Arm Front To Cross-Member OE# FD15-28-50X	<b>MPU-2677K</b>	1	Outer Shells, Inner Tubes, Bushings	



**MAZDA B1500/ B1600/ B1800 / B2000 2WD - 9/1971 - 6/1985**

Página 1

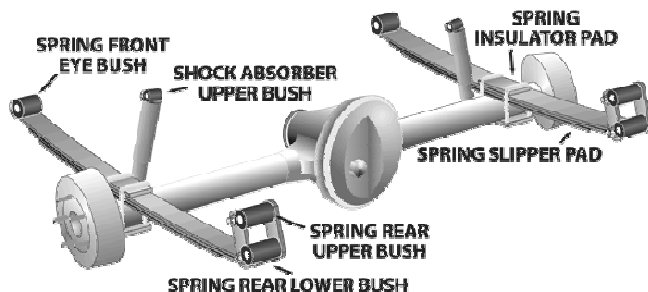
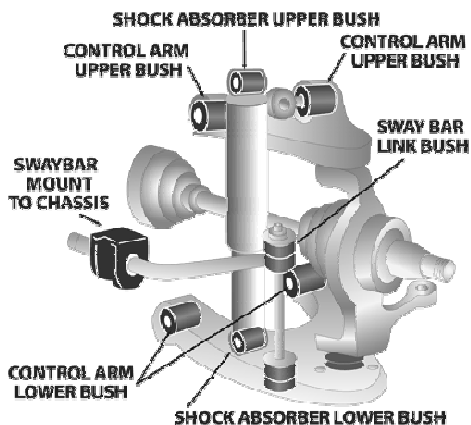







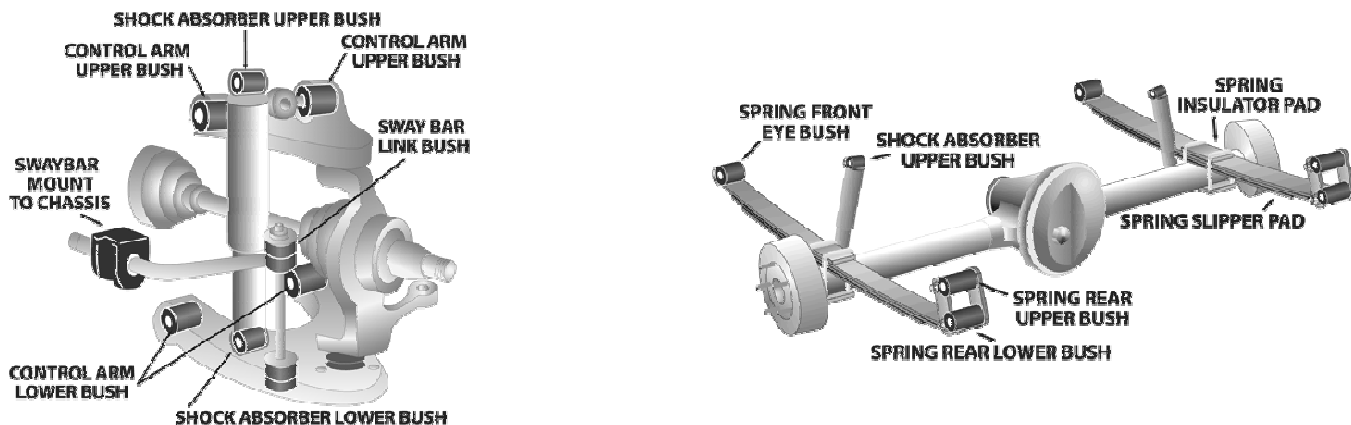

Aplicaci...	Descripción	Referencia	Kits por...	Contenido del Kit	
DEL.	Sway Bar Link Bushing Kit	<b>MPU-2092BK</b>	1	Bushings	 SPF2092BK
TRAS.	Leaf Spring Bushing All	<b>MPU-0311K</b>	3	Inner Tubes, Bushings	 0311K
TRAS.	Shock Absorber Upper / Lower Bushing	<b>MPU-2755SK</b>	1	Bushings	 SPF2755SK
TRAS.	Shock Absorber Upper / Lower Bushing	<b>MPU-2937K</b>	2	Bushings	 2937K



## MAZDA Bravo / Proceed 2WD & 4WD - 1/1999 - 2006

Página 1





Aplicaci...	Descripción	Referencia	Kits por...	Contenido del Kit	
DEL.	Sway Bar Mount To Chassis Bushing 2WD Measure bar diameter 14mm to 27mm available	MPU-0605-__K	1	Bushings	
DEL.	Control Arm Upper-Inner Kit 2WD & 4WD Replaces OE# UH71-34-470	MPU-2510K	1	Outer Shells, Inner Tubes, Bushings	 SPF2510K
DEL.	Strut Bar To Chassis Mount Kit 2WD	MPU-0998K	1	Bushings, Inner Tubes	 0998K
DEL.	Sway Bar Mount Bushing 4WD Measure bar diameter 19,20,21,22,23,26mm available	MPU-0202-__K	1	Bushings	
TRAS.	Leaf Spring Bushing All SPF0311K x 1,SPF0502K x 1,SPF0753K x 1	MPK-065K	1		
TRAS.	Spring Front Eye Bushing	MPU-0311K	1	Inner Tubes, Bushings	 0311K
TRAS.	Spring Rear Eye Bushing	MPU-0502K	1	Bushings	 SPF0502K

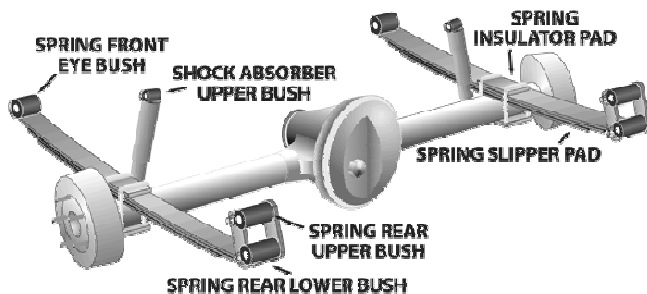
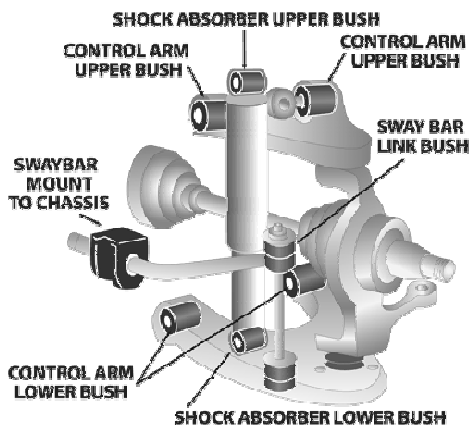

**MAZDA Bravo / Proceed 2WD & 4WD - 1/1999 - 2006**

Página 2 (Continúa)



Aplicaci...	Descripción	Referencia	Kits por...	Contenido del Kit	
TRAS.	Spring Shackle Upper Bushing	MPU-0753K	1	Bushings	



## MAZDA Bravo / Proceed 2WD & 4WD - 1985 - 1999

Página 1

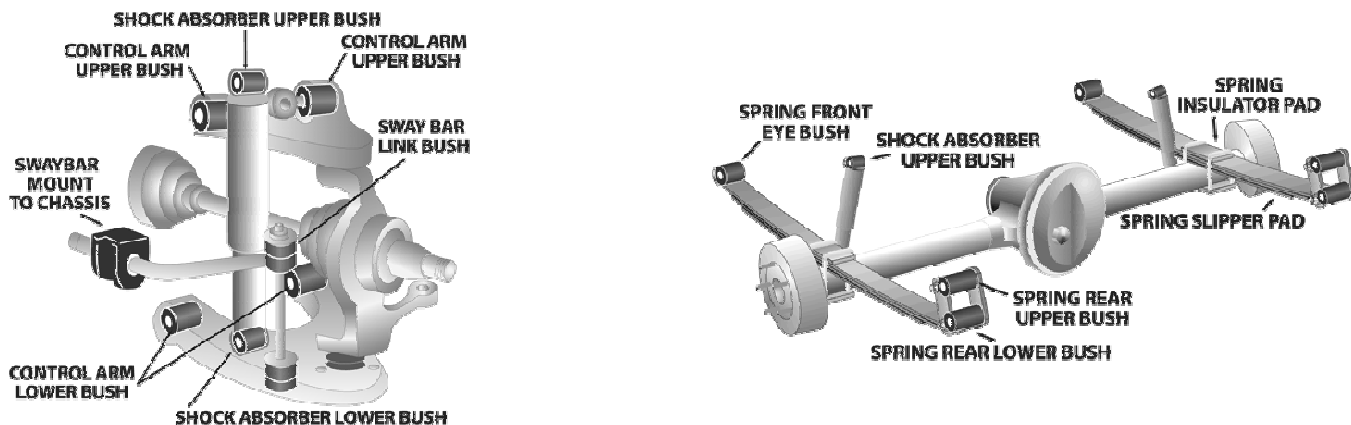

Aplicaci...	Descripción	Referencia	Kits por...	Contenido del Kit	
DEL.	Idler Arm Bushing	MPU-1076K	1	Bushings	
DEL.	Shock Absorber Upper Bushing	MPU-0094K	1	Bushings	
DEL.	Strut Bar To Chassis Mount Kit 2WD	MPU-0998K	1	Bushings, Inner Tubes	
DEL.	Sway Bar Link Bushing Kit	MPU-2092BK	1	Bushings	
DEL.	Sway Bar Mount To Chassis Bushing Measure bar diameter 14 to 27mm available	MPU-0605-__K	1	Bushings	
TRAS.	Leaf Spring Bushing All SPF0311K x 1,SPF0502K x 1,SPF0753K x 1	MPK-065K	1		
TRAS.	Shock Absorber Upper / Lower Bushing 2WD	MPU-2178-16K	2	Bushings	



## MAZDA Bravo / Proceed 2WD & 4WD - 1985 - 1999

Página 2 (Continúa)

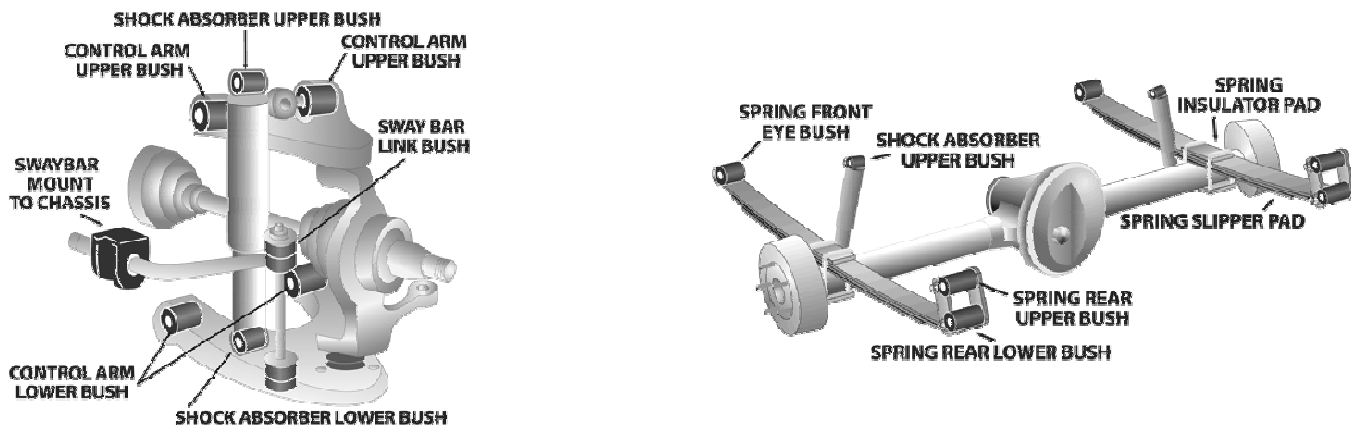

Aplicaci...	Descripción	Referencia	Kits por...	Contenido del Kit	
TRAS.	Spring Front Eye Bushing	MPU-0311K	1	Inner Tubes, Bushings	 0311K
TRAS.	Spring Rear Eye Bushing 32mm OD bush, 18mm ID	MPU-0502K	1	Bushings	 SPF0502K
TRAS.	Spring Shackle Upper Bushing 4WD & 2WD	MPU-0753K	1	Bushings	 SPF0753K



**MAZDA E Series Van E1300, E1400, E1600 - 5/1978 - 12/1983**

Página 1

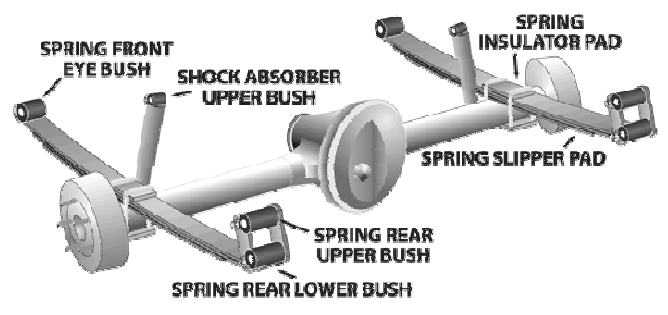
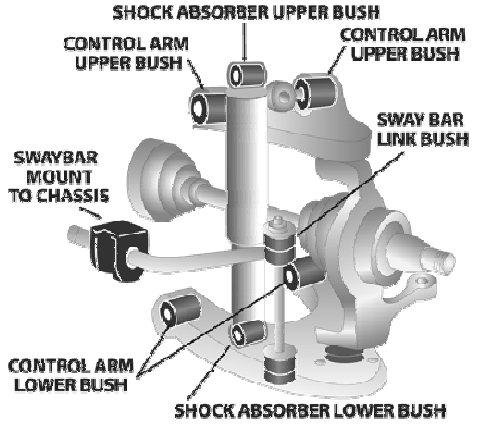

Aplicaci...	Descripción	Referencia	Kits por...	Contenido del Kit	
DEL.	Shock Absorber Upper Bushing	<b>MPU-0094K</b>	1	Bushings	
DEL.	Sway Bar Link To Chassis Bushing	<b>MPU-0903-4K</b>	1	Bushings	
TRAS.	Spring Front Eye Bushing 1981 to 12/1983	<b>MPU-0502K</b>	1	Bushings	
TRAS.	Shock Absorber Upper / Lower Bushing	<b>MPU-2178-16K</b>	2	Bushings	
TRAS.	Spring Front Eye Bushing 5/1978 - 1980	<b>MPU-0311K</b>	1	Inner Tubes, Bushings	
TRAS.	Spring Rear Bushing All 5/1978 - 1980	<b>MPU-0311K</b>	2	Inner Tubes, Bushings	
TRAS.	Spring Rear Bushing All 1981 to 12/1983	<b>MPU-0502K</b>	2	Bushings	



**MAZDA E Series Van E1800, E2000, E2200 - 2/1984 - 2003**

Página 1

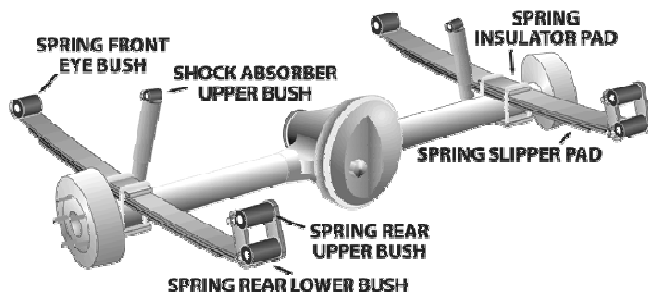
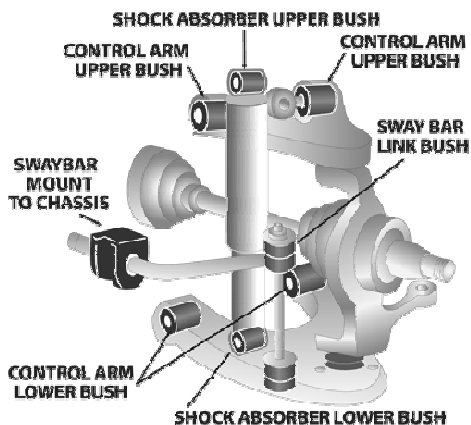

Aplicaci...	Descripción	Referencia	Kits por...	Contenido del Kit	
DEL.	Control Arm Lower-Inner Bushing Must re-use original shell	<b>MPU-2160K</b>	1	Inner Tubes, Bushings	
DEL.	Control Arm Upper-Inner Kit	<b>MPU-2122K</b>	1	Washers, Inner Tubes, Bushings	
DEL.	Shock Absorber Upper Bushing	<b>MPU-0094K</b>	1	Bushings	
DEL.	Strut Bar To Chassis Mount Kit	<b>MPU-2153K</b>	1	Inner Tubes, Bushings	
DEL.	Sway Bar Link Bushing Kit	<b>MPU-0306K</b>	1	Bushings	
DEL.	Sway Bar Mount To Chassis Bushing Measure bar diameter 18,20,22 & 24mm available	<b>MPU-1149-__K</b>	1	Bushings	
TRAS.	Shock Absorber Upper / Lower Bushing	<b>MPU-2178-16K</b>	2	Bushings	





**MAZDA E Series Van E1800, E2000, E2200 - 2/1984 - 2003**

Página 2 (Continúa)

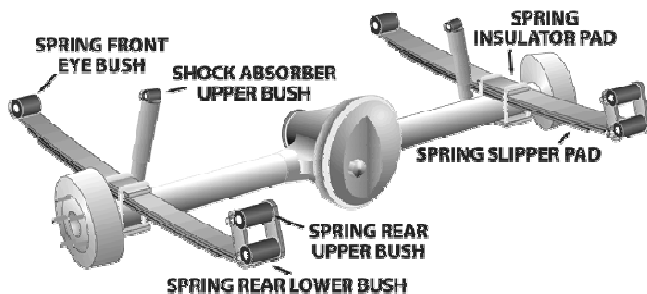
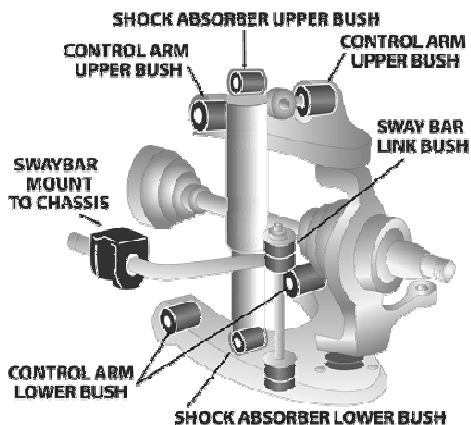







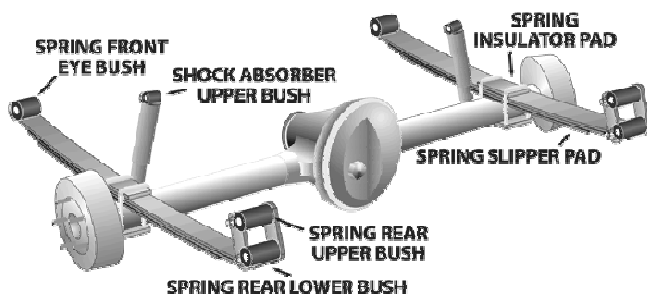
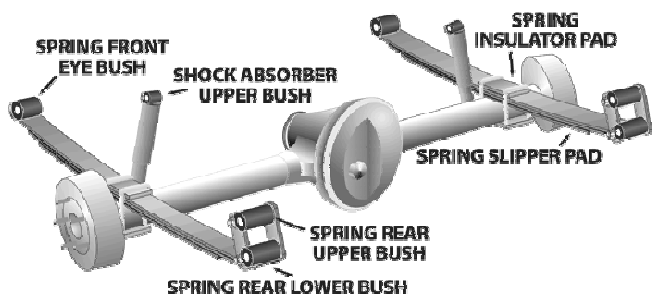

Aplicaci...	Descripción	Referencia	Kits por...	Contenido del Kit	
TRAS.	Spring Front Eye Bushing 40mm OD 20mm ID	<b>MPU-0878K</b>	1	Bushings	
TRAS.	Spring Front Eye Bushing 32mm OD 17mm ID	<b>MPU-0889K</b>	1	Bushings	
TRAS.	Spring Rear Bushing All	<b>MPU-0888-4K</b>	2	Bushings	



**MAZDA T3000, T3500, TITAN BUS & 4WD, T40 - 1981 - On**

Página 1



Aplicaci...	Descripción	Referencia	Kits por...	Contenido del Kit	
DEL.	Shock Absorber Upper Bushing	<b>MPU-2755SK</b>	1	Bushings	
DEL.	Shock Absorber Lower Bushing	<b>MPU-2178-16K</b>	1	Bushings	
DEL.	Spring Front Eye Bushing	<b>MPU-0371K</b>	1	Inner Tubes, Bushings	
DEL.	Spring Rear Bushing All	<b>MPU-0370K</b>	2	Bushings, Inner Tubes	
TRAS.	Shock Absorber Upper / Lower Bushing	<b>MPU-2178-16K</b>	2	Bushings	
TRAS.	Spring Front Eye Bushing	<b>MPU-0371K</b>	1	Inner Tubes, Bushings	
TRAS.	Spring Rear Bushing All	<b>MPU-0370K</b>	2	Bushings, Inner Tubes	



## MITSUBISHI Sigma & Scorpion GE, GH - 10/1977 - 2/1982

Página 1

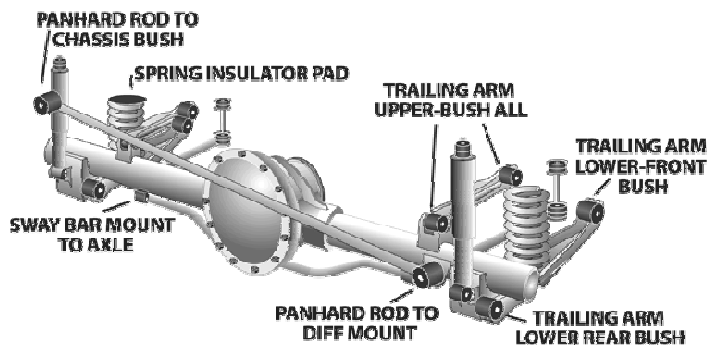
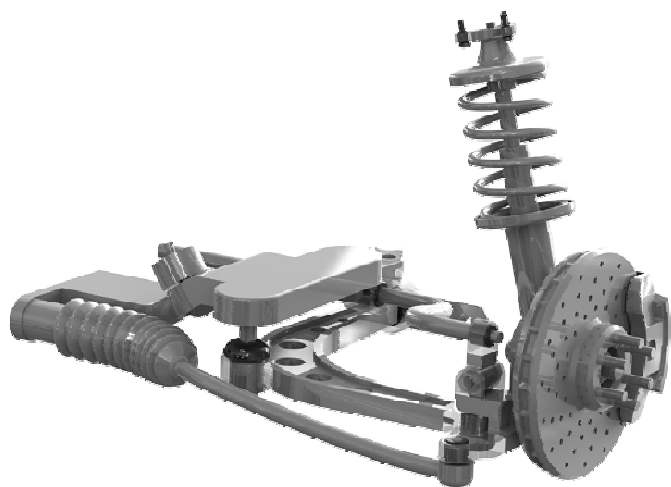

Aplicaci...	Descripción	Referencia	Kits por...	Contenido del Kit	
DEL.	Strut Bar To Chassis Mount Kit	<b>MPU-0184K</b>	1	Bushings	
DEL.	Control Arm Lower-Inner Bushing OE# MB 001621 ( Tapered bush )	<b>MPU-0154K</b>	1	Bushings	
DEL.	Control Arm Lower-Inner Bushing Recessed body shoulder "Re-use original shell"	<b>MPU-0594K</b>	1	Bushings, Inner Tubes	
DEL.	Control Arm Lower-Inner Bushing Tapered two half pieces	<b>MPU-0954K</b>	1	Bushings	
DEL.	Control Arm Lower-Inner Bushing OE# MB109786(Raised body shoulder)"Re-use original shell"	<b>MPU-1109K</b>	1	Bushings, Inner Tubes	
DEL.	Idler Arm Bushing Tapered style bush	<b>MPU-0602K</b>	1	Bushings	
DEL.	Sway Bar Link Bushing Kit	<b>MPU-2092BK</b>	1	Bushings	



## MITSUBISHI Sigma & Scorpion GE, GH - 10/1977 - 2/1982

Página 2 (Continúa)

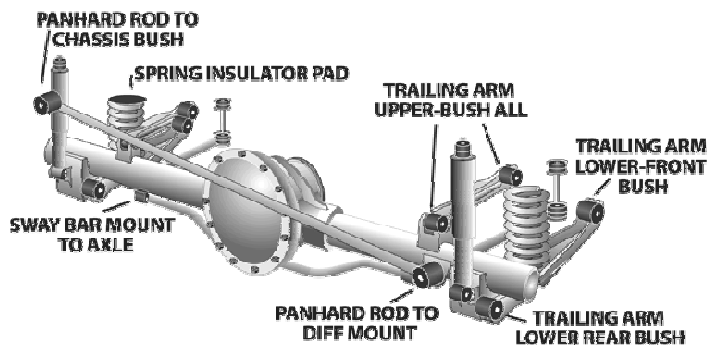
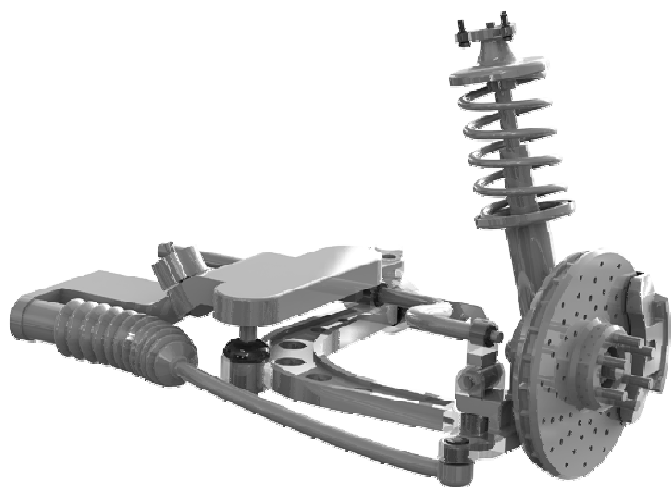



Aplicaci...	Descripción	Referencia	Kits por...	Contenido del Kit	
DEL.	Sway Bar Mount To Chassis Bushing Measure bar diameter 14,15,16,21,22,24,26,30mm now available	MPU-1138-__K	1	Bushings	
DEL.	Sway Bar Mount To Chassis Bushing Only suits 35mm original bracket height,see picture above,please supply bar size	MPU-1450-__K	1	Bushings	
TRAS.	Trailing Arm Lower Diagonal Support	MPU-0425K	1	Inner Tubes, Bushings	
TRAS.	Trailing Arm Lower Front Bushing Bush OD 57mm, tube length 60mm	MPU-0166K	1	Bushings, Inner Tubes	
TRAS.	Trailing Arm Lower Rear Bushing Bush OD 45mm, tube length 60mm	MPU-0168K	1	Inner Tubes, Bushings	
TRAS.	Trailing Arm Upper Bushing All Bush OD 45mm, tube length 60mm (Normally Scorpion).	MPU-0168K	2	Inner Tubes, Bushings	
TRAS.	Trailing Arm Upper Front Bushing Cotton reel style,bush OD48.5mm, tube length 45mm	MPU-0593K	1	Inner Tubes, Bushings	

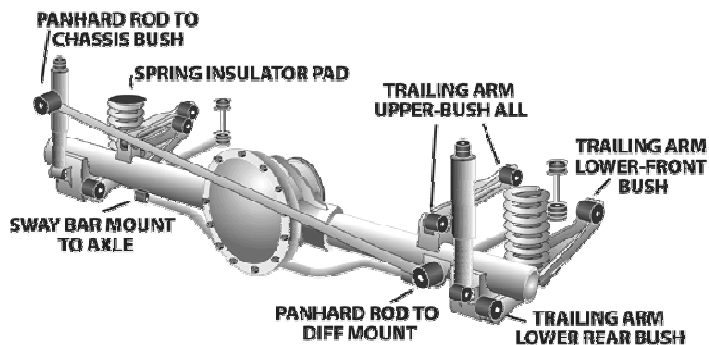
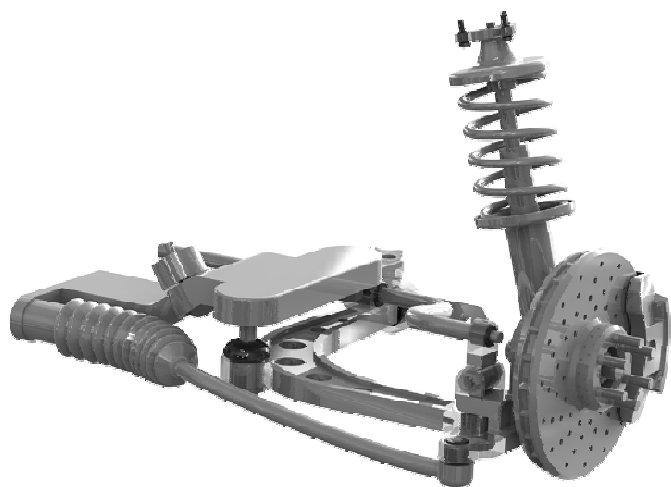

**MITSUBISHI Sigma & Scorpion GE, GH - 10/1977 - 2/1982**

Página 3 (Continúa)



Aplicaci...	Descripción	Referencia	Kits por...	Contenido del Kit	
TRAS.	Trailing Arm Upper Rear Bushing Shackle style, bush OD 48.5mm, tube length 45mm	<b>MPU-0592K</b>	1	Bushings, Inner Tubes	

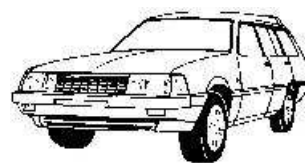

## MITSUBISHI Sigma & Scorpion GJ, GK, GN - 3/1982 - 8/1987

Página 1

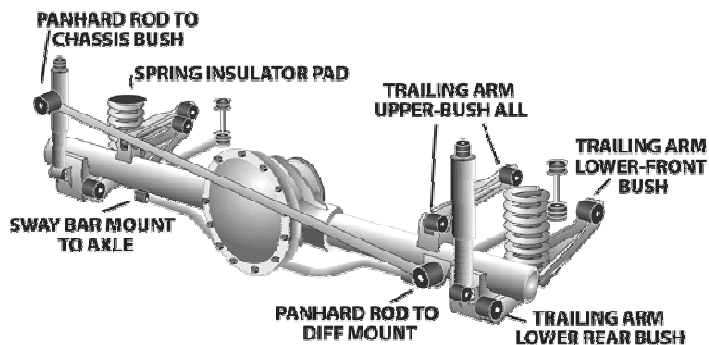
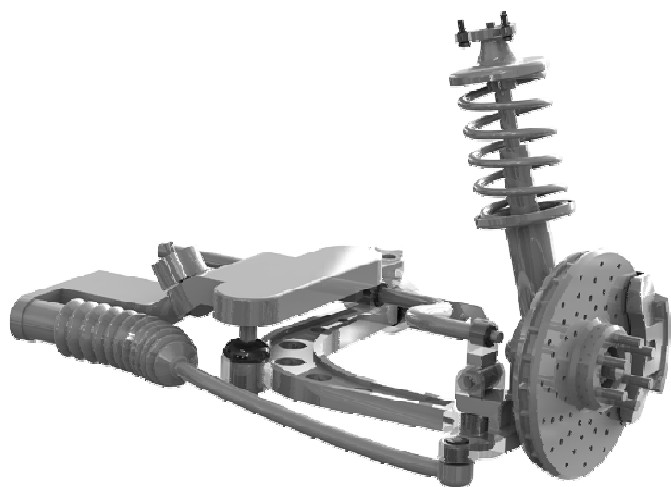

Aplicaci...	Descripción	Referencia	Kits por...	Contenido del Kit	
DEL.	Control Arm Lower-Inner Bushing Recessed body shoulder "Re-use original shell"	<b>MPU-0594K</b>	1	Bushings, Inner Tubes	
DEL.	Control Arm Lower-Inner Bushing OE# MB109786(Raised body shoulder)"Re-use original shell"	<b>MPU-1109K</b>	1	Bushings, Inner Tubes	
DEL.	Idler Arm Bushing Tapered style bush	<b>MPU-0602K</b>	1	Bushings	
DEL.	Strut Bar To Chassis Mount Kit	<b>MPU-0184K</b>	1	Bushings	
DEL.	Sway Bar Link Bushing Kit	<b>MPU-2092BK</b>	1	Bushings	
DEL.	Sway Bar Mount To Chassis Bushing Measure bar diameter 14,15,16,21,22,24,26,30mm now available	<b>MPU-1138-__K</b>	1	Bushings	
DEL.	Sway Bar Mount To Chassis Bushing Only suits 35mm original bracket height,see picture above,please supply bar size	<b>MPU-1450-__K</b>	1	Bushings	



## MITSUBISHI Sigma & Scorpion GJ, GK, GN - 3/1982 - 8/1987

Página 2 (Continúa)

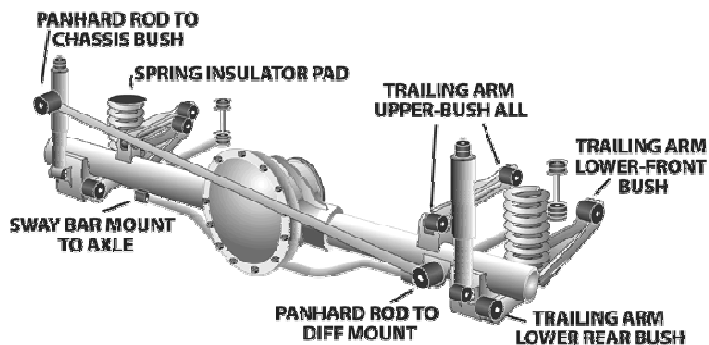
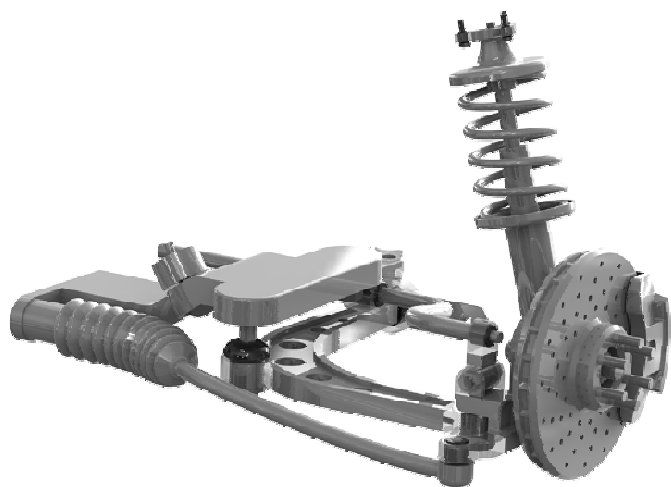



Aplicaci...	Descripción	Referencia	Kits por...	Contenido del Kit	
TRAS.	Trailing Arm Lower Rear Bushing Cotton reel style, bush OD 45mm, tube length 50mm	<b>MPU-0424K</b>	1	Bushings, Inner Tubes	
TRAS.	Trailing Arm Lower Diagonal Support	<b>MPU-0425K</b>	1	Inner Tubes, Bushings	
TRAS.	Trailing Arm Lower Front Bushing Bush OD 57mm, tube length 60mm	<b>MPU-0166K</b>	1	Bushings, Inner Tubes	
TRAS.	Trailing Arm Lower Front Bushing Cotton reel style, bush OD 56mm, tube length 60mm	<b>MPU-0423K</b>	1	Inner Tubes, Bushings	
TRAS.	Trailing Arm Lower Rear Bushing Bush OD 45mm, tube length 60mm	<b>MPU-0168K</b>	1	Inner Tubes, Bushings	
TRAS.	Trailing Arm Upper Bushing All Bush OD 45mm, tube length 60mm (Normally Scorpion)	<b>MPU-0168K</b>	2	Inner Tubes, Bushings	
TRAS.	Trailing Arm Upper Front Bushing Cotton reel style, bush OD 48.5mm tube length 45mm	<b>MPU-0593K</b>	1	Inner Tubes, Bushings	

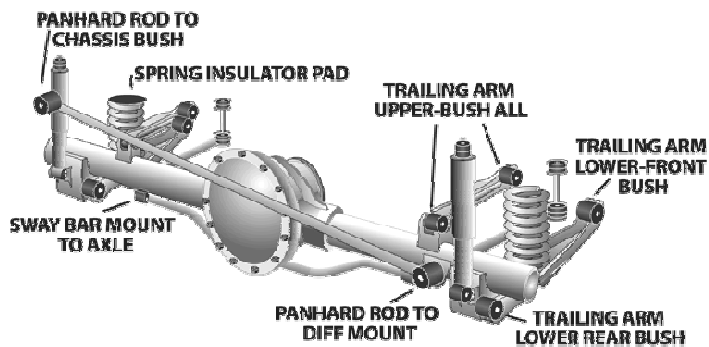
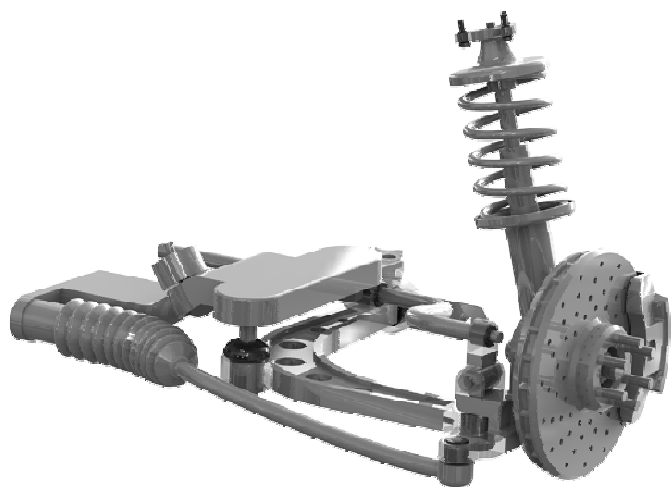

**MITSUBISHI Sigma & Scorpion GJ, GK, GN - 3/1982 - 8/1987**

Página 3 (Continúa)



Aplicaci...	Descripción	Referencia	Kits por...	Contenido del Kit	
TRAS.	Trailing Arm Upper Rear Bushing Shackle style, bush OD 48.5mm, tube length 45mm	<b>MPU-0592K</b>	1	Bushings, Inner Tubes	







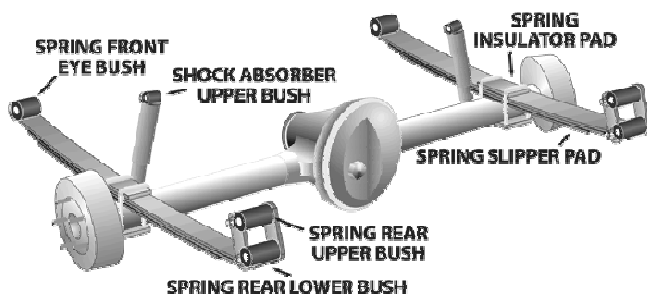
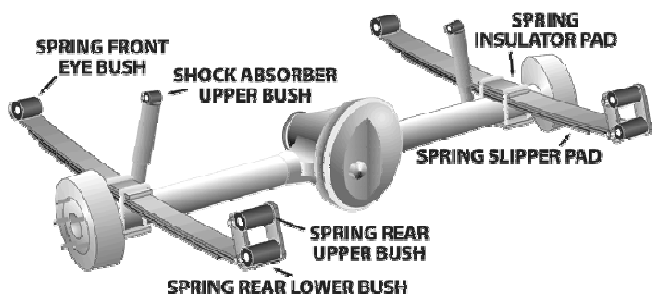

**MITSUBISHI Canter FC, FD, FE - 1979 - 2004**

Página 1









Aplicaci...	Descripción	Referencia	Kits por...	Contenido del Kit	
DEL.	Leaf Spring Bushing All Must measure shackle pin size 21,22 & 23mm available	<b>MPU-0816-_ _HK</b>	1	Bushings	
DEL.	Shock Absorber Lower Bushing	<b>MPU-2178-16K</b>	1	Bushings	
DEL.	Shock Absorber Upper Bushing	<b>MPU-2755LK</b>	1	Bushings	
TRAS.	Shock Absorber Upper / Lower Bushing	<b>MPU-2178-16K</b>	2	Bushings	

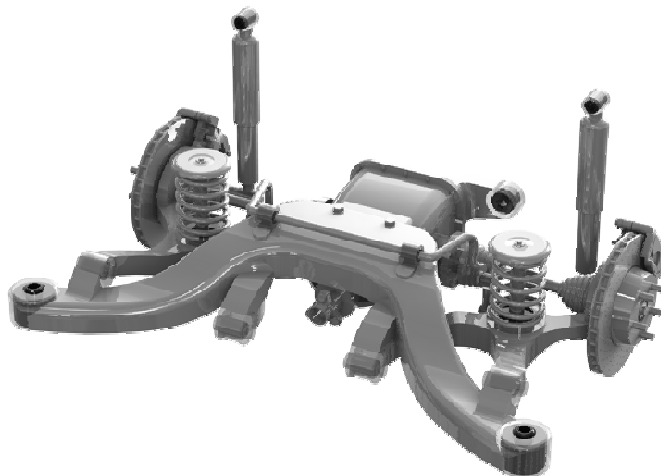
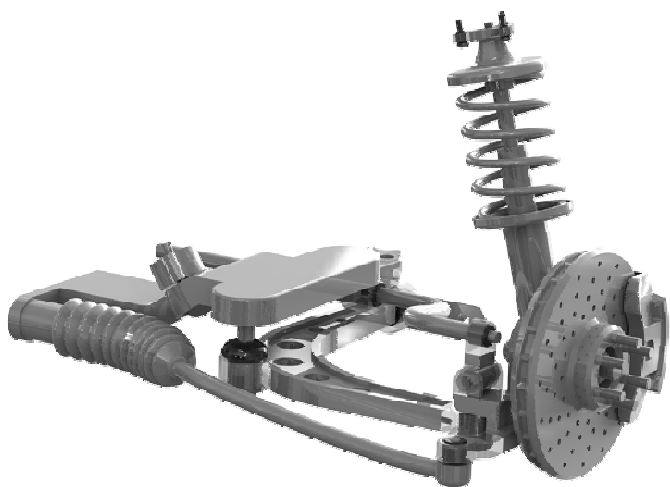

**MITSUBISHI Starion JA, JB, JD - 5/1982 - 8/1987**

Página 1







Aplicaci...	Descripción	Referencia	Kits por...	Contenido del Kit	
DEL.	Control Arm Lower-Inner Bushing	<b>MPU-1109K</b>	1	Bushings, Inner Tubes	
DEL.	Strut Bar To Chassis Mount Kit	<b>MPU-0184K</b>	1	Bushings	
DEL.	Sway Bar Link Bushing Kit	<b>MPU-2092BK</b>	1	Bushings	
DEL.	Sway Bar Mount To Chassis Bushing Measure bar diameter 21 & 24mm available	<b>MPU-1405-__K</b>	1	Bushings	

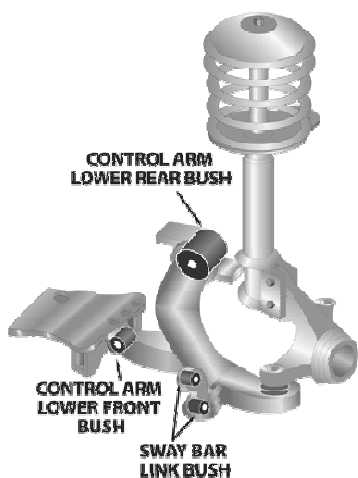

## MITSUBISHI Colt 7th Gen. - RG Series - 2002 - Current

Página 1



Aplicaci...	Descripción	Referencia	Kits por...	Contenido del Kit	
DEL.	Control Arm Lower-Inner Rear Eccentric 1 x Offset & 1 x Standard bushing.	<b>MPU-3112K</b>	1	Outer Shells, Inner Tubes, Bushings	
DEL.	Control Arm Lower-Inner Rear Eccentric 2 x Offset bushings.	<b>MPU-3113K</b>	1	Outer Shells, Inner Tubes, Bushings	
DEL.	Control Arm Lower-Inner Rear Kit Standard replacement.	<b>MPU-3111K</b>	1	Outer Shells, Inner Tubes, Bushings	



## MITSUBISHI EVO Series EVO 1, 2, 3 - 1992 - 1996

Página 1

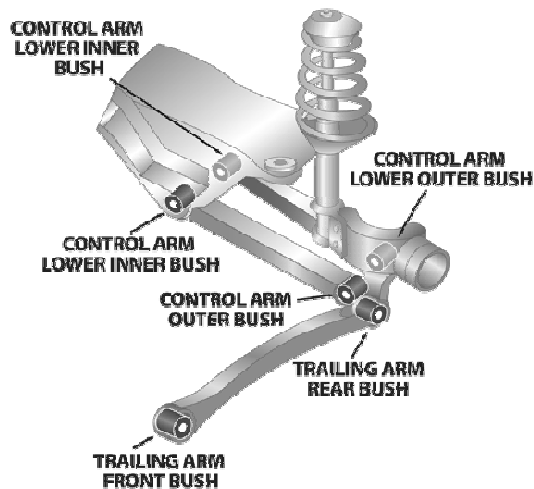
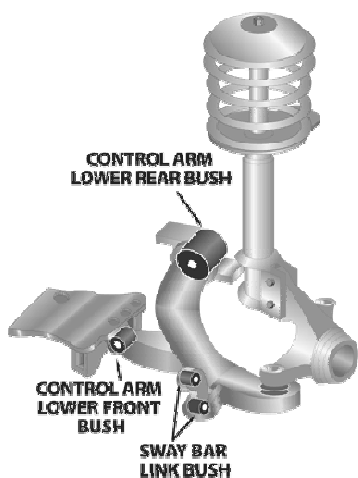







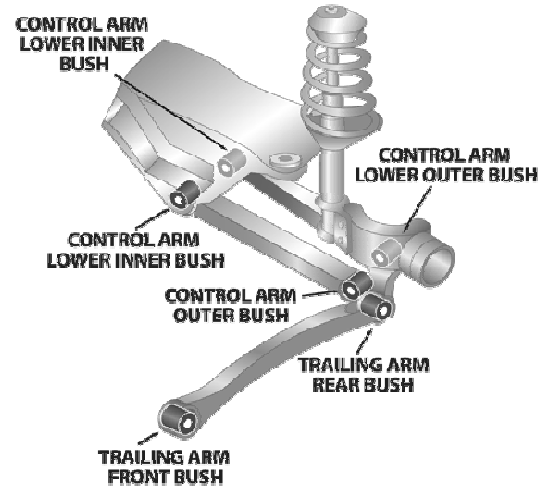
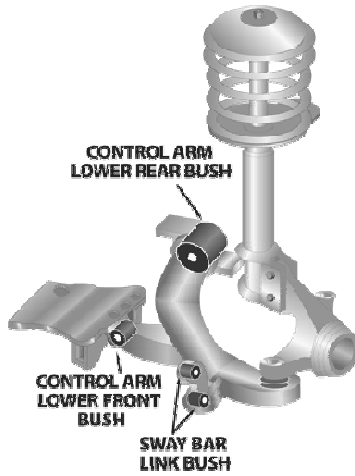

Aplicaci...	Descripción	Referencia	Kits por...	Contenido del Kit	
DEL.	Control Arm Lower-Front Bushing 12mm Mounting Bolt	<b>MPU-1715K</b>	1	Inner Tubes, Bushings	
DEL.	Control Arm Lower-Inner Front Kit 14mm Mounting bolt	<b>MPU-1715-14K</b>	1	Inner Tubes, Bushings	
DEL.	Control Arm Lower-Inner Rear Kit Standard	<b>MPU-1714K</b>	1	Bushings, Inner Tubes, Outer Shells, Washers	
DEL.	Control Arm Lower-Inner Rear Kit Single offset	<b>MPU-2025K</b>	1	Washers, Outer Shells, Inner Tubes, Bushings	
DEL.	Control Arm Lower-Inner Rear Kit Double offset	<b>MPU-2026K</b>	1	Washers, Outer Shells, Inner Tubes, Bushings	
DEL.	Sway Bar Mount To Chassis Bushing Measure bar diameter 16,18mm available	<b>MPU-1701-__K</b>	1	Bushings	
TRAS.	Control Arm Upper-Outer Bushing	<b>MPU-2291K</b>	1	Outer Shells, Inner Tubes, Bushings	



## MITSUBISHI EVO Series EVO 1, 2, 3 - 1992 - 1996

Página 2 (Continúa)









Aplicaci...	Descripción	Referencia	Kits por...	Contenido del Kit	
TRAS.	Control Arm Lower-Inner & Outer Kit	<b>MPU-1573K</b>	1	Outer Shells, Inner Tubes, Bushings	
TRAS.	Control Arm Upper-Inner Kit Kit includes mounting foot pin	<b>MPU-2110K</b>	1	Pin, Outer Shells, Bushings	
TRAS.	Differential Pinion, Bracket Mount Kit 54mm outside diameter bushing	<b>MPU-2543K</b>	1	Washers, Inner Tubes, Bushings	
TRAS.	Differential Pinion, Bracket Mount Kit Supplement washer kit	<b>MPU-2546K</b>	1	Washers, Bushings	
TRAS.	Differential Support Bracket Mount Kit Replaces OE # MB809334	<b>MPU-2544K</b>	1	Outer Shells, Inner Tubes, Bushings	
TRAS.	Lateral Arm Front Inner Bushing Replaces hyme joint type bush with 40.25mm OD bush	<b>MPU-2027K</b>	1	Inner Tubes, Bushings	
TRAS.	Lateral Arm Front Outer Bushing Kit includes mounting foot pin	<b>MPU-2110K</b>	1	Pin, Outer Shells, Bushings	

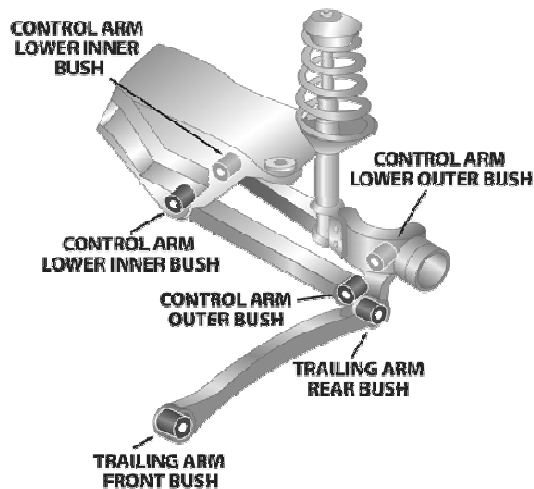
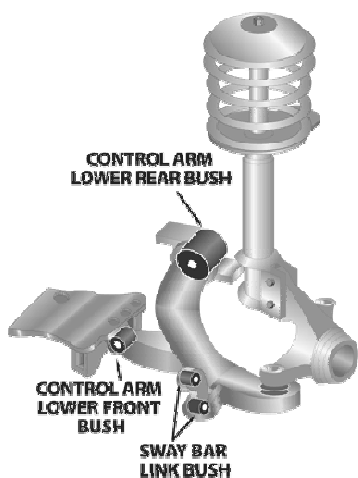

## MITSUBISHI EVO Series EVO 1, 2, 3 - 1992 - 1996

Página 3 (Continúa)









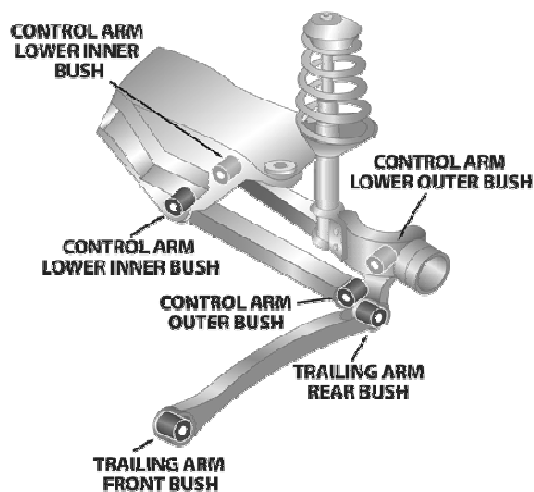

Aplicaci...	Descripción	Referencia	Kits por...	Contenido del Kit	
TRAS.	Sway Bar Link Bushing Kit	<b>MPU-2092BK</b>	1	Bushings	 SPF2092BK
TRAS.	Sway Bar Mount To Chassis Bushing Measure bar diameter 16,18mm available, 27mm wide bracket	<b>MPU-1700-__K</b>	1	Bushings	
TRAS.	Sway Bar Mount To Chassis Bushing Bar diameter 12,13,15,16,18,19,20,22mm ava,32mm wide bracket	<b>MPU-1826-__K</b>	1	Bushings	
TRAS.	Trailing Arm - Front Bushing	<b>MPU-1574K</b>	1	Inner Tubes, Bushings	 1574K



## MITSUBISHI EVO Series EVO 7, EVO 8, EVO 9 - 2001 - 2008

Página 1









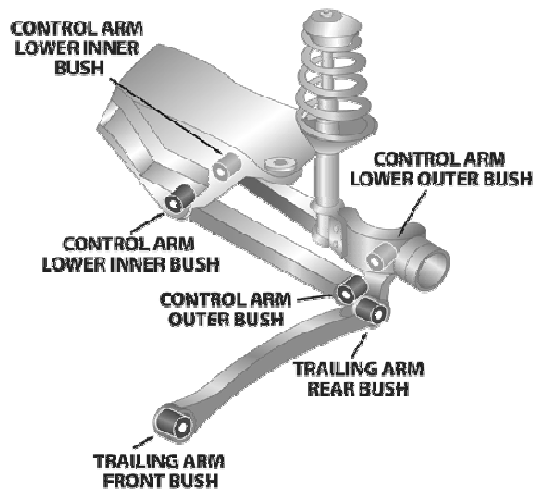

Aplicaci...	Descripción	Referencia	Kits por...	Contenido del Kit	
DEL.	Control Arm Lower-Inner Front Kit	<b>MPU-2418K</b>	1	Inner Tubes, Bushings	
DEL.	Steering Rack & Pinion Mount Bush.....Power Steering EVO 8 only "Not USA Spec Vehicle"	<b>MPU-2489K</b>	1	Inner Tubes, Bushings	
DEL.	Sway Bar Mount To Chassis Bushing Measure bar diameter, 24,25,26,27,28,29,30mm available	<b>MPU-1451-__K</b>	1	Bushings	
F & R	SuperPro Alignment Kit SPF2418Kx1,SPF2489Kx1,SPF2072Kx1,SPF2062 Kx1, SPF1974Kx1,SPF1975Kx1,SPF2544Kx1,SPF260...	<b>MPK-142K</b>	1	Outer Shells, Inner Tubes, Bushings	
TRAS.	Differential Pinion, Bracket Mount Kit 54mm outside diameter bushing.	<b>MPU-2543K</b>	1	Washers, Inner Tubes, Bushings	
TRAS.	Control Arm Lower-Shock Mount Kit	<b>MPU-2072K</b>	1	Inner Tubes, Bushings	



**MITSUBISHI EVO Series EVO 7, EVO 8, EVO 9 - 2001 - 2008**

Página 2 (Continúa)



Aplicaci...	Descripción	Referencia	Kits por...	Contenido del Kit	
TRAS.	Control Arm Upper-Inner Front Bushing	<b>MPU-2062K</b>	1	Inner Tubes, Bushings	
TRAS.	Control Arm Upper-Inner Rear Kit	<b>MPU-1974K</b>	1	Inner Tubes, Bushings	
TRAS.	Differential Pinion, Bracket Mount Kit 45mm outside diameter bushing	<b>MPU-1975K</b>	1	Inner Tubes, Bushings	
TRAS.	Differential Support Bracket Mount Kit	<b>MPU-2544K</b>	1	Outer Shells, Inner Tubes, Bushings	
TRAS.	Sway Bar Mount To Chassis Bushing Measure bar diameter 21, 22, 23.8, 24.5mm available	<b>MPU-2073-__K</b>	1	Bushings	
TRAS.	Toe Control Arm - Inner Bushing	<b>MPU-2063K</b>	1	Inner Tubes, Bushings	
TRAS.	Toe Control Arm - Inner Bushing Adjustable, Offset tubes in kit	<b>MPU-2601K</b>	1	Inner Tubes, Bushings	





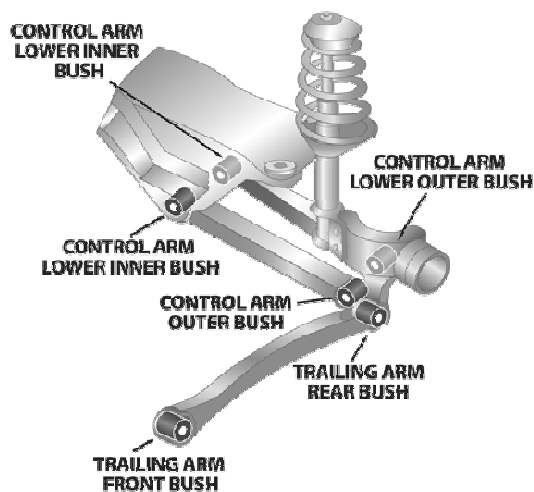

**MITSUBISHI EVO Series EVO 7, EVO 8, EVO 9 - 2001 - 2008**

Página 3 (Continúa)









Aplicaci...	Descripción	Referencia	Kits por...	Contenido del Kit	
TRAS.	Trailing Arm Lower Front Bushing	<b>MPU-1973K</b>	1	Inner Tubes, Bushings	 SPF1973K

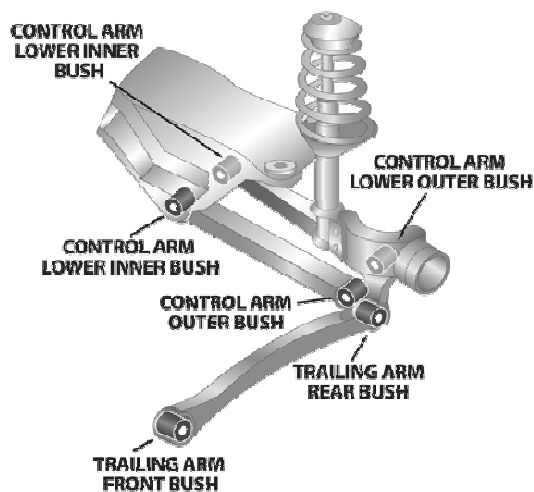

## MITSUBISHI EVO Series EVO 10 - 2007 - Current

Página 1



Aplicaci...	Descripción	Referencia	Kits por...	Contenido del Kit	
DEL.	Control Arm Lower-Inner Front Kit	<b>MPU-2418K</b>	1	Inner Tubes, Bushings	 SPF2418K
DEL.	Steering Rack & Pinion Mount Bushing	<b>MPU-3731K</b>	1	Bushings, Inner Tubes, Inst Sheet	 SPF3731K
DEL.	Sway Bar Mount To Chassis Bushing Check bar diameter, 23mm & 25mm	<b>MPU-3362-__K</b>	1	Bushings	 SPF3362- K
TRAS.	Control Arm Upper-Inner Front Bushing	<b>MPU-2418K</b>	1	Inner Tubes, Bushings	 SPF2418K
TRAS.	Sway Bar Mount To Chassis Bushing Check bar diameter, 23,25,27,27.5,28mm	<b>MPU-3362-__K</b>	1	Bushings	 SPF3362- K



MITSUBISHI EVO Series EVO 4, EVO 5, EVO 6 - 1996 - 2001

Página 1

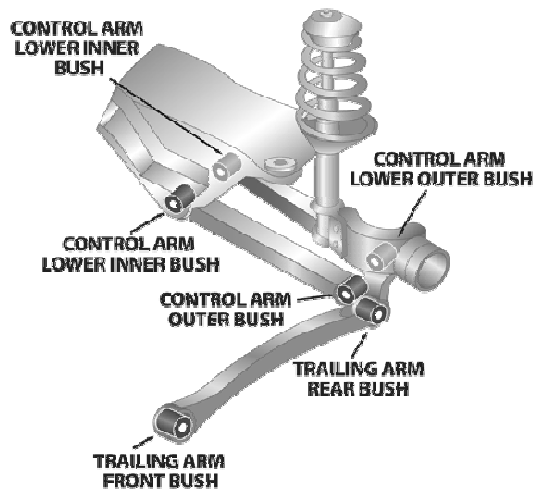
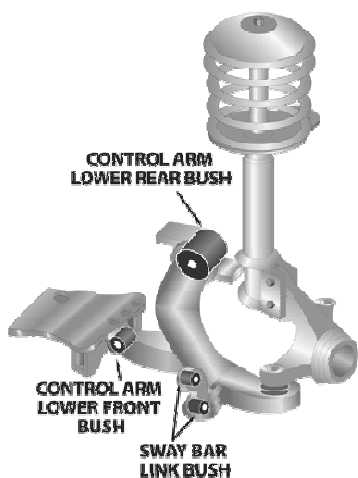







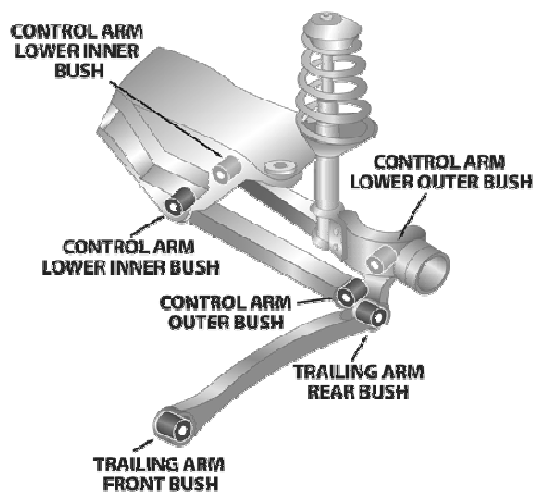
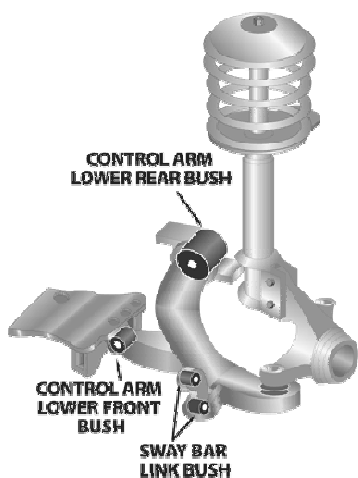

Aplicaci...	Descripción	Referencia	Kits por...	Contenido del Kit	
DEL.	Control Arm Lower-Inner Front Kit 14mm Mounting bolt	MPU-1715-14K	1	Inner Tubes, Bushings	
DEL.	Control Arm Lower-Inner Front Kit 12mm Mounting Bolt	MPU-1715K	1	Inner Tubes, Bushings	
DEL.	Control Arm Lower-Inner Rear Kit Standard	MPU-1714K	1	Bushings, Inner Tubes, Outer Shells, Washers	
DEL.	Control Arm Lower-Inner Rear Kit Single offset	MPU-2025K	1	Washers, Outer Shells, Inner Tubes, Bushings	
DEL.	Control Arm Lower-Inner Rear Kit Double offset	MPU-2026K	1	Washers, Outer Shells, Inner Tubes, Bushings	
DEL.	Sway Bar Mount To Chassis Bushing Measure bar diameter 14,16,18,20,21,23,24,25.4mm ava	MPU-0738-__K	1	Bushings	
TRAS.	Control Arm Lower-Shock Mount Kit	MPU-2072K	1	Inner Tubes, Bushings	



## MITSUBISHI EVO Series EVO 4, EVO 5, EVO 6 - 1996 - 2001

Página 2 (Continúa)





Aplicaci...	Descripción	Referencia	Kits por...	Contenido del Kit	
TRAS.	Control Arm Upper-Inner Front Bushing	<b>MPU-2062K</b>	1	Inner Tubes, Bushings	
TRAS.	Control Arm Upper-Inner Rear Kit	<b>MPU-1974K</b>	1	Inner Tubes, Bushings	
TRAS.	Differential Pinion, Bracket Mount Kit 45mm outside diameter bushing	<b>MPU-1975K</b>	1	Inner Tubes, Bushings	
TRAS.	Differential Pinion, Bracket Mount Kit 54mm outside diameter bushing.	<b>MPU-2543K</b>	1	Washers, Inner Tubes, Bushings	
TRAS.	Differential Support Bracket Mount Kit	<b>MPU-2544K</b>	1	Outer Shells, Inner Tubes, Bushings	
TRAS.	Sway Bar Mount To Chassis Bushing Measure bar diameter 21, 22, 23.8, 24.5mm available	<b>MPU-2073-__K</b>	1	Bushings	
TRAS.	Toe Control Arm - Inner Bushing	<b>MPU-2063K</b>	1	Inner Tubes, Bushings	

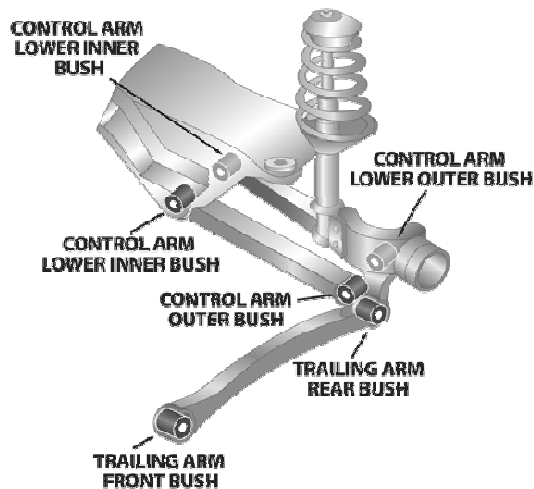
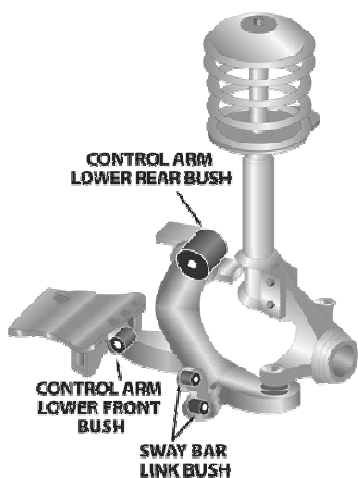

**MITSUBISHI EVO Series EVO 4, EVO 5, EVO 6 - 1996 - 2001**

Página 3 (Continúa)









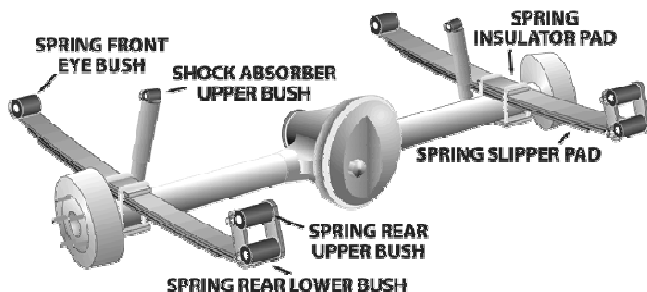
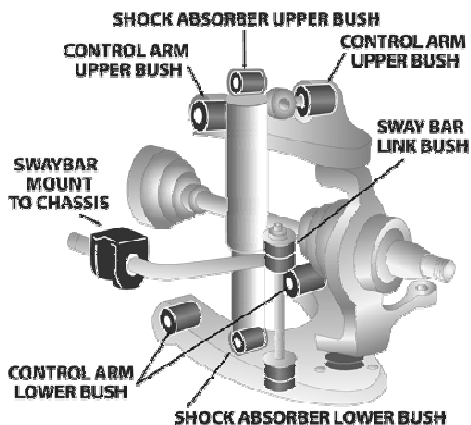

Aplicaci...	Descripción	Referencia	Kits por...	Contenido del Kit	
TRAS.	Toe Control Arm - Inner Bushing Adjustable, Offset tubes in kit	<b>MPU-2601K</b>	1	Inner Tubes, Bushings	 SPF2601K
TRAS.	Trailing Arm Lower Front Bushing	<b>MPU-1973K</b>	1	Inner Tubes, Bushings	 SPF1973K



**MITSUBISHI Express / Delica L300 / Starwagon SA - SE 2WD &...**

Página 1



Aplicaci...	Descripción	Referencia	Kits por...	Contenido del Kit	
DEL.	Strut Bar To Chassis Mount Kit	<b>MPU-0448K</b>	1	Inner Tubes, Bushings	
DEL.	Control Arm Lower-Inner Bushing 2WD Tapered style bush OD = 27.9mm to 35.7mm	<b>MPU-1152K</b>	1	Bushings	
DEL.	Control Arm Lower-Inner Bushing 34mm OD bush 2WD	<b>MPU-1208K</b>	1	Inner Tubes, Bushings	
DEL.	Control Arm Lower-Inner Bushing 2WD 35.5mm OD bush	<b>MPU-1732K</b>	1	Inner Tubes, Bushings	
DEL.	Idler Arm Bushing 4WD	<b>MPU-0368K</b>	1	Bushings	
DEL.	Idler Arm Bushing 2WD Tapered style bush	<b>MPU-0602K</b>	1	Bushings	
DEL.	Shock Absorber Lower Bushing 4WD	<b>MPU-0031K</b>	1	Bushings	



**mitsubishi Express / Delica L300 / Starwagon SA - SE 2WD &...**

Página 2 (Continúa)

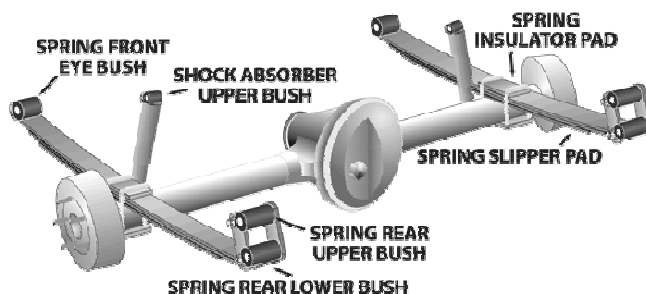
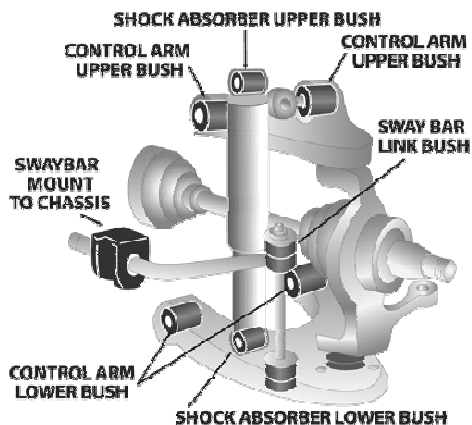

Aplicaci...	Descripción	Referencia	Kits por...	Contenido del Kit	
DEL.	Shock Absorber Upper Bushing	<b>MPU-2755SK</b>	1	Bushings	
DEL.	Sway Bar Link Outer Bushing Measure bar diameter 20,22,23,24mm available	<b>MPU-0123-__K</b>	1	Bushings	
DEL.	Sway Bar Link To Centre Bushing	<b>MPU-2092B-4K</b>	1	Bushings	
DEL.	Sway Bar Link To Chassis Bushing Measure bar diameter 12mm to 30mm available	<b>MPU-1450-__K</b>	1	Bushings	
DEL.	Sway Bar Mount to Link Bushing 9/1984 4WD Measure bar diameter 22,23,24,25,26,27,28,29mm available	<b>MPU-1117-__K</b>	1	Bushings	
TRAS.	Shock Absorber Upper / Lower Bushing	<b>MPU-2178-16K</b>	2	Bushings	
TRAS.	Spring Front Eye Bushing 4WD	<b>MPU-0171K</b>	1	Bushings	



**MITSUBISHI Express / Delica L300 / Starwagon SA - SE 2WD &...**

Página 3 (Continúa)

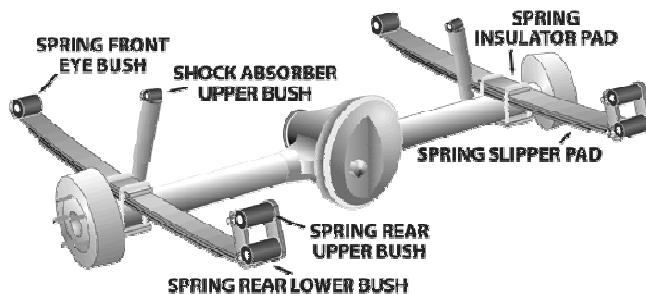
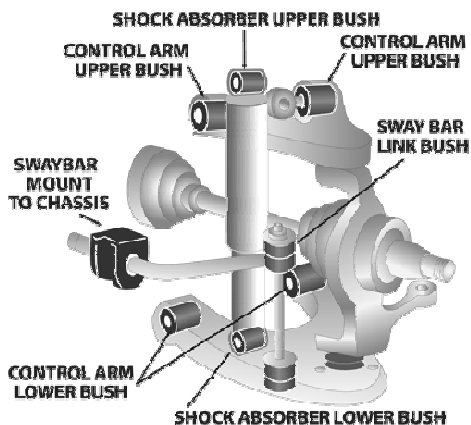







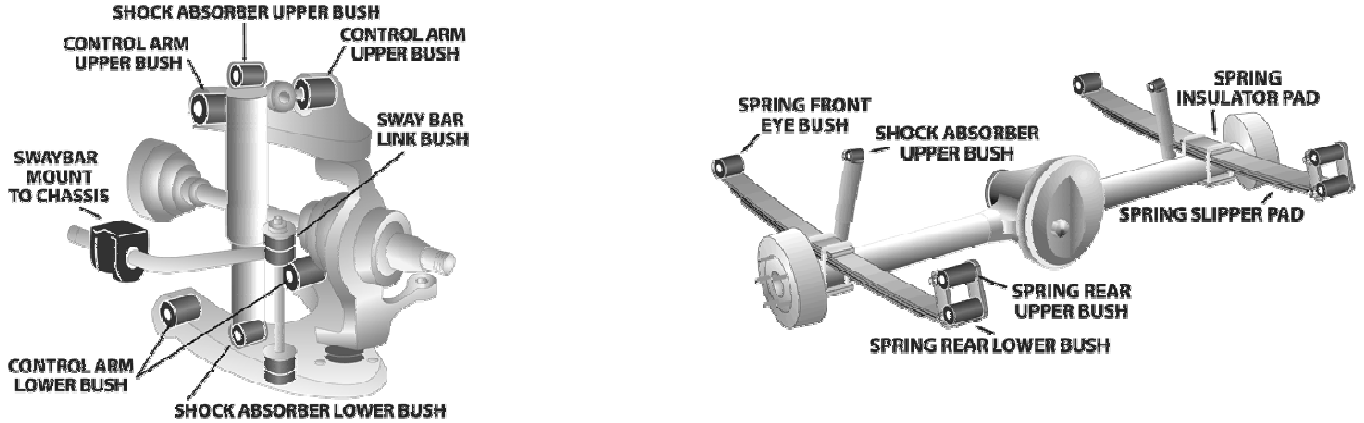

Aplicaci...	Descripción	Referencia	Kits por...	Contenido del Kit	
TRAS.	Spring Front Eye Bushing 2WD	<b>MPU-0192K</b>	1	Bushings	 SPF0192K
TRAS.	Spring Rear Eye Bushing	<b>MPU-0170K</b>	1	Bushings	 0170K
TRAS.	Spring Shackle Upper Bushing	<b>MPU-0192K</b>	1	Bushings	 SPF0192K



MITSUBISHI Express / Delica L400 Delica 4x4 Van - 1994 - 2007

Página 1









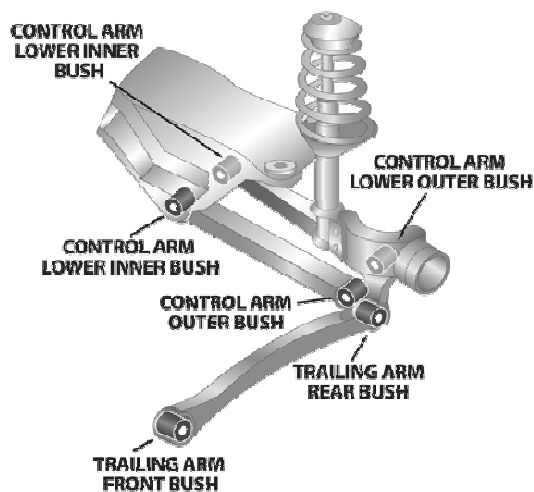
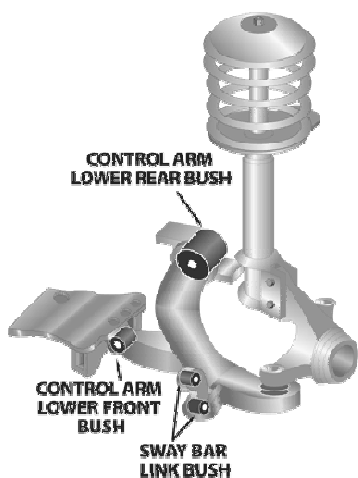

Aplicaci...	Descripción	Referencia	Kits por...	Contenido del Kit	
DEL.	Control Arm Lower-Inner Front Kit Remove original shell for fitment, Replaces original part # MR112710	MPU-3155K	1	Inner Tubes, Bushings	
DEL.	Control Arm Lower-Inner Rear Kit Remove original shell for fitment, Replaces original part # MR112711	MPU-3156K	1	Inner Tubes, Bushings	
DEL.	Gearbox Mounting Bushing Designed to fit OE bracket #MR112168	MPU-3375K	1	Outer Shells, Inner Tubes, Bushings	
DEL.	Sway Bar Mount Bushing Measure bar diameter	MPU-1493-__K	1	Bushings	
TRAS.	Sway Bar End Link Bushing	MPU-2594-4K	1	Bushings	
TRAS.	Sway Bar Mount To Axle Bushing Measure bar diameter	MPU-0343-__K	1	Bushings	



## MITSUBISHI Mirage CE - 7/1996 - 2002

Página 1









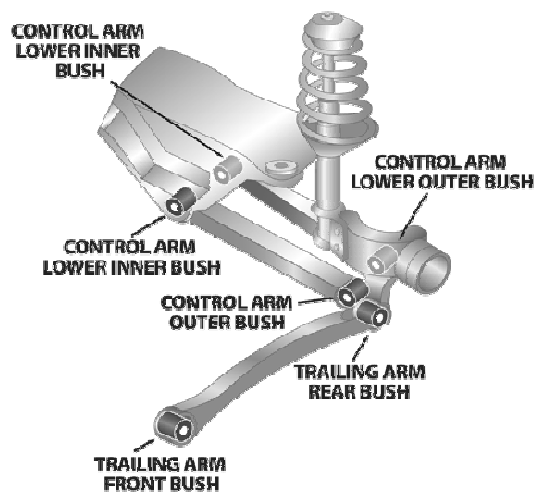
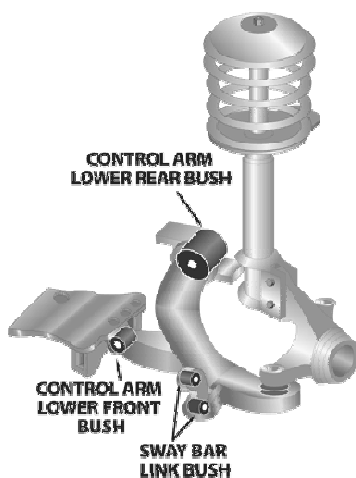

Aplicaci...	Descripción	Referencia	Kits por...	Contenido del Kit	
DEL.	Control Arm Lower Rear Bushing PS increased DS decrease caster	<b>MPU-1502K</b>	1	Bushings	
DEL.	Control Arm Lower Rear Bushing PS & DS standard	<b>MPU-1500K</b>	1	Bushings	
DEL.	Control Arm Lower Rear Bushing PS increased DS standard caster	<b>MPU-1501K</b>	1	Bushings	
DEL.	Control Arm Lower Rear Bushing PS & DS increased caster	<b>MPU-1502AK</b>	1	Bushings	
DEL.	Control Arm Lower Rear Bushing Anti lift kit maximum caster	<b>MPU-1502XK</b>	1	Bushings	
DEL.	Control Arm-Inner Front Bushing	<b>MPU-1160K</b>	1	Bushings, Inner Tubes	
TRAS.	Control Arm Lower-Inner & Outer Kit	<b>MPU-1573K</b>	1	Outer Shells, Inner Tubes, Bushings	



## MITSUBISHI Mirage CE - 7/1996 - 2002

Página 2 (Continúa)









Aplicaci...	Descripción	Referencia	Kits por...	Contenido del Kit	
TRAS.	Control Arm Upper-Inner Kit Kit includes mounting foot pin	<b>MPU-2110K</b>	1	Pin, Outer Shells, Bushings	
TRAS.	Control Arm Upper-Outer Bushing	<b>MPU-2291K</b>	1	Outer Shells, Inner Tubes, Bushings	
TRAS.	Lateral Arm Front Outer Bushing Kit includes mounting foot pin	<b>MPU-2110K</b>	1	Pin, Outer Shells, Bushings	
TRAS.	Lateral Arm Inner Bushing	<b>MPU-2291K</b>	1	Outer Shells, Inner Tubes, Bushings	
TRAS.	Lateral Arm Inner Bushing Replaces hyme joint type bush with 40.25mm OD bush	<b>MPU-2027K</b>	1	Inner Tubes, Bushings	
TRAS.	Trailing Arm - Front Bushing	<b>MPU-1574K</b>	1	Inner Tubes, Bushings	
TRAS.	Trailing Arm Lower Front Bushing	<b>MPU-1574K</b>	1	Inner Tubes, Bushings	

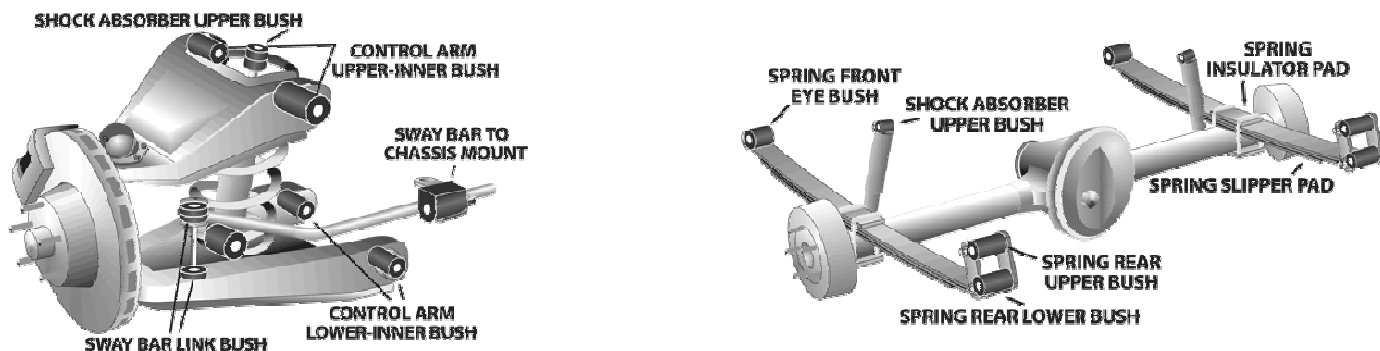

## MITSUBISHI Nimbus / Chariot Wagon UA, UB, UC - 5/1984 - ...

Página 1





Aplicaci...	Descripción	Referencia	Kits por...	Contenido del Kit	
DEL.	Control Arm Lower-Inner Bushing Re-use original shell	<b>MPU-1020K</b>	1	Inner Tubes, Bushings	
DEL.	Strut Bar To Chassis Mount Kit	<b>MPU-0448K</b>	1	Inner Tubes, Bushings	
DEL.	Sway Bar Link To Chassis Bushing	<b>MPU-2092BK</b>	1	Bushings	
DEL.	Sway Bar Mount To Chassis Bushing Measure bar diameter 26mm available	<b>MPU-1021-__K</b>	1	Bushings	
DEL.	Sway Bar To Strut Arm D Bushing	<b>MPU-1022K</b>	1	Bushings	

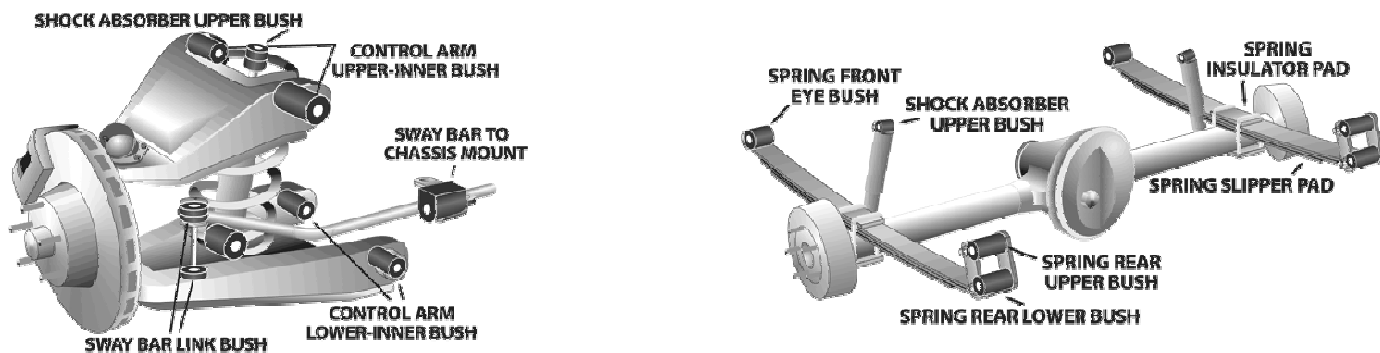

## MITSUBISHI Nimbus / Chariot Wagon UF - 1/1992 - 11/1998

Página 1









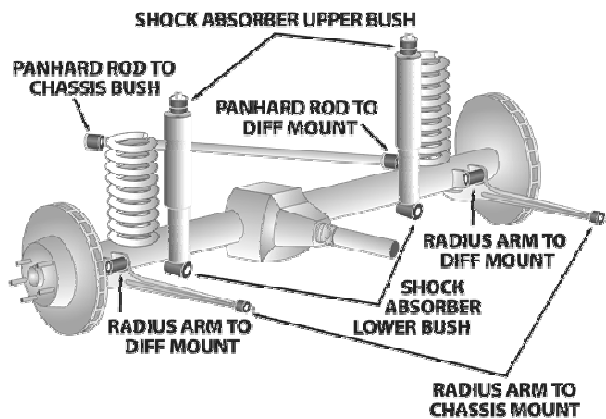
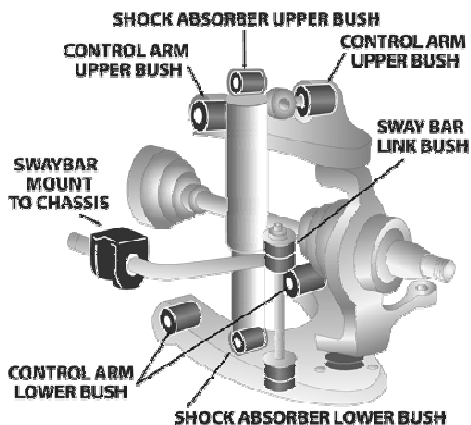

Aplicaci...	Descripción	Referencia	Kits por...	Contenido del Kit	
DEL.	Control Arm Lower Rear Bushing PS & DS standard caster, "Tube may not be required"	MPU-0837K	1	Inner Tubes, Bushings	



## MITSUBISHI Pajero / Montero NM & NP - 5/2000 - 2006

Página 1









Aplicaci...	Descripción	Referencia	Kits por...	Contenido del Kit	
DEL.	Control Arm Lower-Inner Front & Rear Remove original rubber bushing and outer shell before fitment.	<b>MPU-2774K</b>	1	Washers, Inner Tubes, Bushings	
DEL.	Control Arm Upper-Inner Kit Re-use original shell.	<b>MPU-1956K</b>	1	Inner Tubes, Bushings	
DEL.	Sway Bar Mount To Chassis Bushing Measure bar diameter 25,26,27,28,29 & 30mm available	<b>MPU-1493-__K</b>	1	Bushings	
TRAS.	Differential to Subframe Mount Kit Competition or Race use only; Remove original shell; Located at the rear of the differential.	<b>MPU-2750K</b>	1	Outer Shells, Bushings	
TRAS.	Control Arm Lower-Inner & Outer Kit	<b>MPU-2056K</b>	1	Inner Tubes, Bushings	
TRAS.	Control Arm Upper-Inner Kit Remove original shell from arm.	<b>MPU-2811K</b>	1	Washers, Inner Tubes, Bushings	
TRAS.	Differential Front Support Mount Kit Both ends of aluminum brace arm at front of diff.	<b>MPU-2739K</b>	1	Inner Tubes, Bushings	

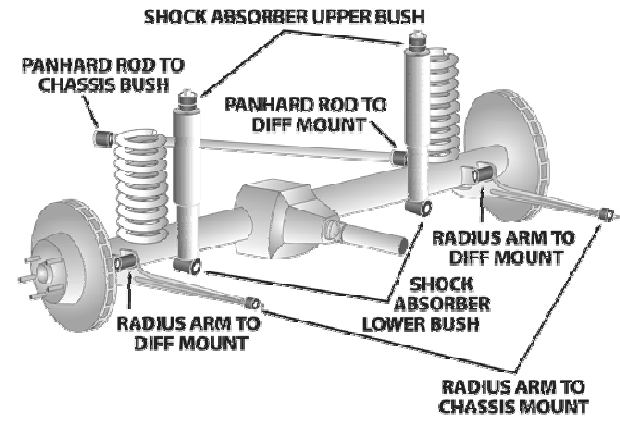
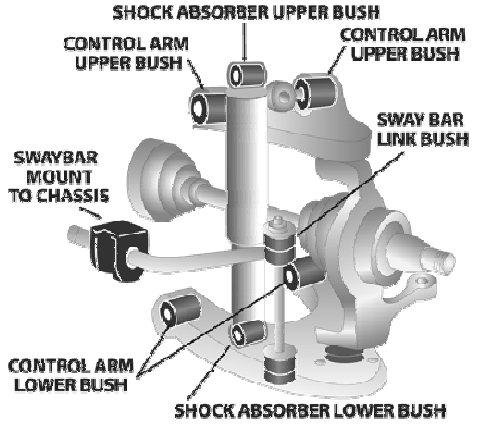

**MITSUBISHI Pajero / Montero NM & NP - 5/2000 - 2006**

Página 2 (Continúa)



Aplicaci...	Descripción	Referencia	Kits por...	Contenido del Kit	
TRAS.	Sway Bar Mount Bushing Measure bar diameter 18,20,23,24,25,26,27,28mm available	<b>MPU-0343-__K</b>	1	Bushings	
TRAS.	Toe Control Arm - Inner Bushing	<b>MPU-2057K</b>	1	Inner Tubes, Bushings	
TRAS.	Trailing Arm Lower Front Bushing	<b>MPU-2777K</b>	1	Outer Shells, Inner Tubes, Bushings	
TRAS.	Trailing Arm Lower Rear Bushing Remove original outer shell before fitment of SuperPro bushing.	<b>MPU-2055K</b>	1	Inner Tubes, Bushings	



MITSUBISHI Pajero / Montero NA, NB, NC, ND, NE, NF & NG -...

Página 1

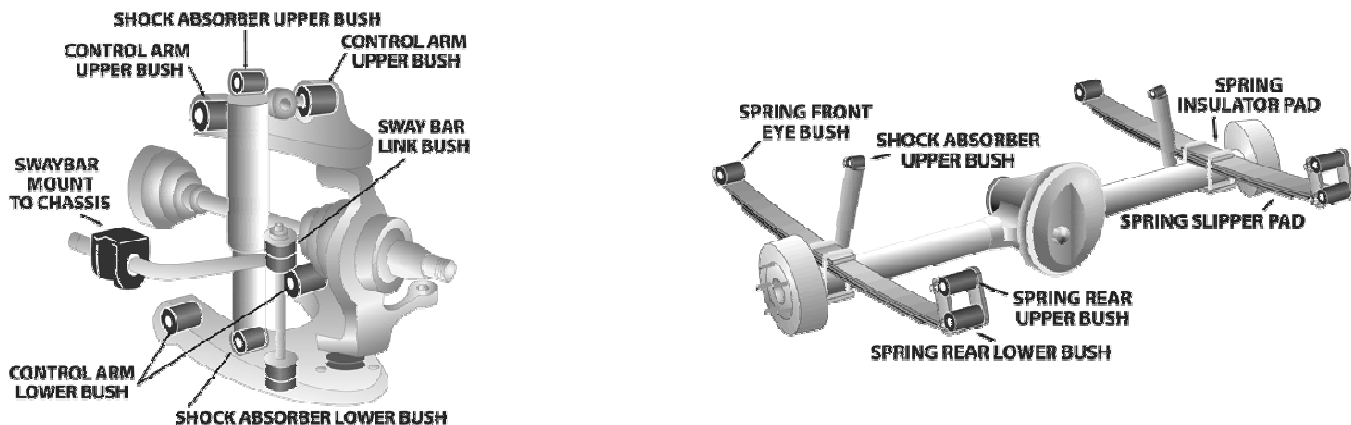

Aplicaci...	Descripción	Referencia	Kits por...	Contenido del Kit	
DEL.	Idler Arm Bushing NA to NG	MPU-0368K	1	Bushings	
DEL.	Shock Absorber Lower Bushing	MPU-0031K	1	Bushings	
DEL.	Shock Absorber Upper Bushing	MPU-0094K	1	Bushings	
DEL.	Sway Bar Link To Chassis Bushing	MPU-2092B-4K	1	Bushings	
DEL.	Sway Bar Link To Lower Arm Bushing	MPU-2092B-4K	1	Bushings	
DEL.	Sway Bar Mount To Chassis Bushing NF-NG "Includes link bush" Measure bar diameter as 23,25,27,29mm are available	MPU-1101-__K	1	Bushings	
DEL.	Sway Bar Mount To Chassis Bushing NA to NE measure bar diameter as 22,23,24,25,26,27,28,29mm available	MPU-1117-__K	1	Bushings	





**MITSUBISHI Pajero / Montero NA, NB, NC, ND, NE, NF & NG - ...**

Página 2 (Continúa)

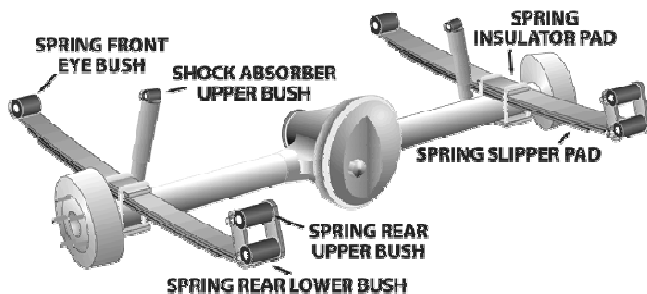
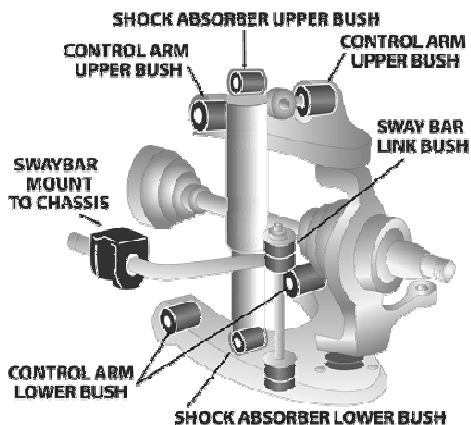







Aplicaci...	Descripción	Referencia	Kits por...	Contenido del Kit	
TRAS.	Trailing Arm-To Chassis Mount Bushing Coil model, Vehicle has no locating washers- Locating spigot is part of the bushing	<b>MPU-1456K</b>	1	Bushings	
TRAS.	Leaf Spring Bushing All Leaf spring model SPF0192Kx1 SPF0244Kx1 SPF0187Kx1	<b>MPK-072K</b>	1		
TRAS.	Panhard Rod Bushing	<b>MPU-1245K</b>	1	Bushings, Inner Tubes	
TRAS.	Shock Absorber Upper / Lower Bushing Leaf spring model only	<b>MPU-2178-16K</b>	2	Bushings	
TRAS.	Spring Front Eye Bushing Leaf spring model with 18mm pin	<b>MPU-0244K</b>	1	Bushings	
TRAS.	Spring Rear Eye Bushing Leaf spring model	<b>MPU-0192K</b>	1	Bushings	
TRAS.	Spring Shackle Upper Bushing Leaf spring model	<b>MPU-0187K</b>	1	Bushings	

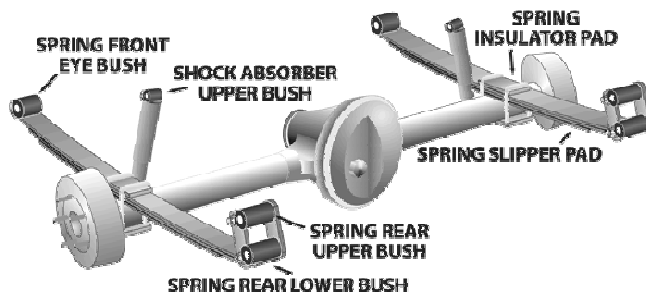
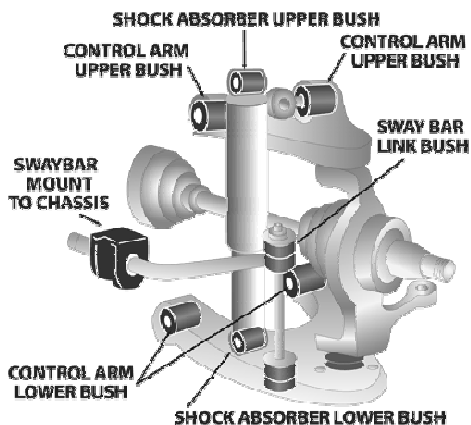

**MITSUBISHI Pajero / Montero NA, NB, NC, ND, NE, NF & NG -...**

Página 3 (Continúa)









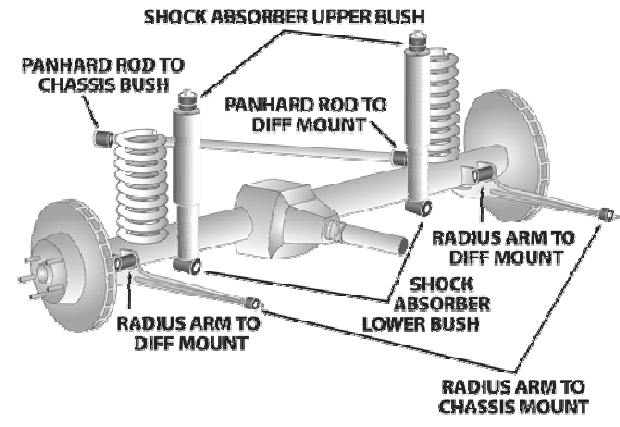
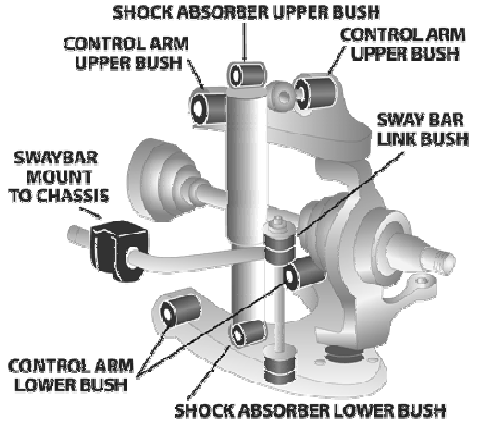

Aplicaci...	Descripción	Referencia	Kits por...	Contenido del Kit	
TRAS.	Sway Bar Link Bushing Kit	<b>MPU-2092BK</b>	1	Bushings	
TRAS.	Sway Bar Mount To Axle Bushing NF to NG measure bar diameter as 18,24,25,26,27,28mm are available	<b>MPU-0343-__K</b>	1	Bushings	
TRAS.	Trailing Arm - To Diff Mount Bushing Coil model, "65mm OD bush check size"	<b>MPU-1243K</b>	1	Inner Tubes, Bushings	
TRAS.	Trailing Arm - To Diff Mount Bushing Coil model, "60mm OD bush check size"	<b>MPU-1455K</b>	1	Bushings, Inner Tubes	
TRAS.	Trailing Arm-To Chassis Mount Bushing Coil model, Vehicle has factory locating washers welded to chassis bracket	<b>MPU-1244K</b>	1	Bushings	



MITSUBISHI Pajero / Montero NH, NJ, NK & NL - 5/1991 - ...

Página 1



Aplicaci...	Descripción	Referencia	Kits por...	Contenido del Kit	
DEL.	Control Arm Lower Rear Bushing Mounted to cross-member; Do not remove OE shell; Replaces original part number MB109662.	MPU-2302K	1	Inner Tubes, Bushings	
DEL.	Control Arm Lower-Front Bushing	MPU-2301K	1	Inner Tubes, Bushings	
DEL.	Control Arm Upper-Inner Kit Re-use original shell	MPU-1740K	1	Inner Tubes, Bushings	
DEL.	Idler Arm Bushing NH to NJ	MPU-0956K	1	Bushings	
DEL.	Sway Bar Mount To Chassis Bushing Measure bar diameter 25,26,27,28,29 & 30mm available	MPU-1493-__K	1	Bushings	
TRAS.	Leaf Spring Bushing All Leaf spring model complete rear spring bushing kit	MPK-072K	1		
TRAS.	Panhard Rod Bushing	MPU-1245K	1	Bushings, Inner Tubes	



## MITSUBISHI Pajero / Montero NH, NJ, NK & NL - 5/1991 - ...

Página 2 (Continúa)

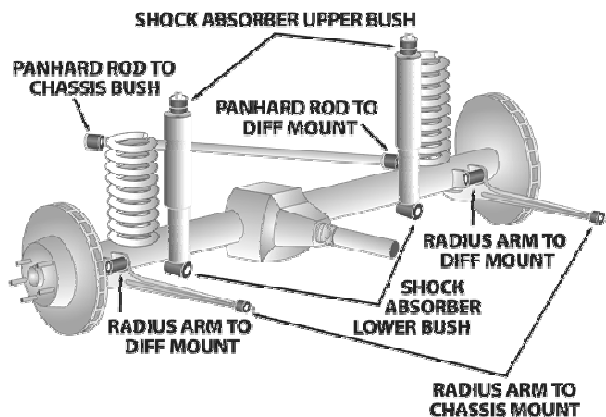
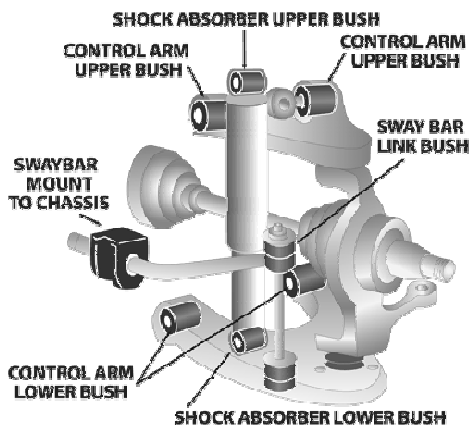





Aplicaci...	Descripción	Referencia	Kits por...	Contenido del Kit	
TRAS.	Spring Front Eye Bushing Leaf spring model with 18mm pin	<b>MPU-0244K</b>	1	Bushings	<b>0244K</b>
TRAS.	Spring Rear Eye Bushing Leaf spring model	<b>MPU-0192K</b>	1	Bushings	<b>SPF0192K</b>
TRAS.	Spring Shackle Upper Bushing Leaf spring model	<b>MPU-0187K</b>	1	Bushings	<b>SPF0187K</b>
TRAS.	Sway Bar Link Bushing Kit	<b>MPU-2092BK</b>	1	Bushings	<b>SPF2092BK</b>
TRAS.	Sway Bar Mount To Axle Bushing Measure bar diameter 18,24,25,26,27,28mm available	<b>MPU-0343-__K</b>	1	Bushings	<b>0343-__K</b>
TRAS.	Trailing Arm - To Diff Mount Bushing 65mm OD bush, check size	<b>MPU-1243K</b>	1	Inner Tubes, Bushings	<b>SPF1243K</b>
TRAS.	Trailing Arm - To Diff Mount Bushing 60mm OD bush, check size	<b>MPU-1455K</b>	1	Bushings, Inner Tubes	<b>1455K</b>

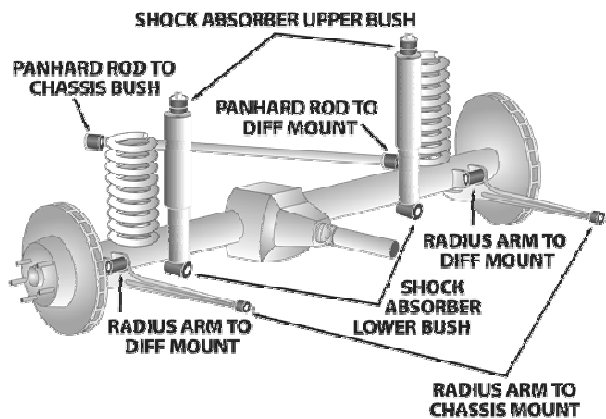
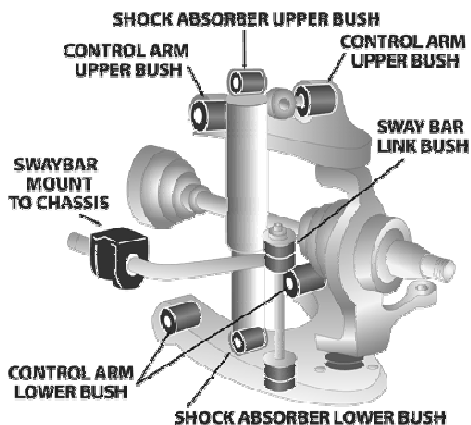

MITSUBISHI Pajero / Montero NH, NJ, NK & NL - 5/1991 - ...

Página 3 (Continúa)









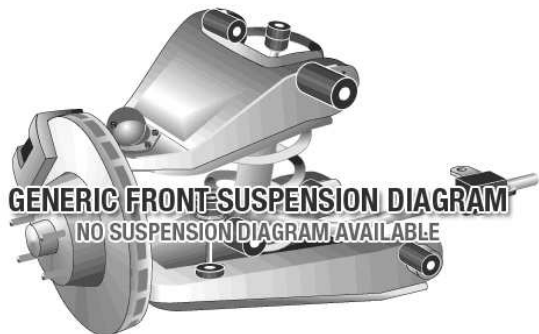

Aplicaci...	Descripción	Referencia	Kits por...	Contenido del Kit	
TRAS.	Trailing Arm-To Chassis Mount Bushing Has factory location washers welded to chassis bracket	<b>MPU-1244K</b>	1	Bushings	
TRAS.	Trailing Arm-To Chassis Mount Bushing No factory locating washers - locating spigot is part of bush	<b>MPU-1456K</b>	1	Bushings	



## MITSUBISHI Pajero / Montero NS, NT & NW - 2006 - Current

Página 1









Aplicaci...	Descripción	Referencia	Kits por...	Contenido del Kit	
DEL.	Control Arm Lower-Inner Front & Rear Remove original rubber bushing and outer shell before fitment.	<b>MPU-2774K</b>	1	Washers, Inner Tubes, Bushings	
DEL.	Control Arm Upper-Inner Kit Re-use original shell.	<b>MPU-1956K</b>	1	Inner Tubes, Bushings	
DEL.	Sway Bar Mount To Chassis Bushing Measure bar diameter	<b>MPU-1493-__K</b>	1	Bushings	
TRAS.	Control Arm Lower-Inner & Outer Kit	<b>MPU-2056K</b>	1	Inner Tubes, Bushings	
TRAS.	Control Arm Upper-Inner Kit Remove original shell from arm.	<b>MPU-2811K</b>	1	Washers, Inner Tubes, Bushings	
TRAS.	Differential Front Support Mount Kit Both ends of aluminum brace arm at front of diff.	<b>MPU-2739K</b>	1	Inner Tubes, Bushings	
TRAS.	Differential to Subframe Mount Kit Competition or Race use only; Remove original shell; Located at the rear of the differential.	<b>MPU-2750K</b>	1	Outer Shells, Bushings	

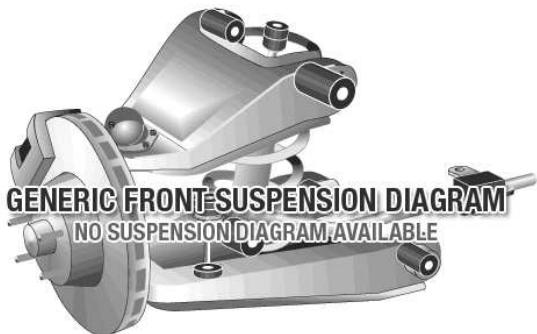

## MITSUBISHI Pajero / Montero NS, NT & NW - 2006 - Current

Página 2 (Continúa)



Aplicaci...	Descripción	Referencia	Kits por...	Contenido del Kit	
TRAS.	Sway Bar Mount Bushing Measure bar diameter	MPU-0343-__K	1	Bushings	
TRAS.	Toe Control Arm - Inner Bushing	MPU-2057K	1	Inner Tubes, Bushings	
TRAS.	Trailing Arm Lower Front Bushing	MPU-2777K	1	Outer Shells, Inner Tubes, Bushings	
TRAS.	Trailing Arm Lower Rear Bushing Remove original outer shell before fitment of SuperPro bushing.	MPU-2055K	1	Inner Tubes, Bushings	



**MITSUBISHI Triton / Strada / L200 2WD & 4WD, MK -...**

Página 1

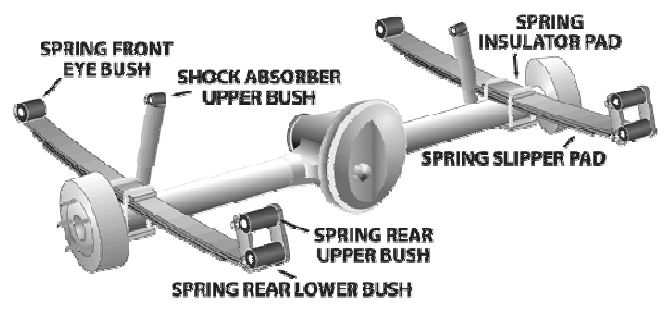
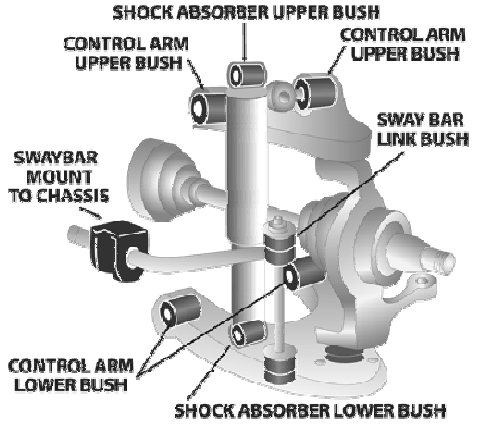

Aplicaci...	Descripción	Referencia	Kits por...	Contenido del Kit	
DEL.	Control Arm Upper-Inner Kit 2WD	<b>MPU-1153K</b>	1	Inner Tubes, Bushings	
DEL.	Control Arm Lower Rear Bushing 4WD Replaces original number MB633870, Remove original shell, Bushing mounted in cross-...	<b>MPU-2932K</b>	1	Inner Tubes, Bushings	
DEL.	Control Arm Lower-Front Bushing 4WD Only, 40mm ID Eye	<b>MPU-1259K</b>	1	Inner Tubes, Bushings	
DEL.	Control Arm Lower-Front Bushing 4WD Only, 36mm ID Eye	<b>MPU-2301K</b>	1	Inner Tubes, Bushings	
DEL.	Control Arm Lower-Inner Bushing 2WD Only, Do not remove original shell as it has to be re-used	<b>MPU-2503K</b>	1	Inner Tubes, Bushings	
DEL.	Control Arm Upper-Inner Kit 4WD, Re-use the original shell	<b>MPU-1740K</b>	1	Inner Tubes, Bushings	
DEL.	Shock Absorber Lower Bushing	<b>MPU-0031K</b>	1	Bushings	





**MITSUBISHI Triton / Strada / L200 2WD & 4WD, MK -...**

Página 2 (Continúa)

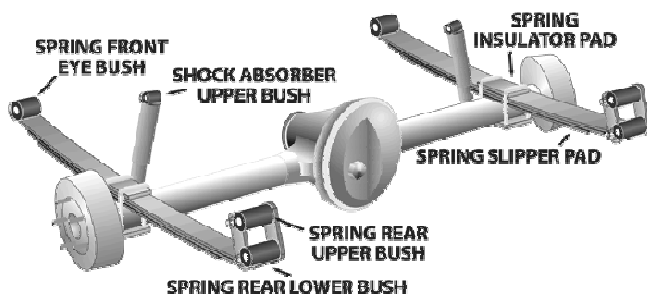
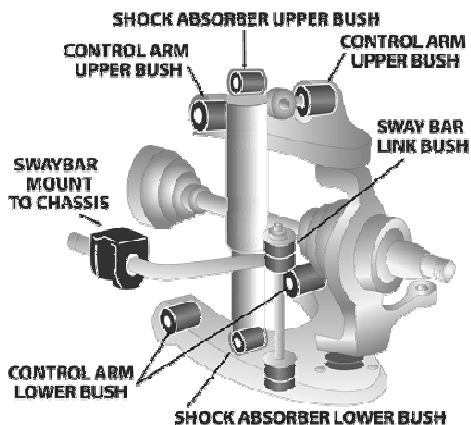







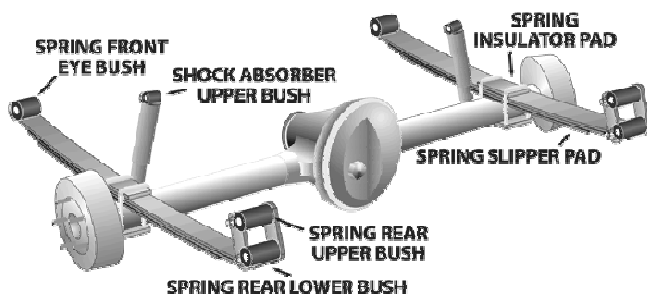
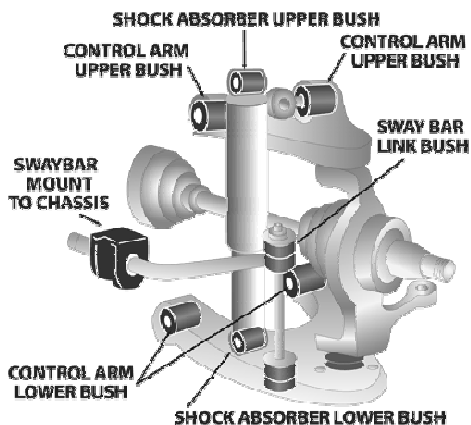

Aplicaci...	Descripción	Referencia	Kits por...	Contenido del Kit	
DEL.	Shock Absorber Upper Bushing	<b>MPU-0094K</b>	1	Bushings	
DEL.	Strut Bar To Chassis Mount Kit 2WD	<b>MPU-1258K</b>	1	Inner Tubes, Bushings	
DEL.	Sway Bar End Bushing One size fits all	<b>MPU-2096K</b>	1	Bushings	
DEL.	Sway Bar Link To Chassis Bushing	<b>MPU-2092B-4K</b>	1	Bushings	
DEL.	Sway Bar To Link D Bushing Measure bar diameter 22,23,24,25,26,27,28,29mm available	<b>MPU-1117-__K</b>	1	Bushings	
TRAS.	Leaf Spring Bushing All To suit 32mm ID front eye, 1xSPF0187K, 1xSPF0192K, 1xSPF2294K	<b>MPK-160K</b>	1	Bushings, Inner Tubes	
TRAS.	Leaf Spring Bushing All To suit 36mm ID front eye, SPF0187Kx1, SPF0192Kx1, SPF0713Kx1	<b>MPK-073K</b>	1	Inner Tubes, Bushings	



MITSUBISHI Triton / Strada / L200 2WD & 4WD, MK -...

Página 3 (Continúa)









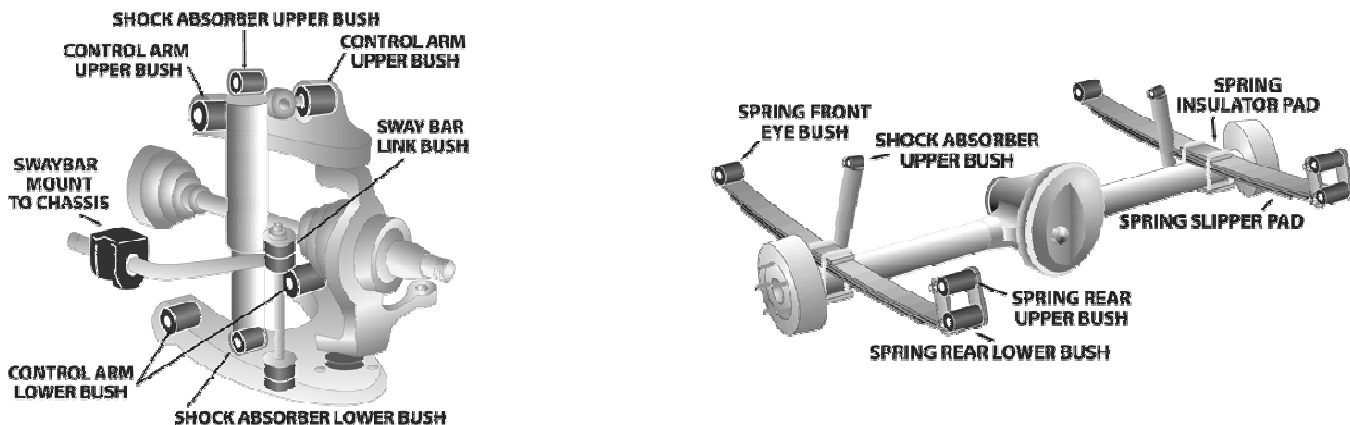

Aplicaci...	Descripción	Referencia	Kits por...	Contenido del Kit	
TRAS.	Leaf Spring Bushing All To suit 41mm ID front eye, Kit contents SPF0187Kx1, SPF0192Kx1, SPF1983Kx1	MPK-083K	1	Inner Tubes, Bushings	
TRAS.	Shock Absorber Upper / Lower Bushing	MPU-2178-16K	2	Bushings	
TRAS.	Spring Front Eye Bushing 36mm ID eye	MPU-0713K	1	Inner Tubes, Bushings	
TRAS.	Spring Front Eye Bushing 41mm ID eye	MPU-1983K	1	Inner Tubes, Bushings	
TRAS.	Spring Front Eye Bushing 32mm ID eye	MPU-2294K	1	Inner Tubes, Bushings	
TRAS.	Spring Rear Eye Bushing	MPU-0192K	1	Bushings	
TRAS.	Spring Shackle Upper Bushing	MPU-0187K	1	Bushings	



**MITSUBISHI Triton / Strada / L200 2WD & 4WD, ME, MF, MG,...**

Página 1









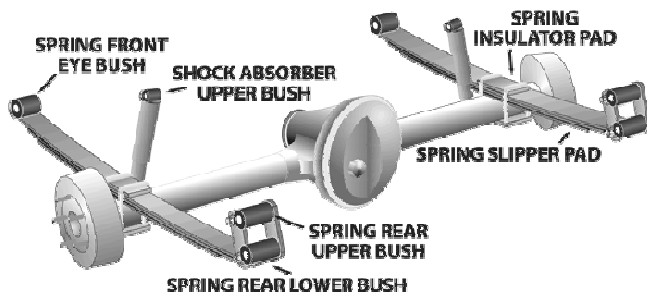
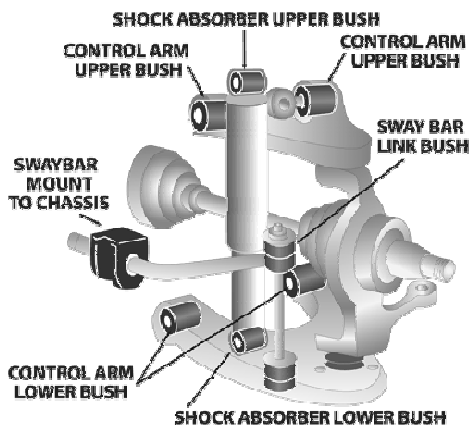

Aplicaci...	Descripción	Referencia	Kits por...	Contenido del Kit	
DEL.	Control Arm Lower-Front Bushing 4WD Only, 40mm ID Eye	<b>MPU-1259K</b>	1	Inner Tubes, Bushings	
DEL.	Control Arm Lower Rear Bushing 4WD Only; Do not remove OE shell; Replaces original part number MB109662.	<b>MPU-2302K</b>	1	Inner Tubes, Bushings	
DEL.	Control Arm Lower-Front Bushing 4WD Only, 36mm ID Eye	<b>MPU-2301K</b>	1	Inner Tubes, Bushings	
DEL.	Control Arm Lower-Inner Bushing 2WD, Tapered style bush	<b>MPU-1152K</b>	1	Bushings	
DEL.	Control Arm Upper-Inner Kit 2WD	<b>MPU-1153K</b>	1	Inner Tubes, Bushings	
DEL.	Idler Arm Bushing 4WD ( Excluding V6 )	<b>MPU-0368K</b>	1	Bushings	
DEL.	Idler Arm Bushing 2WD Tapered 21.1mm up to 22.9mm, 15.75mm ID	<b>MPU-1262K</b>	1	Bushings	



**MITSUBISHI Triton / Strada / L200 2WD & 4WD, ME, MF, MG,...**

Página 2 (Continúa)









Aplicaci...	Descripción	Referencia	Kits por...	Contenido del Kit	
DEL.	Shock Absorber Lower Bushing	<b>MPU-0031K</b>	1	Bushings	
DEL.	Shock Absorber Upper Bushing	<b>MPU-0094K</b>	1	Bushings	
DEL.	Strut Bar To Chassis Mount Kit 2WD	<b>MPU-1258K</b>	1	Inner Tubes, Bushings	
DEL.	Sway Bar Link Bushing Kit 2WD	<b>MPU-2092BK</b>	1	Bushings	
DEL.	Sway Bar Link To Chassis Bushing 4WD	<b>MPU-2755SK</b>	1	Bushings	
DEL.	Sway Bar To Link D Bushing Measure bar diameter 22,23,24,25,26,27,28,29mm available	<b>MPU-1117-__K</b>	1	Bushings	
DEL.	Sway Bar To Lower Control Arm Kit 4WD	<b>MPU-2755SK</b>	1	Bushings	

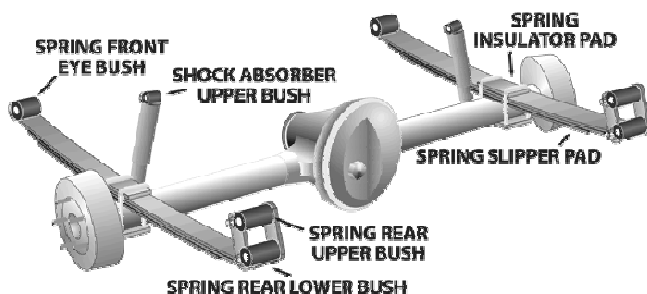
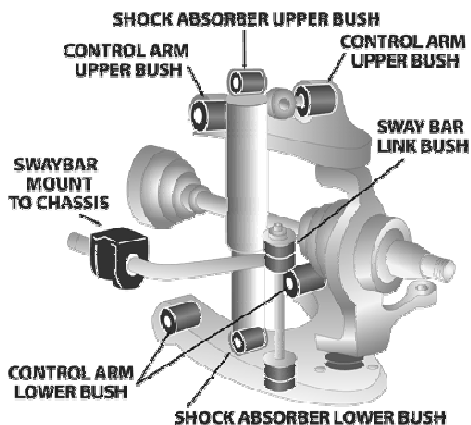

MITSUBISHI Triton / Strada / L200 2WD & 4WD, ME, MF, MG,...

Página 3 (Continúa)









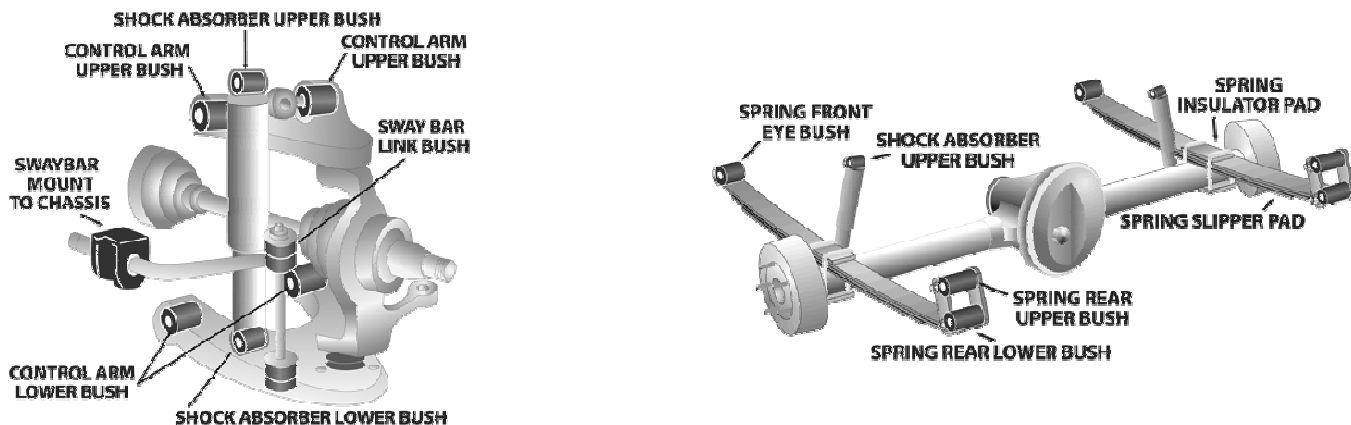

Aplicaci...	Descripción	Referencia	Kits por...	Contenido del Kit	
TRAS.	Leaf Spring Bushing All To suit 36mm ID front eye, SPF0187Kx1, SPF0192Kx1, SPF0713Kx1	<b>MPK-073K</b>	1	Inner Tubes, Bushings	
TRAS.	Shock Absorber Upper / Lower Bushing	<b>MPU-2178-16K</b>	2	Bushings	
TRAS.	Spring Front Eye Bushing 36mm ID eye	<b>MPU-0713K</b>	1	Inner Tubes, Bushings	
TRAS.	Spring Rear Eye Bushing	<b>MPU-0192K</b>	1	Bushings	
TRAS.	Spring Shackle Upper Bushing	<b>MPU-0187K</b>	1	Bushings	

**MITSUBISHI Triton / Strada / L200 2WD & 4WD, ML - 7/2006 -...**

Página 1





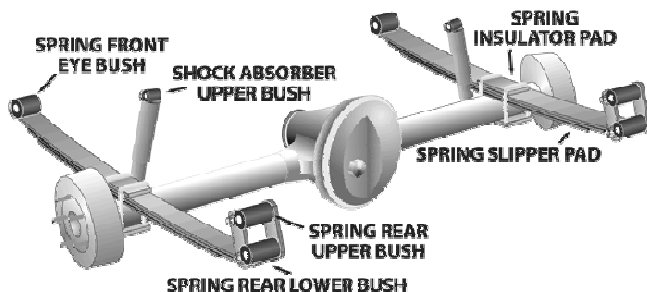
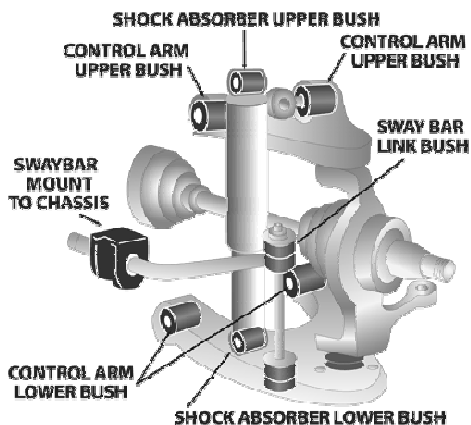

Aplicaci...	Descripción	Referencia	Kits por...	Contenido del Kit	
DEL.	Spring Insulator Pad Bushing Upper spring seat bushing	<b>MPU-2994K</b>	1	Bushings	
DEL.	Steering Rack & Pinion Mount Bush.....Power Steering	<b>MPU-2992K</b>	1	Inner Tubes, Bushings	
DEL.	Sway Bar Mount Bushing Measure bar diameter 20,25.4, 27,28 & 30mm available	<b>MPU-2993-__K</b>	1	Bushings	
DEL.	Control Arm Lower-Inner Bushing Remove original shell before fitment	<b>MPU-2991K</b>	1	Washers, Inner Tubes, Bushings	
DEL.	Control Arm Upper-Inner Kit Do not remove original shell as it must be re-used	<b>MPU-2990K</b>	1	Inner Tubes, Bushings	
DEL.	Shock Absorber Lower Bushing Original shock only	<b>MPU-2996K</b>	1	Bushings, Outer Shells, Inner Tubes	
DEL.	Shock Absorber Upper Bushing Bushings located in upper steel mount, NOTE must re-use original washers	<b>MPU-2995K</b>	1	Inner Tubes, Bushings	

**MITSUBISHI Triton / Strada / L200 2WD & 4WD, ML - 7/2006 -...**

Página 2 (Continúa)



Aplicaci...	Descripción	Referencia	Kits por...	Contenido del Kit	
TRAS.	Spring Rear Eye Bushing	<b>MPU-0192K</b>	1	Bushings	 SPF0192K
TRAS.	Spring Shackle Upper Bushing	<b>MPU-0187K</b>	1	Bushings	 SPF0187K
TRAS.	Leaf Spring Bushing All 4WD complete rear leaf spring bushing kit, SPF1983Kx1, SPF0192Kx1, SPF0187Kx1	<b>MPK-143K</b>	1	Inner Tubes, Bushings	
TRAS.	Spring Front Eye Bushing 41mm ID eye	<b>MPU-1983K</b>	1	Inner Tubes, Bushings	 1983K



**MITSUBISHI Triton / Strada / L200 2WD & 4WD, MC - 1982 -...**

Página 1

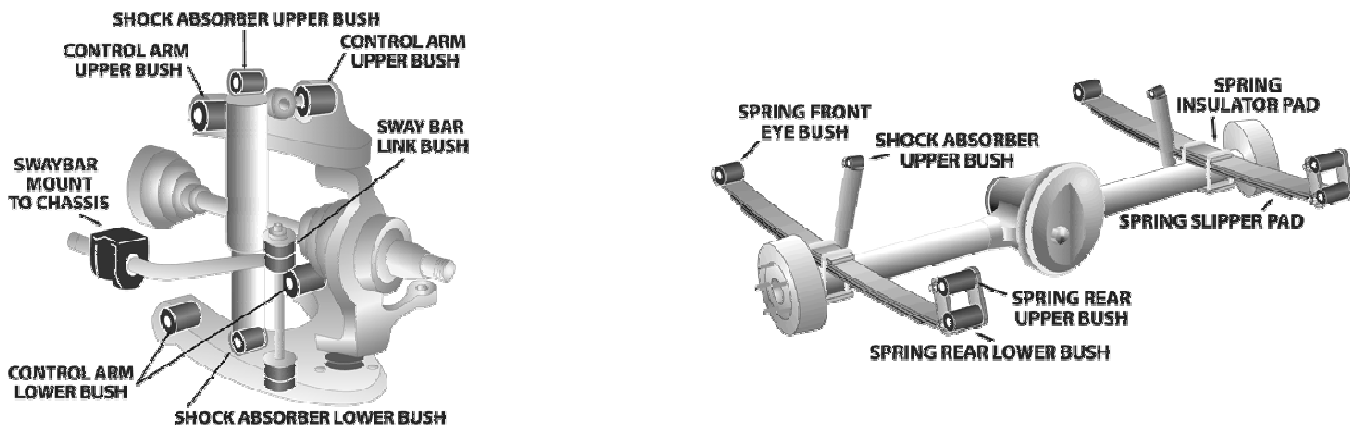

Aplicaci...	Descripción	Referencia	Kits por...	Contenido del Kit	
DEL.	Control Arm Lower-Inner Bushing 2WD.	<b>MPU-1152K</b>	1	Bushings	
DEL.	Control Arm Lower-Inner Bushing 34mm OD bush.	<b>MPU-1208K</b>	1	Inner Tubes, Bushings	
DEL.	Control Arm Lower-Inner Bushing 35.5mm OD bush; Suit crush tube style pin, not shoulder bolt.	<b>MPU-1732K</b>	1	Inner Tubes, Bushings	
DEL.	Shock Absorber Lower Bushing 4WD	<b>MPU-0031K</b>	1	Bushings	
DEL.	Shock Absorber Upper Bushing	<b>MPU-2755SK</b>	1	Bushings	
DEL.	Sway Bar Link Outer Bushing Bar diameters 20,22,23,24mm available.	<b>MPU-0123-__K</b>	1	Bushings	
DEL.	Sway Bar Link To Centre Bushing	<b>MPU-2092B-4K</b>	1	Bushings	





**MITSUBISHI Triton / Strada / L200 2WD & 4WD, MC - 1982 -...**

Página 2 (Continúa)

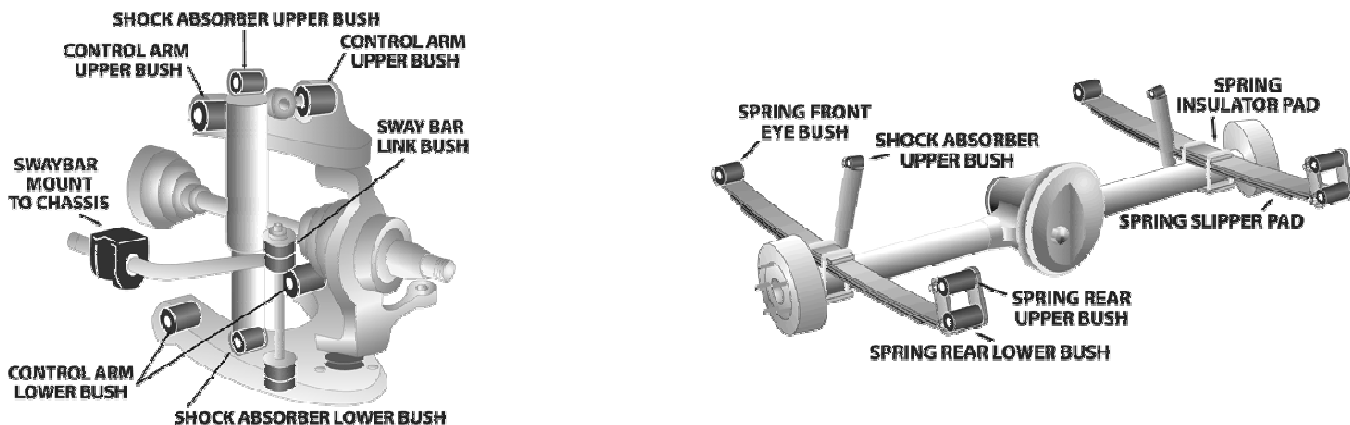

Aplicaci...	Descripción	Referencia	Kits por...	Contenido del Kit	
DEL.	Sway Bar Link To Chassis Bushing Bar diameters 12mm to 30mm available.	<b>MPU-1450-__K</b>	1	Bushings	
DEL.	Sway Bar Mount Bushing 4WD 1984; Bar diameters 22, 23, 24, 25, 26, 27, 28 and 29mm available.	<b>MPU-1117-__K</b>	1	Bushings	
TRAS.	Shock Absorber Upper / Lower Bushing	<b>MPU-2178-16K</b>	2	Bushings	
TRAS.	Spring Eye Bushing All	<b>MPU-0192K</b>	1	Bushings	
TRAS.	Spring Front Eye Bushing 2WD	<b>MPU-0171K</b>	1	Bushings	
TRAS.	Spring Shackle Upper Bushing	<b>MPU-0187K</b>	1	Bushings	



## MITSUBISHI 3000 GT Z16 - 10/1992 - 12/1996

Página 1

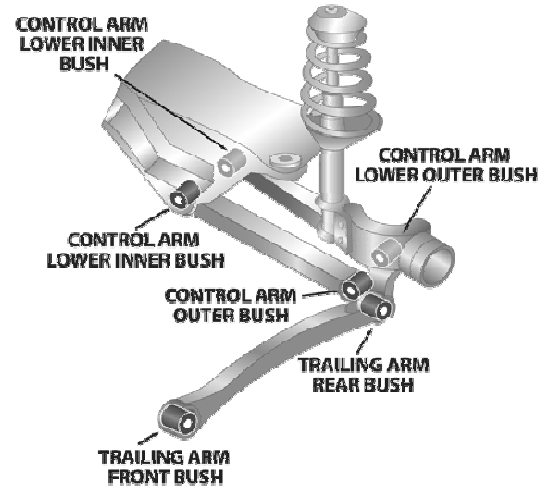
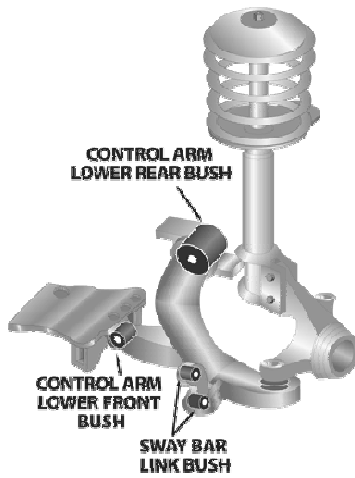

Aplicaci...	Descripción	Referencia	Kits por...	Contenido del Kit	
DEL.	Control Arm Lower Rear Bushing "Locking nut on mount peg" PS & DS Standard	<b>MPU-1240K</b>	1	Washers, Outer Shells, Inner Tubes, Bushings	
DEL.	Control Arm Lower Rear Bushing "Locking nut on mount peg" PS Inc / DS Standard	<b>MPU-1241K</b>	1	Bushings, Inner Tubes, Outer Shells, Washers	
DEL.	Control Arm Lower Rear Bushing "Locking nut on mount peg" PS & DS Inc or Dec	<b>MPU-1242K</b>	1	Bushings, Inner Tubes, Outer Shells, Washers	
DEL.	Control Arm Lower Rear-Bracket Mount	<b>MPU-2451K</b>	1	Bushings, Inner Tubes, Washers	
DEL.	Control Arm Lower-Front Bushing	<b>MPU-2450K</b>	1	Bushings, Inner Tubes	
DEL.	Sway Bar Mount To Chassis Bushing Measure sway bar diameter, 20, 21, 22, 23, 24mm available	<b>MPU-1257-__K</b>	1	Bushings	
TRAS.	Sway Bar Link Bushing Kit	<b>MPU-2092B-4K</b>	1	Bushings	



## MITSUBISHI FTO Sports Coupe - 1995 - 1999

Página 1

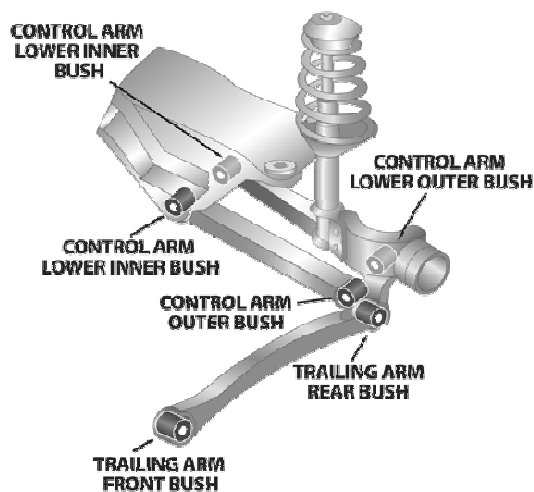
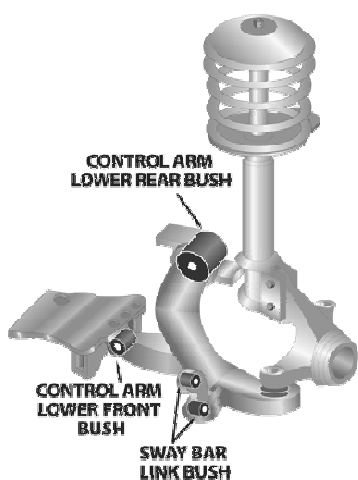





Aplicaci...	Descripción	Referencia	Kits por...	Contenido del Kit	
DEL.	Control Arm Lower Rear Bushing PS & DS standard	<b>MPU-1500K</b>	1	Bushings	
DEL.	Control Arm Lower Rear Bushing PS increased DS standard caster	<b>MPU-1501K</b>	1	Bushings	
DEL.	Control Arm Lower Rear Bushing PS & DS increased caster	<b>MPU-1502AK</b>	1	Bushings	
DEL.	Control Arm Lower Rear Bushing PS increased DS decrease caster	<b>MPU-1502K</b>	1	Bushings	
DEL.	Control Arm Lower Rear Bushing Anti lift kit maximum caster	<b>MPU-1502XK</b>	1	Bushings	
DEL.	Control Arm-Inner Front Bushing	<b>MPU-1160K</b>	1	Bushings, Inner Tubes	
DEL.	Sway Bar Mount To Chassis Bushing Measure bar diameter 16,18,19,20 & 22mm available	<b>MPU-1344-__K</b>	1	Bushings	

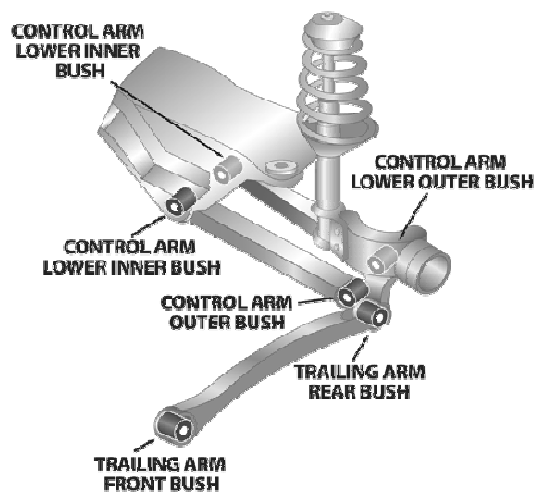
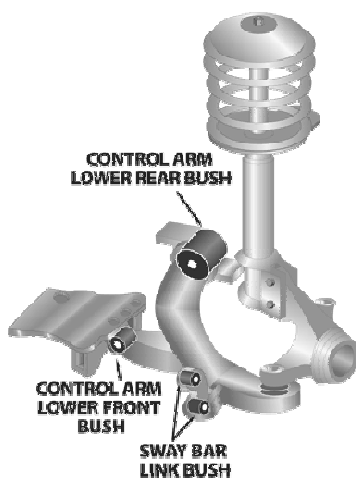

## MITSUBISHI FTO Sports Coupe - 1995 - 1999

Página 2 (Continúa)









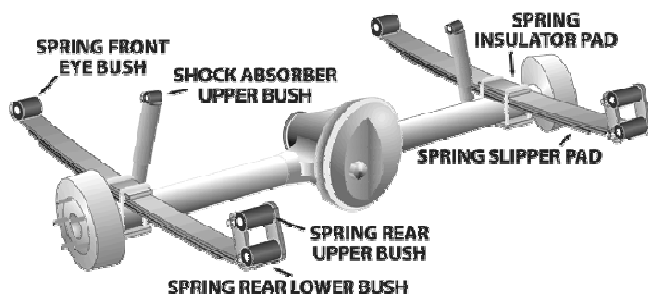
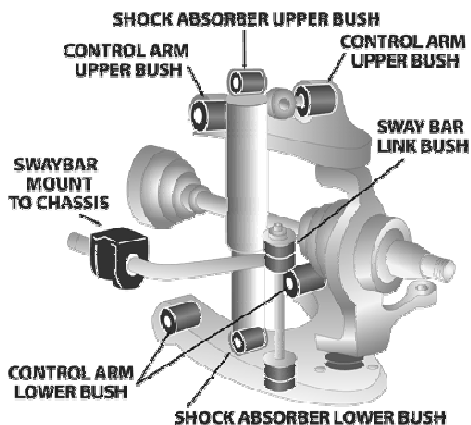

Aplicaci...	Descripción	Referencia	Kits por...	Contenido del Kit	
TRAS.	Sway Bar Link Bushing Kit	<b>MPU-2092BK</b>	1	Bushings	 SPF2092BK
TRAS.	Sway Bar Mount To Chassis Bushing Measure bar diameter 17,18mm available	<b>MPU-2004-__K</b>	1	Bushings	
TRAS.	Trailing Arm - Front Bushing	<b>MPU-1574K</b>	1	Inner Tubes, Bushings	 1 5 7 4 K



## MITSUBISHI Challenger / Montero Sport / Pajero Sport PA1...

Página 1





Aplicaci...	Descripción	Referencia	Kits por...	Contenido del Kit	
DEL.	Control Arm Upper-Inner Kit Re-use original shell	<b>MPU-1740K</b>	1	Inner Tubes, Bushings	 SPF1740K
DEL.	Idler Arm Bushing	<b>MPU-0956K</b>	1	Bushings	 0956K
DEL.	Sway Bar End Bushing One size fits all	<b>MPU-2096K</b>	1	Bushings	 2096K
DEL.	Sway Bar Mount to Link Bushing Measure bar diameter 27 & 31mm available	<b>MPU-1976-__K</b>	1	Bushings	
TRAS.	Spring Rear Eye Bushing	<b>MPU-0192K</b>	1	Bushings	 SPF0192K
TRAS.	Spring Front Eye Bushing Suited to original spring	<b>MPU-2369K</b>	1	Inner Tubes, Bushings	
TRAS.	Spring Shackle Upper Bushing	<b>MPU-0187K</b>	1	Bushings	 SPF0187K

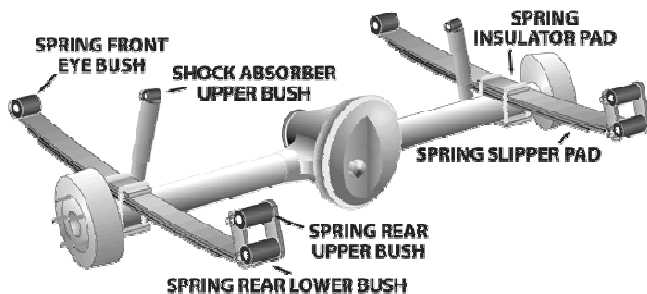
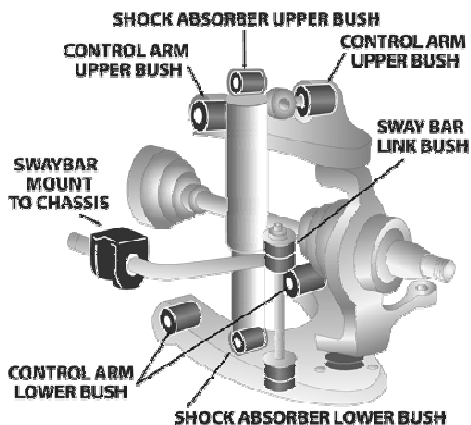

**MITSUBISHI Challenger / Montero Sport / Pajero Sport PA1...**

Página 2 (Continúa)







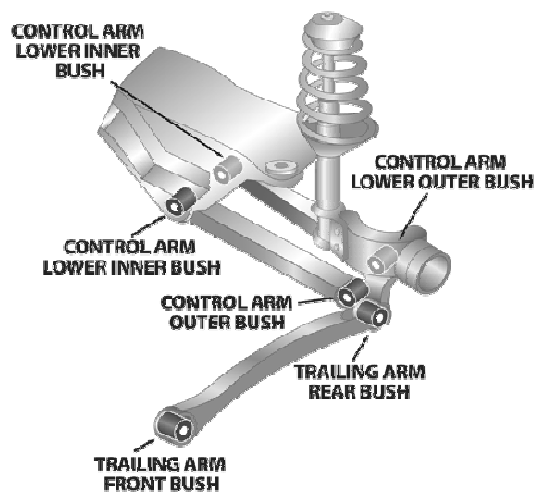
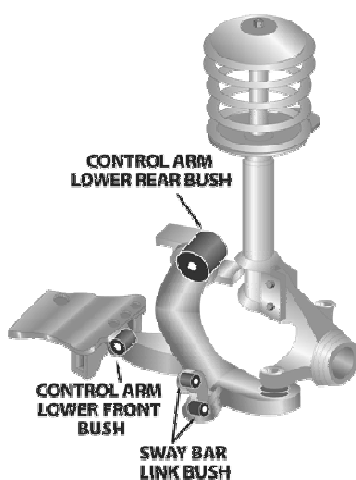

Aplicaci...	Descripción	Referencia	Kits por...	Contenido del Kit	
TRAS.	Sway Bar Mount Bushing Measure bar diameter 18,20,23,24,25,26,27,28mmavailable	MPU-0343-__K	1	Bushings	

## MITSUBISHI 380 Sedan - 9/2005 - 2008

Página 1



Aplicaci...	Descripción	Referencia	Kits por...	Contenido del Kit	
DEL.	Control Arm Lower-Inner Front Kit	<b>MPU-3082K</b>	1	Inner Tubes, Bushings	
DEL.	Control Arm Lower-Inner Rear Eccentric 1 x Standard & 1 x Offset bushing for alignment correction	<b>MPU-3084K</b>	1	Outer Shells, Inner Tubes, Bushings	
DEL.	Control Arm Lower-Inner Rear Eccentric Double offset kit, for alignment correction	<b>MPU-3085K</b>	1	Outer Shells, Inner Tubes, Bushings	
DEL.	Control Arm Lower-Inner Rear Kit Standard replacement	<b>MPU-3083K</b>	1	Outer Shells, Inner Tubes, Bushings	
DEL.	Sway Bar Mount Bushing Measure bar diameter 23mm available, replaces OE# MN101834	<b>MPU-3078-__K</b>	1	Bushings	



## MITSUBISHI Outlander ZG Wagon - 11/2007 - Current

Página 1

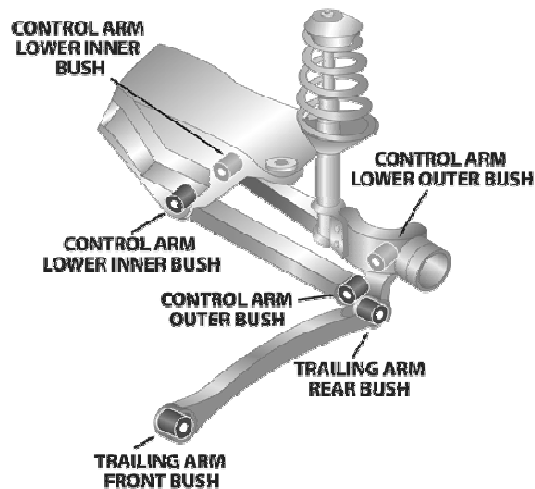
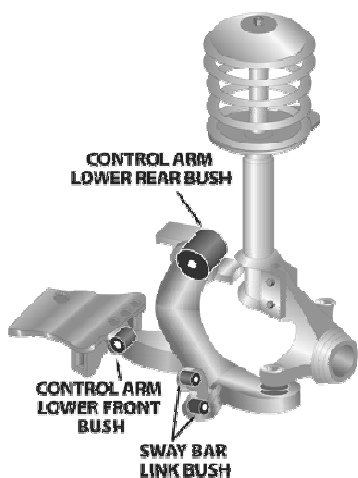

Aplicaci...	Descripción	Referencia	Kits por...	Contenido del Kit	
DEL.	Control Arm Lower-Inner Rear Eccentric 2 x Offset bushings	<b>MPU-3113K</b>	1	Outer Shells, Inner Tubes, Bushings	
DEL.	Control Arm Lower-Inner Rear Eccentric 1 x Offset & 1 x Standard bushing.	<b>MPU-3112K</b>	1	Outer Shells, Inner Tubes, Bushings	
DEL.	Control Arm Lower-Inner Rear Kit - Standard replacement	<b>MPU-3111K</b>	1	Outer Shells, Inner Tubes, Bushings	
TRAS.	Toe Control Arm - Inner Bushing	<b>MPU-2291K</b>	1	Outer Shells, Inner Tubes, Bushings	
TRAS.	Toe Control Arm - Outer Bushing	<b>MPU-2291K</b>	1	Outer Shells, Inner Tubes, Bushings	







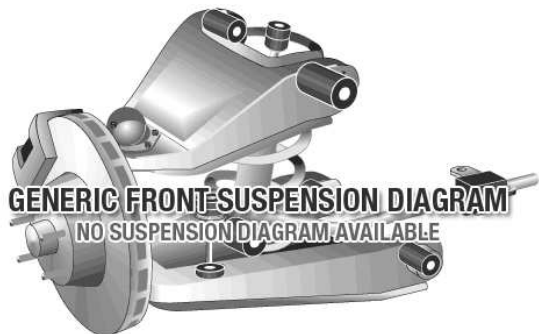

MITSUBISHI Outlander ZE Wagon 2/2003 - 2006 -

Página 1





Aplicaci...	Descripción	Referencia	Kits por...	Contenido del Kit	
DEL.	Control Arm Lower-Inner Rear Eccentric 1 x Offset & 1 x Standard bushing.	<b>MPU-3112K</b>	1	Outer Shells, Inner Tubes, Bushings	
DEL.	Control Arm Lower-Inner Rear Eccentric 2 x Offset bushings.	<b>MPU-3113K</b>	1	Outer Shells, Inner Tubes, Bushings	
DEL.	Control Arm Lower-Inner Rear Kit Standard replacement.	<b>MPU-3111K</b>	1	Outer Shells, Inner Tubes, Bushings	
TRAS.	Differential Support Bracket Mount Kit Replaces OE # MR594994	<b>MPU-2544K</b>	1	Outer Shells, Inner Tubes, Bushings	 SPF2544K

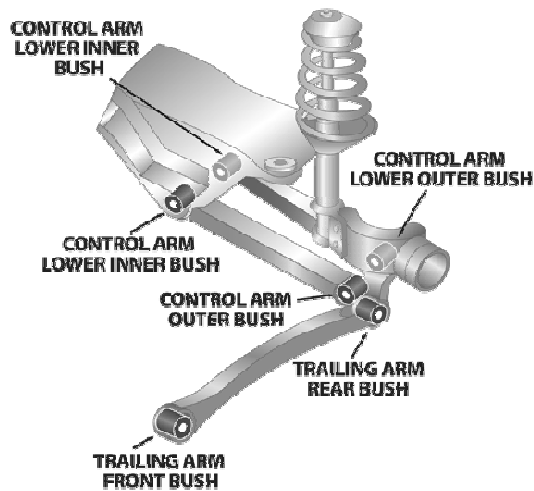
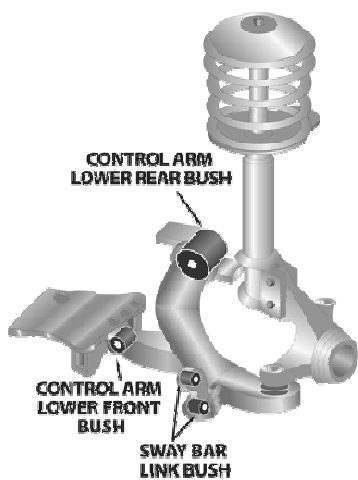

**MITSUBISHI Legnum Wagon - 1996 - On**

Página 1









Aplicaci...	Descripción	Referencia	Kits por...	Contenido del Kit	
DEL.	Sway Bar Mount Bushing Measure bar diameter 24mm available	MPU-3562-__K	1	Bushings	

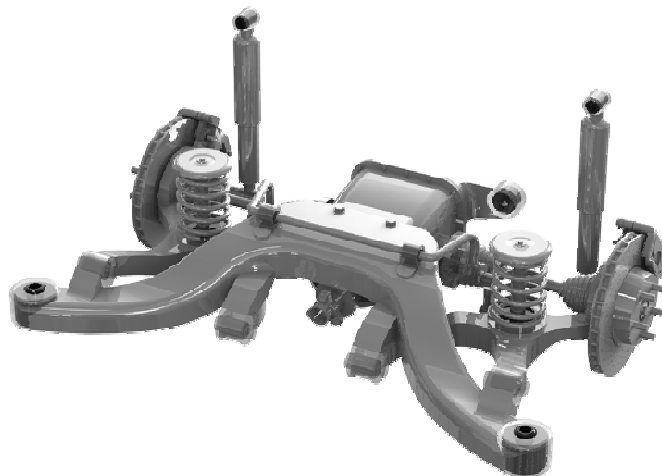
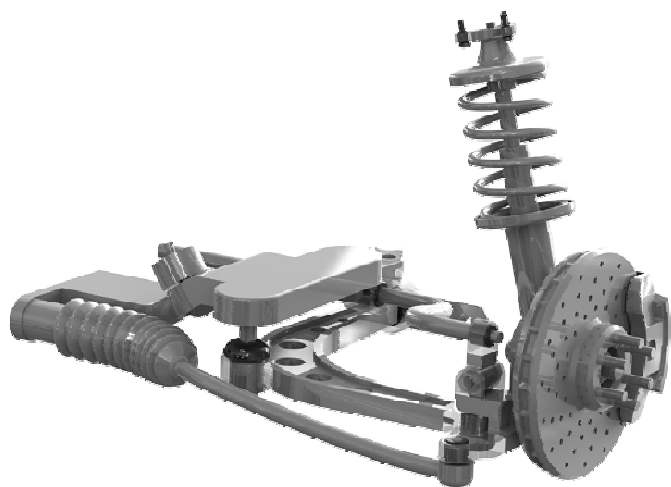

## MITSUBISHI Cordia AA, AB, AC Hatch / Tredia Sedan - 4/1983...

Página 1



Aplicaci...	Descripción	Referencia	Kits por...	Contenido del Kit	
DEL.	Control Arm Lower-Inner Bushing Re-use original shell	<b>MPU-1020K</b>	1	Inner Tubes, Bushings	
DEL.	Strut Bar To Chassis Mount Kit	<b>MPU-0448K</b>	1	Inner Tubes, Bushings	
DEL.	Sway Bar Link To Chassis Bushing	<b>MPU-2092BK</b>	1	Bushings	
DEL.	Sway Bar Mount To Chassis Bushing Measure bar diameter 26mm available	<b>MPU-1021-__K</b>	1	Bushings	
DEL.	Sway Bar To Strut Arm D Bushing	<b>MPU-1022K</b>	1	Bushings	



**MITSUBISHI Galant GA, GB, GC, GD Sedan - 1971 - 1976**

Página 1

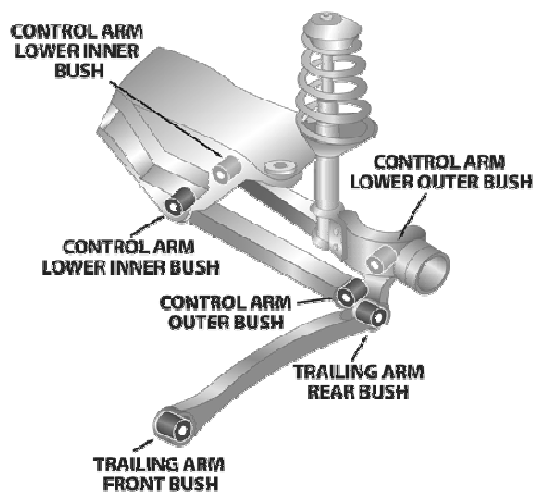
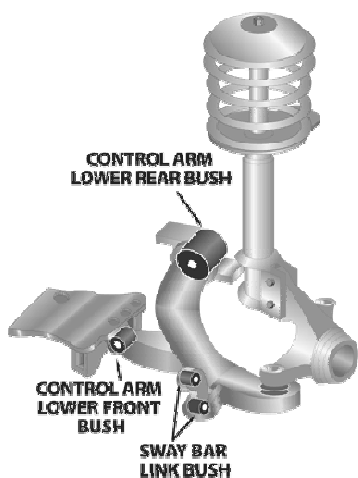







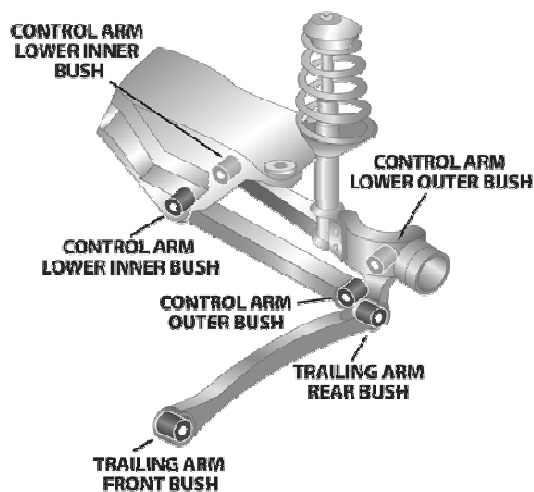
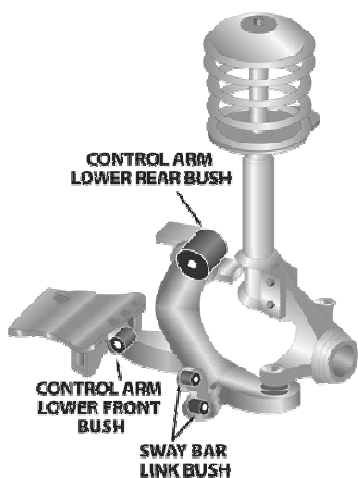

Aplicaci...	Descripción	Referencia	Kits por...	Contenido del Kit	
DEL.	Idler Arm Bushing Tapered style bush	<b>MPU-0602K</b>	1	Bushings	
DEL.	Sway Bar Link Bushing Kit	<b>MPU-0903K</b>	1	Bushings	
TRAS.	Spring Front Eye Bushing 45 OD bush	<b>MPU-0582K</b>	1	Bushings	
TRAS.	Spring Front Eye Bushing 55.5mm OD bush	<b>MPU-1204K</b>	1	Bushings	
TRAS.	Spring Rear Bushing All	<b>MPU-0583K</b>	1	Bushings	



MITSUBISHI Galant HG, HH Sedan & Hatchback - 5/1989 -...

Página 1









Aplicaci...	Descripción	Referencia	Kits por...	Contenido del Kit	
DEL.	Sway Bar Mount To Chassis Bushing Measure bar diameter 17,18,19,20,21,22mm available	MPU-1343-__K	1	Bushings	
DEL.	Control Arm Lower Rear Bushing PS & DS standard	MPU-1313K	1	Bushings	
DEL.	Control Arm Lower Rear Bushing PS increased DS standard caster	MPU-1314K	1	Bushings	
DEL.	Control Arm Lower Rear Bushing PS & DS increased caster	MPU-1315AK	1	Bushings	
DEL.	Control Arm Lower Rear Bushing PS increased DS decrease caster	MPU-1315K	1	Bushings	
DEL.	Control Arm Lower-Front Bushing 31mm OD 12.3mm tube ID	MPU-1437K	1	Bushings, Inner Tubes	
TRAS.	Panhard Rod Bushing Sedan	MPU-0427K	2	Bushings, Inner Tubes	

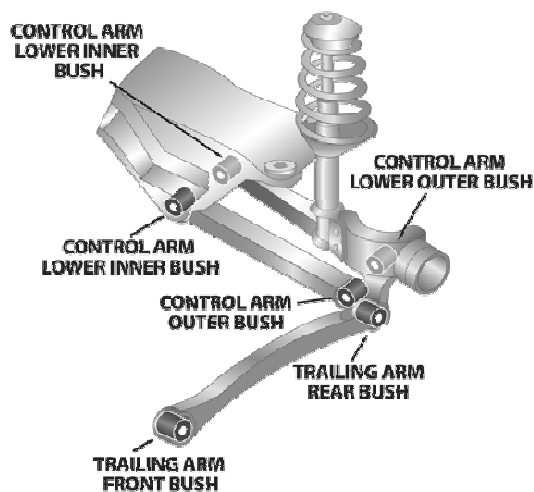
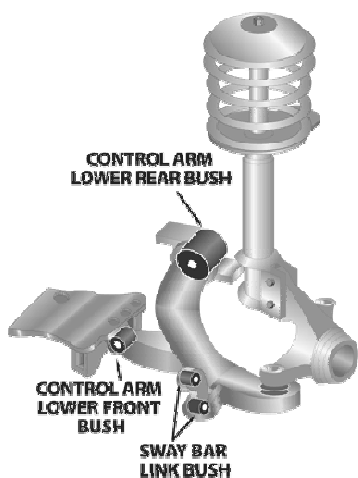

## MITSUBISHI Galant HG, HH Sedan & Hatchback - 5/1989 - ...

Página 2 (Continúa)









Aplicaci...	Descripción	Referencia	Kits por...	Contenido del Kit	
TRAS.	Sway Bar Mount To Chassis Bushing Measure bar diameter 16,18,19,20 & 22mm available	MPU-1344-__K	1	Bushings	
TRAS.	Trailing Arm Lower Front Bushing Sedan "Must remove OE shell"	MPU-1345K	1	Inner Tubes, Bushings	
TRAS.	Trailing Arm Lower Front Bushing VR4 Only	MPU-1439K	1	Inner Tubes, Bushings	
TRAS.	Control Arm Upper-Inner Kit VR4 , HG to HH ( Use original shell )	MPU-2031K	1	Inner Tubes, Bushings	
TRAS.	Control Arm-Inner Bushing VR4 Only	MPU-1438K	1	Inner Tubes, Bushings	

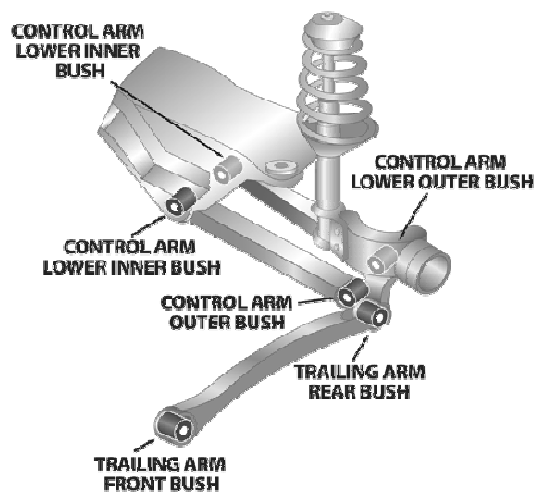
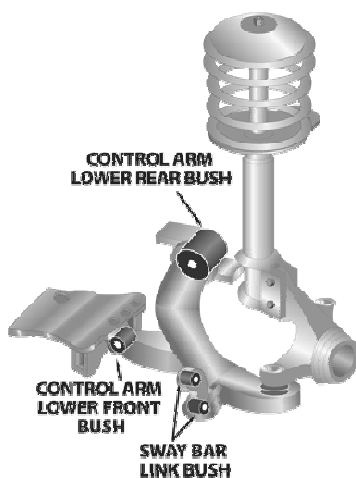

## MITSUBISHI Galant SM5H41 Series - 1996 - 1999

Página 1









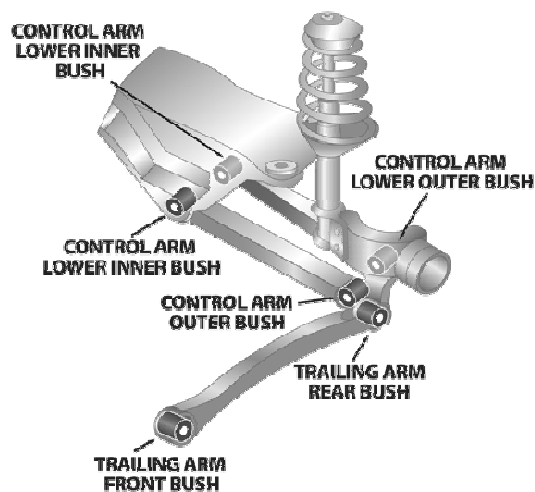
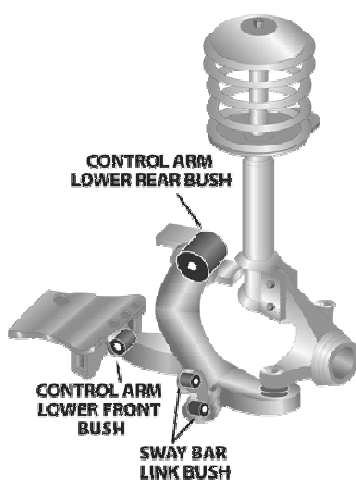

Aplicaci...	Descripción	Referencia	Kits por...	Contenido del Kit	
DEL.	Control Arm Lower-Inner Bushing	<b>MPU-2079K</b>	1	Bushings, Inner Tubes	
DEL.	Control Arm Lower-Shock Mount Kit	<b>MPU-2107K</b>	1	Bushings, Inner Tubes	
TRAS.	Control Arm Upper-Outer Bushing	<b>MPU-1921K</b>	1	Bushings, Inner Tubes	
TRAS.	Trailing Arm - Front Bushing	<b>MPU-2107K</b>	1	Bushings, Inner Tubes	



## MITSUBISHI Galant HJ Hatchback - 5/1993 - 1996

Página 1



Aplicaci...	Descripción	Referencia	Kits por...	Contenido del Kit	
DEL.	Control Arm Lower-Inner Bushing	<b>MPU-0823-4K</b>	1	Bushings, Inner Tubes	
DEL.	Shock Absorber Lower Bushing	<b>MPU-1342K#R&amp;D</b>	1	Bushings, Inner Tubes	
DEL.	Sway Bar Mount To Chassis Bushing Measure bar diameter 17,18,19,20,21,22mm available	<b>MPU-1343-__K</b>	1	Bushings	
TRAS.	Control Arm Lower-Outer Bushing	<b>MPU-1342K#R&amp;D</b>	1	Bushings, Inner Tubes	
TRAS.	Control Arm Upper-Inner Kit	<b>MPU-2115K</b>	1	Inner Tubes, Bushings	
TRAS.	Control Arm Upper-Outer Bushing	<b>MPU-1921K</b>	1	Bushings, Inner Tubes	







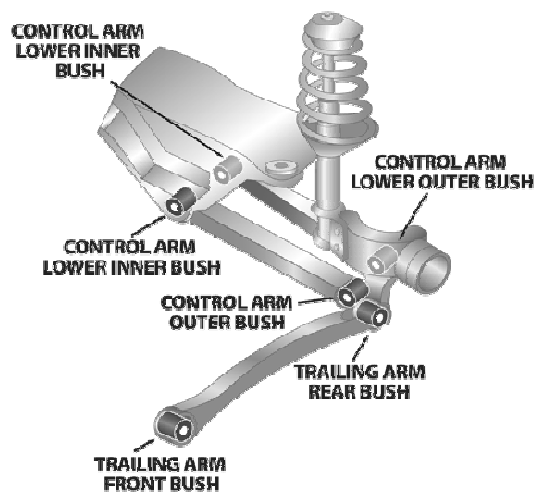
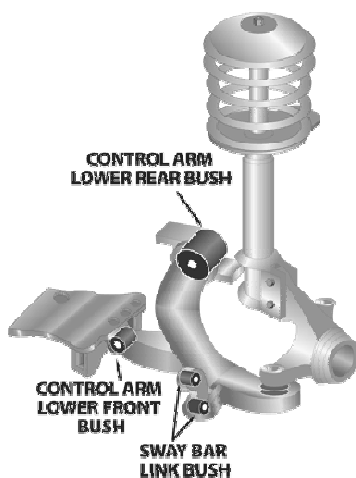

## MITSUBISHI Galant HJ Hatchback - 5/1993 - 1996

Página 2 (Continúa)









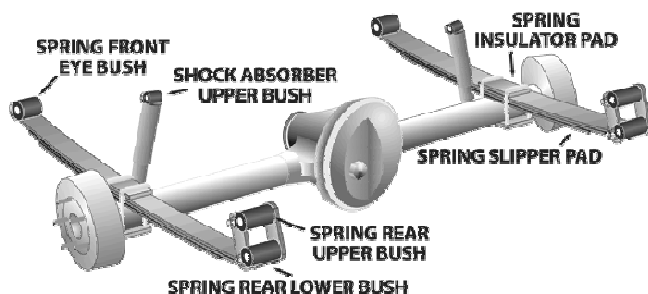
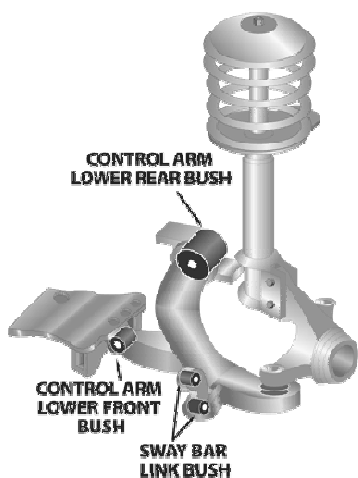

Aplicaci...	Descripción	Referencia	Kits por...	Contenido del Kit	
TRAS.	Sway Bar Mount To Chassis Bushing Measure bar diameter 16,18,19,20 & 22mm available	MPU-1344-__K	1	Bushings	
TRAS.	Trailing Arm Lower Front Bushing	MPU-2117K	1	Inner Tubes, Bushings	
TRAS.	Trailing Arm Lower Rear Bushing Bush in hub assembly	MPU-2114K	1	Outer Shells, Bushings	



## MITSUBISHI Lancer CA, CB Sedan - 9/1988 - 9/1992

Página 1









Aplicaci...	Descripción	Referencia	Kits por...	Contenido del Kit	
DEL.	Control Arm Lower-Inner Rear Kit PS increased DS standard caster " Not GSR vehicle "	<b>MPU-1141K</b>	1	Bushings	
DEL.	Control Arm Lower-Front Bushing	<b>MPU-1160K</b>	1	Bushings, Inner Tubes	
DEL.	Control Arm Lower-Inner Rear Kit PS & DS standard caster setting " Not GSR "	<b>MPU-1140K</b>	1	Bushings	
DEL.	Control Arm Lower-Inner Rear Kit PS & DS increased caster " Not GSR vehicle "	<b>MPU-1142AK</b>	1	Bushings	
DEL.	Control Arm Lower-Inner Rear Kit PS increased DS decrease caster " Not GSR "	<b>MPU-1142K</b>	1	Bushings	
DEL.	Control Arm Lower-Inner Rear Kit Standard "CB GSR Only"	<b>MPU-1714K</b>	1	Bushings, Inner Tubes, Outer Shells, Washers	
DEL.	Control Arm Lower-Inner Rear Kit Single offset, "CB GSR Only"	<b>MPU-2025K</b>	1	Washers, Outer Shells, Inner Tubes, Bushings	

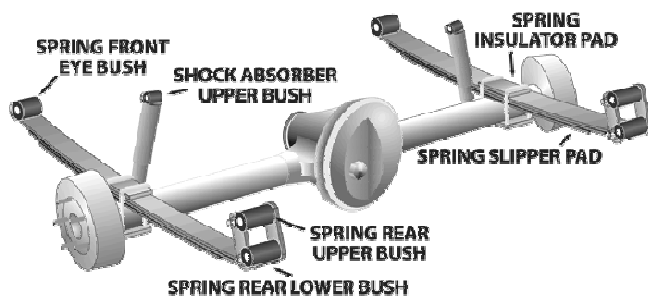
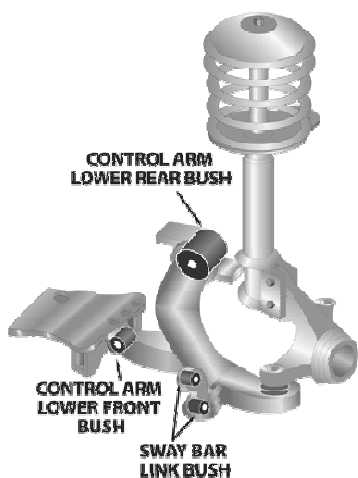

**MITSUBISHI Lancer CA, CB Sedan - 9/1988 - 9/1992**

Página 2 (Continúa)









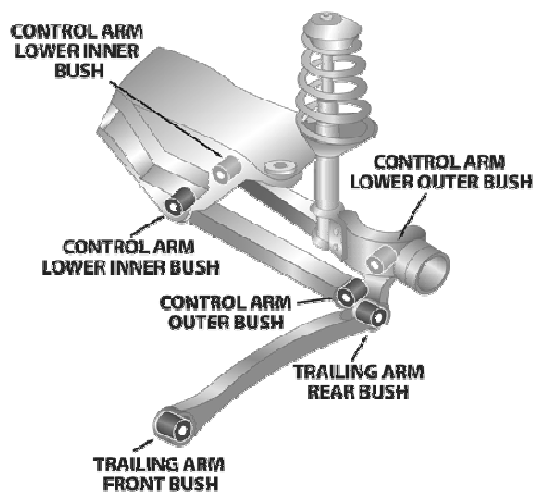
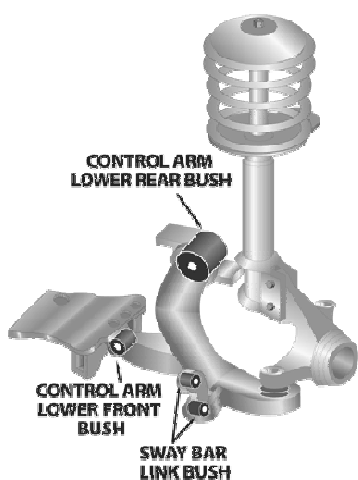

Aplicaci...	Descripción	Referencia	Kits por...	Contenido del Kit	
DEL.	Control Arm Lower-Inner Rear Kit Double offset, "CB GSR Only"	<b>MPU-2026K</b>	1	Washers, Outer Shells, Inner Tubes, Bushings	
DEL.	Sway Bar Link Bushing Kit	<b>MPU-2092BK</b>	1	Bushings	
TRAS.	Panhard Rod Bushing	<b>MPU-0427K</b>	2	Bushings, Inner Tubes	
TRAS.	Sway Bar Link Bushing Kit	<b>MPU-2092BK</b>	1	Bushings	

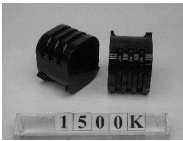

## MITSUBISHI Lancer CE Sedan & Coupe - 7/1996 - 9/1998

Página 1





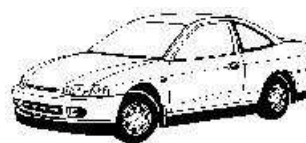



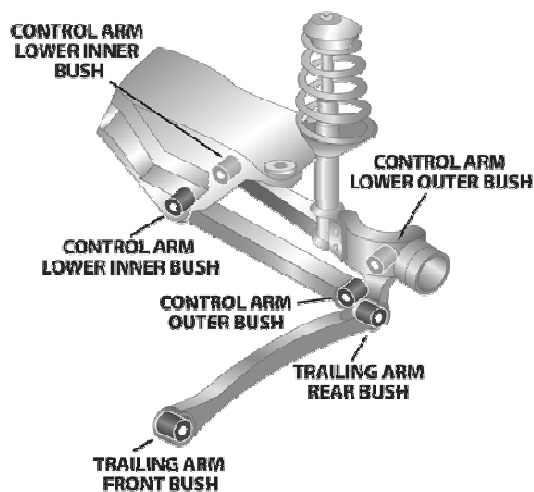
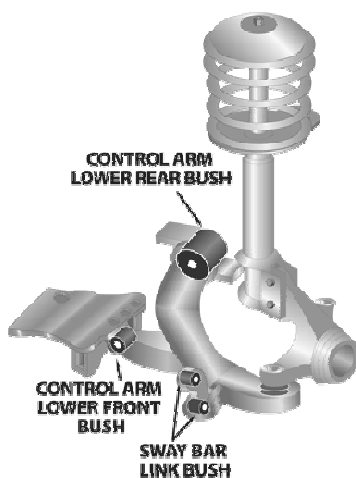

Aplicaci...	Descripción	Referencia	Kits por...	Contenido del Kit	
DEL.	Control Arm Lower Rear Bushing PS & DS standard	<b>MPU-1500K</b>	1	Bushings	
DEL.	Control Arm Lower Rear Bushing PS increased DS standard caster	<b>MPU-1501K</b>	1	Bushings	
DEL.	Control Arm Lower Rear Bushing PS & DS increased caster	<b>MPU-1502AK</b>	1	Bushings	
DEL.	Control Arm Lower Rear Bushing PS increased DS decrease caster	<b>MPU-1502K</b>	1	Bushings	
DEL.	Control Arm Lower Rear Bushing Anti lift kit maximum caster	<b>MPU-1502XK</b>	1	Bushings	
DEL.	Control Arm-Inner Front Bushing	<b>MPU-1160K</b>	1	Bushings, Inner Tubes	
DEL.	Sway Bar Mount To Chassis Bushing Measure bar diameter 18,20,22,23,24mm available	<b>MPU-1572-__K</b>	1	Bushings	



## MITSUBISHI Lancer CE Sedan & Coupe - 7/1996 - 9/1998

Página 2 (Continúa)



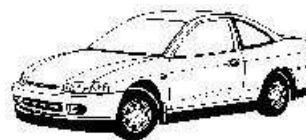

Aplicaci...	Descripción	Referencia	Kits por...	Contenido del Kit	
TRAS.	Control Arm Lower-Inner & Outer Kit	<b>MPU-1573K</b>	1	Outer Shells, Inner Tubes, Bushings	
TRAS.	Control Arm Upper-Inner Kit Kit includes mounting foot pin	<b>MPU-2110K</b>	1	Pin, Outer Shells, Bushings	
TRAS.	Control Arm Upper-Outer Bushing	<b>MPU-2291K</b>	1	Outer Shells, Inner Tubes, Bushings	
TRAS.	Lateral Arm Front Inner Bushing Replaces hyme joint type bush with 40.25mm OD bush	<b>MPU-2027K</b>	1	Inner Tubes, Bushings	
TRAS.	Lateral Arm Front Outer Bushing Kit includes mounting foot pin	<b>MPU-2110K</b>	1	Pin, Outer Shells, Bushings	
TRAS.	Sway Bar Link Bushing Kit	<b>MPU-2292BK</b>	1	Washers, Bushings	
TRAS.	Sway Bar Mount To Chassis Bushing Bar diameter 12,13,15,16,18,19,20,22mm ava,32mm wide bracket	<b>MPU-1826-__K</b>	1	Bushings	

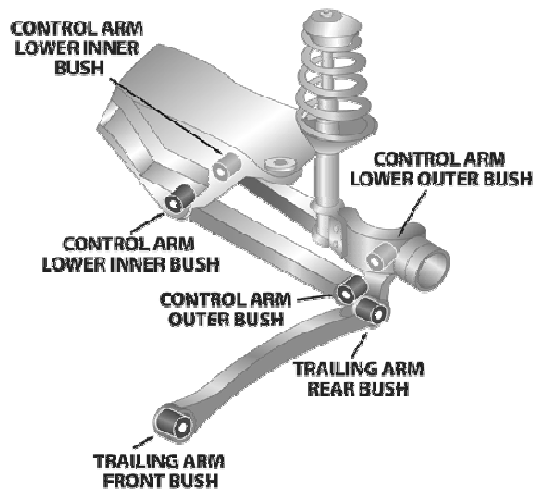
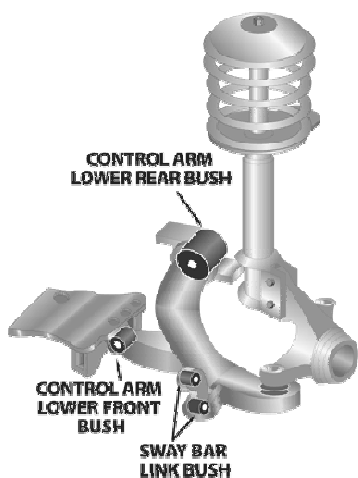

**mitsubishi Lancer CE Sedan & Coupe - 7/1996 - 9/1998**

Página 3 (Continúa)









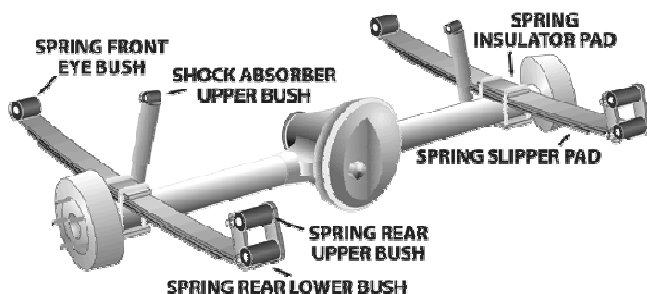
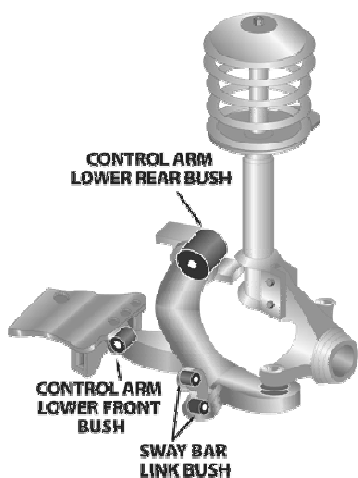

Aplicaci...	Descripción	Referencia	Kits por...	Contenido del Kit	
TRAS.	Trailing Arm - Front Bushing	MPU-1574K	1	Inner Tubes, Bushings	



## MITSUBISHI Lancer LA, LB, LC - 1974 - 1981

Página 1





Aplicaci...	Descripción	Referencia	Kits por...	Contenido del Kit	
DEL.	Control Arm Lower-Inner Bushing OE# MB 001621 ( Tapered bush )	<b>MPU-0154K</b>	1	Bushings	 0154K
DEL.	Idler Arm Bushing Tapered style bush	<b>MPU-0602K</b>	1	Bushings	 0602K
DEL.	Idler Arm Bushing LHS only. Straight style bush	<b>MPU-1288K</b>	1	Bushings	
DEL.	Strut Bar To Chassis Mount Kit	<b>MPU-0184K</b>	1	Bushings	 0184K
DEL.	Sway Bar Link Bushing Kit	<b>MPU-2092BK</b>	1	Bushings	 SPF2092BK
TRAS.	Spring Front Eye Bushing 45 OD bush	<b>MPU-0582K</b>	1	Bushings	 582K
TRAS.	Spring Front Eye Bushing 55.5mm OD bush	<b>MPU-1204K</b>	1	Bushings	 1204K

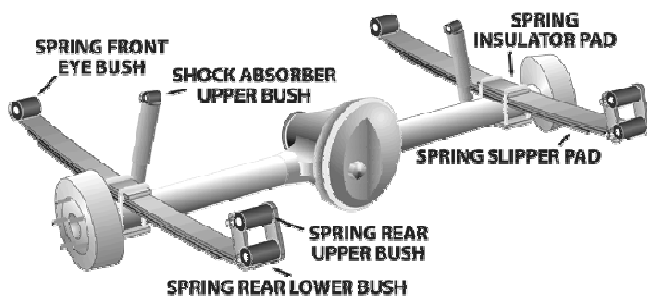
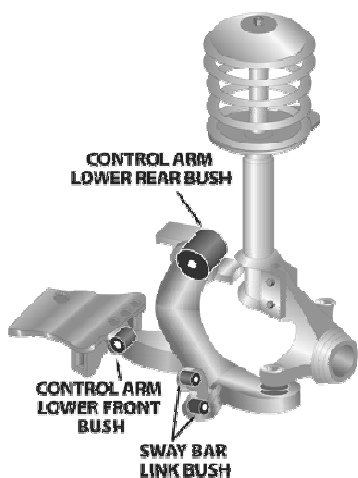

**MITSUBISHI Lancer LA, LB, LC - 1974 - 1981**

Página 2 (Continúa)



Aplicaci...	Descripción	Referencia	Kits por...	Contenido del Kit	
TRAS.	Spring Rear Eye Bushing	MPU-0583K	1	Bushings	 0 5 8 3 K









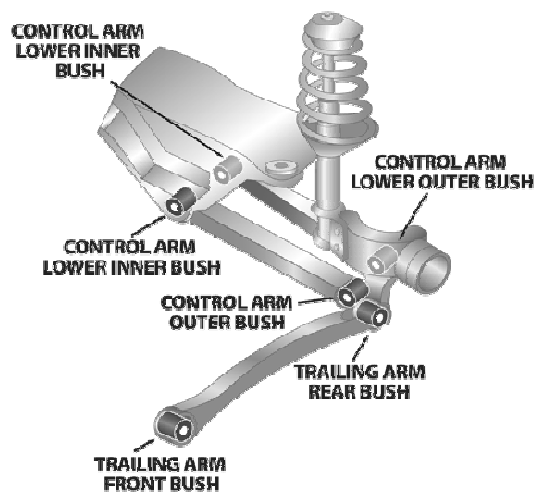
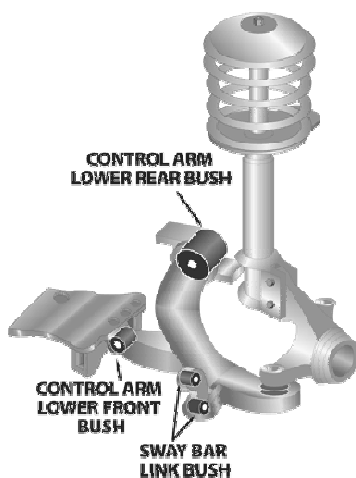



## MITSUBISHI Lancer CC Sedan & Coupe - 10/1992 - 5/1996

Página 1









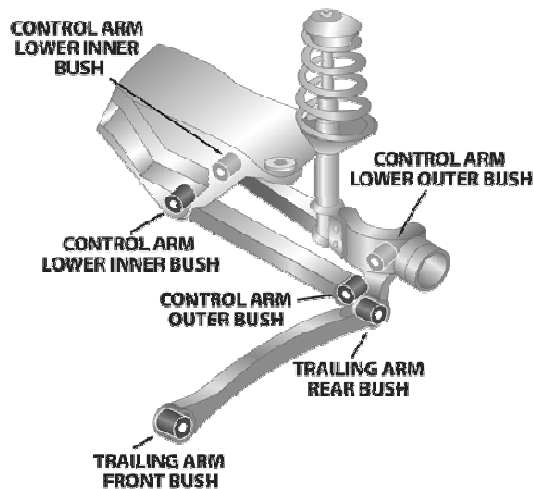
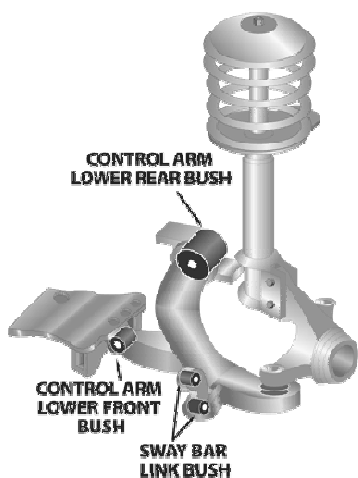

Aplicaci...	Descripción	Referencia	Kits por...	Contenido del Kit	
DEL.	Control Arm Lower Rear Bushing PS & DS standard	<b>MPU-1500K</b>	1	Bushings	
DEL.	Control Arm Lower Rear Bushing PS increased DS standard caster	<b>MPU-1501K</b>	1	Bushings	
DEL.	Control Arm Lower Rear Bushing PS & DS increased caster	<b>MPU-1502AK</b>	1	Bushings	
DEL.	Control Arm Lower Rear Bushing PS increased DS decrease caster	<b>MPU-1502K</b>	1	Bushings	
DEL.	Control Arm Lower Rear Bushing Anti lift kit maximum caster	<b>MPU-1502XK</b>	1	Bushings	
DEL.	Control Arm-Inner Front Bushing	<b>MPU-1160K</b>	1	Bushings, Inner Tubes	
DEL.	Steering Rack & Pinion Mount Bushing Not EVO series	<b>MPU-1706K</b>	1	Bushings	



## MITSUBISHI Lancer CC Sedan & Coupe - 10/1992 - 5/1996

Página 2 (Continúa)





Aplicaci...	Descripción	Referencia	Kits por...	Contenido del Kit	
DEL.	Sway Bar Link Bushing Kit	MPU-2092BK	1	Bushings	
DEL.	Sway Bar Mount To Chassis Bushing Measure bar diameter 18,20,22,23,24mm available	MPU-1572-__K	1	Bushings	
TRAS.	Sway Bar Mount To Chassis Bushing Bar diameter 12,13,15,16,18,19,20,22mm ava,32mm wide bracket	MPU-1826-__K	1	Bushings	
TRAS.	Control Arm Lower-Inner & Outer Kit	MPU-1573K	1	Outer Shells, Inner Tubes, Bushings	
TRAS.	Panhard Rod Bushing	MPU-0427K	2	Bushings, Inner Tubes	
TRAS.	Sway Bar Link Bushing Kit	MPU-2092BK	1	Bushings	
TRAS.	Sway Bar Mount Bushing Note	MPU-0738-__K	1	Bushings	

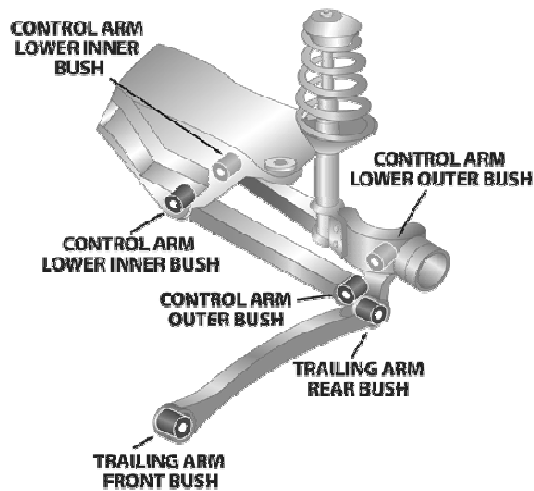
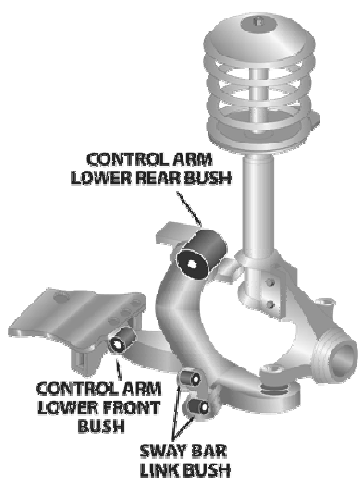

**MITSUBISHI Lancer CC Sedan & Coupe - 10/1992 - 5/1996**

Página 3 (Continúa)









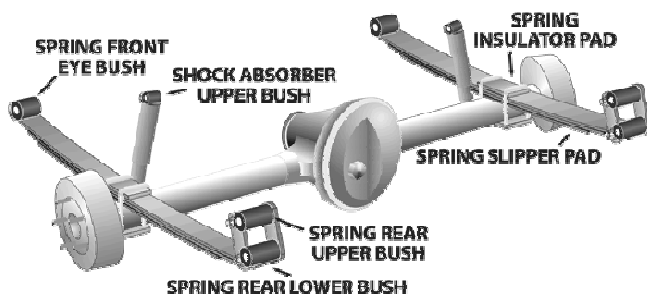
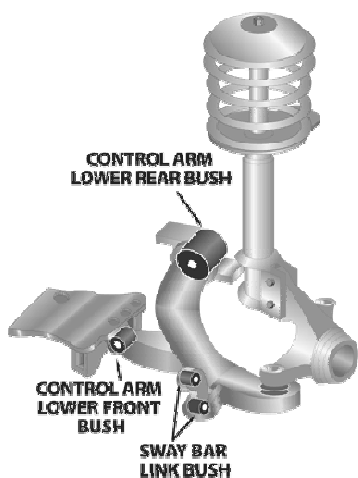

Aplicaci...	Descripción	Referencia	Kits por...	Contenido del Kit	
TRAS.	Trailing Arm - Front Bushing	<b>MPU-1574K</b>	1	Inner Tubes, Bushings	

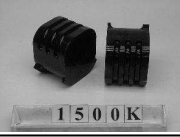

## MITSUBISHI Lancer CE Series II Sedan & Coupe - 9/1998 - 2004

Página 1





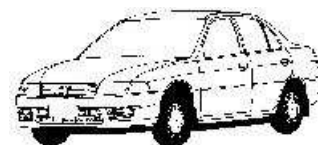



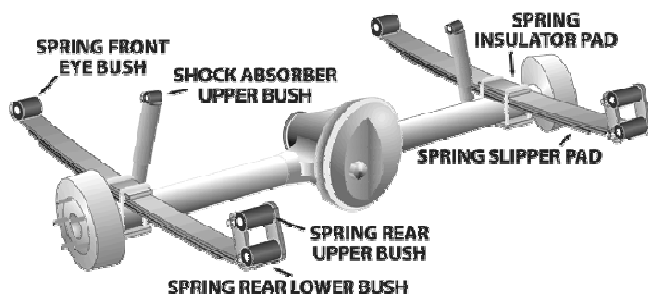
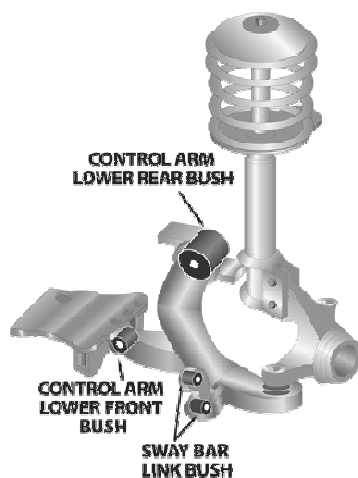

Aplicaci...	Descripción	Referencia	Kits por...	Contenido del Kit	
DEL.	Control Arm Lower-Inner Rear Kit PS & DS increased caster	<b>MPU-1502AK</b>	1	Bushings	
DEL.	Control Arm Lower-Inner Front Kit	<b>MPU-1160K</b>	1	Bushings, Inner Tubes	
DEL.	Control Arm Lower-Inner Rear Kit PS & DS standard	<b>MPU-1500K</b>	1	Bushings	
DEL.	Control Arm Lower-Inner Rear Kit PS increased DS standard caster	<b>MPU-1501K</b>	1	Bushings	
DEL.	Control Arm Lower-Inner Rear Kit PS increased DS decrease caster	<b>MPU-1502K</b>	1	Bushings	
DEL.	Control Arm Lower-Inner Rear Kit Anti lift kit maximum caster	<b>MPU-1502XK</b>	1	Bushings	
DEL.	Steering Rack & Pinion Mount Bush.....Power Steering	<b>MPU-1706K</b>	1	Bushings	



## MITSUBISHI Lancer CE Series II Sedan & Coupe - 9/1998 - 2004

Página 2 (Continúa)









Aplicaci...	Descripción	Referencia	Kits por...	Contenido del Kit	
DEL.	Sway Bar Link Bushing Kit	MPU-2292BK	1	Washers, Bushings	
DEL.	Sway Bar Mount To Chassis Bushing Measure bar diameter 18,20,22,23,24mm available	MPU-1572-__K	1	Bushings	
TRAS.	Control Arm Lower-Inner & Outer Kit	MPU-1573K	1	Outer Shells, Inner Tubes, Bushings	
TRAS.	Control Arm Upper-Inner Kit Kit includes mounting foot pin	MPU-2110K	1	Pin, Outer Shells, Bushings	
TRAS.	Control Arm Upper-Outer Bushing	MPU-2291K	1	Outer Shells, Inner Tubes, Bushings	
TRAS.	Lateral Arm Front Inner Bushing Replaces hyme joint type bush with 40.25mm OD bush	MPU-2027K	1	Inner Tubes, Bushings	
TRAS.	Lateral Arm Front Inner Bushing Replaces hyme joint type bush with 36.05mm OD shell	MPU-2291K	1	Outer Shells, Inner Tubes, Bushings	

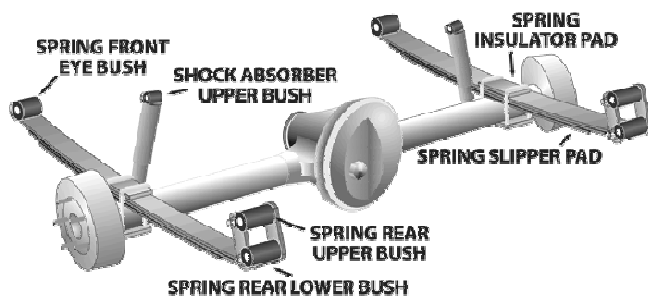
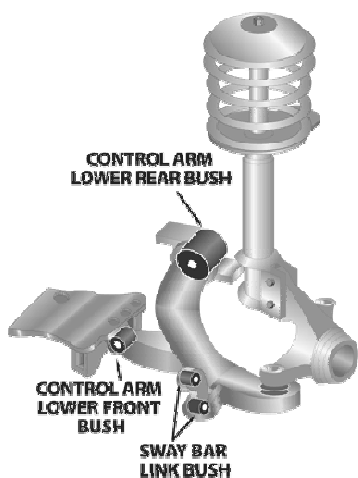

## MITSUBISHI Lancer CE Series II Sedan & Coupe - 9/1998 - 2004

Página 3 (Continúa)









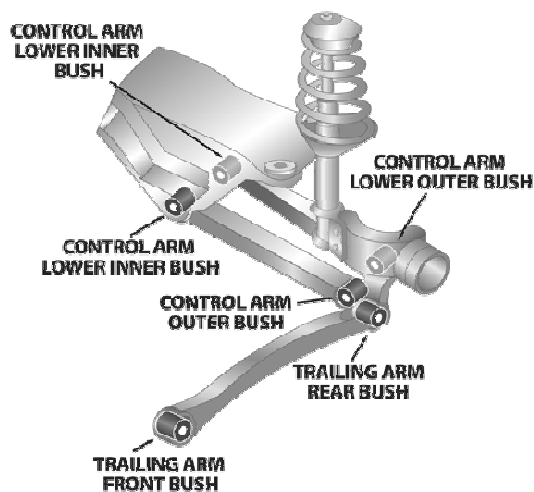
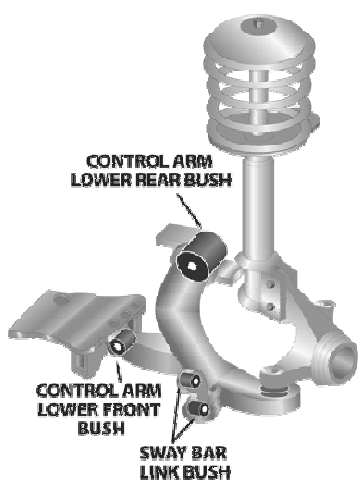

Aplicaci...	Descripción	Referencia	Kits por...	Contenido del Kit	
TRAS.	Lateral Arm Front Outer Bushing Kit includes mounting foot pin	<b>MPU-2110K</b>	1	Pin, Outer Shells, Bushings	
TRAS.	Sway Bar End Link Bushing	<b>MPU-2092B-4K</b>	1	Bushings	
TRAS.	Sway Bar Mount To Chassis Bushing Bar diameter 12,13,15,16,18,19,20,22mm ava,32mm wide bracket	<b>MPU-1826-__K</b>	1	Bushings	
TRAS.	Trailing Arm - Front Bushing	<b>MPU-1574K</b>	1	Inner Tubes, Bushings	

## MITSUBISHI Lancer CH Sedan - 10/2003 - 9/2007

Página 1





Aplicaci...	Descripción	Referencia	Kits por...	Contenido del Kit	
DEL.	Control Arm Lower-Inner Front Kit 12mm Mounting Bolt	<b>MPU-1715K</b>	1	Inner Tubes, Bushings	
DEL.	Control Arm Lower-Inner Front Kit 14mm Mounting bolt	<b>MPU-1715-14K</b>	1	Inner Tubes, Bushings	
DEL.	Control Arm Lower-Inner Rear Eccentric 1 x Offset & 1 x Standard bushing.	<b>MPU-3112K</b>	1	Outer Shells, Inner Tubes, Bushings	
DEL.	Control Arm Lower-Inner Rear Eccentric 2 x Offset bushings.	<b>MPU-3113K</b>	1	Outer Shells, Inner Tubes, Bushings	
DEL.	Control Arm Lower-Inner Rear Kit Standard replacement.	<b>MPU-3111K</b>	1	Outer Shells, Inner Tubes, Bushings	
DEL.	Sway Bar Link Bushing Kit	<b>MPU-2292BK</b>	1	Washers, Bushings	
DEL.	Sway Bar Mount Bushing Measure bar diameter, 24,25,26,27,28,29,30mm available	<b>MPU-1451-__K</b>	1	Bushings	

**mitsubishi Lancer CH Sedan - 10/2003 - 9/2007**

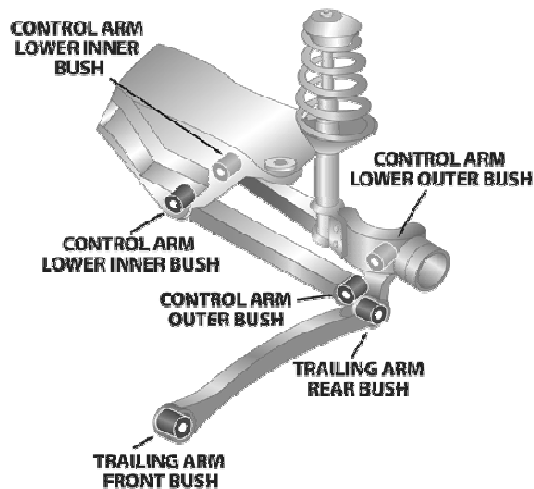
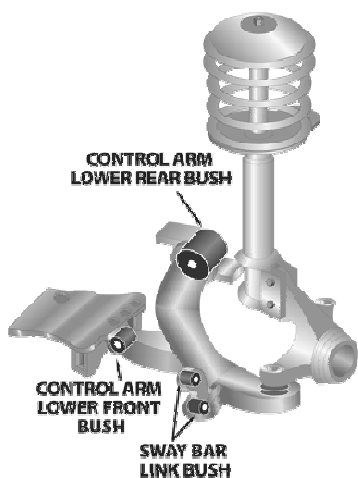
Página 2 (Continúa)



Aplicaci...	Descripción	Referencia	Kits por...	Contenido del Kit	
TRAS.	Lateral Arm Front Bushing Inner & Outer bush kits	<b>MPU-2114K</b>	2	Outer Shells, Bushings	





## MITSUBISHI Lancer CJ Sedan - 10/2007 - Current

Página 1

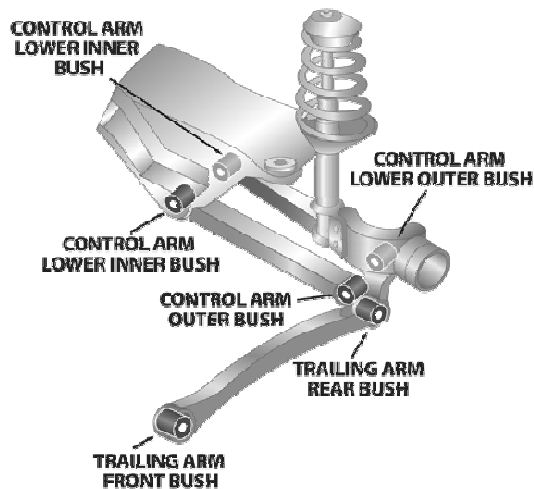
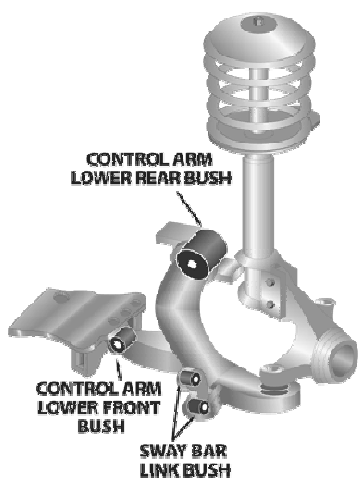

Aplicaci...	Descripción	Referencia	Kits por...	Contenido del Kit	
DEL.	Control Arm Lower-Inner Rear Eccentric 2 x Offset bushings	<b>MPU-3113K</b>	1	Outer Shells, Inner Tubes, Bushings	
DEL.	Control Arm Lower-Inner Rear Eccentric 1 x Offset & 1 x Standard bushing	<b>MPU-3112K</b>	1	Outer Shells, Inner Tubes, Bushings	
DEL.	Control Arm Lower-Inner Rear Kit Standard replacement	<b>MPU-3111K</b>	1	Outer Shells, Inner Tubes, Bushings	
TRAS.	Sway Bar Mount To Chassis Bushing Check bar diameter - 23,25,27,27.5 & 28mm	<b>MPU-3362-__K</b>	1	Bushings	
TRAS.	Toe Control Arm - Inner Bushing	<b>MPU-2291K</b>	1	Outer Shells, Inner Tubes, Bushings	
TRAS.	Toe Control Arm - Outer Bushing	<b>MPU-2291K</b>	1	Outer Shells, Inner Tubes, Bushings	



## MITSUBISHI Magna TM - TN - TP - 4/1985 - 2/1991

Página 1

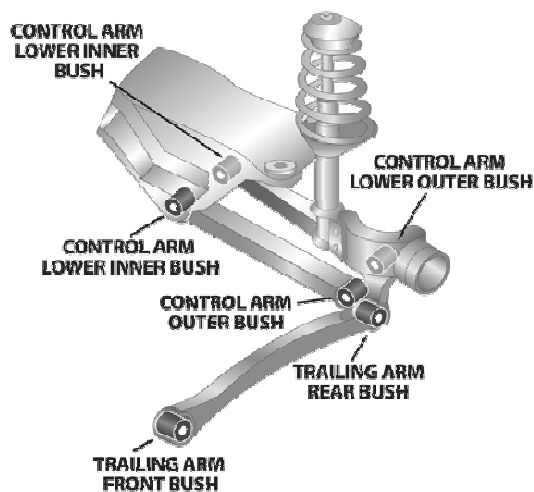
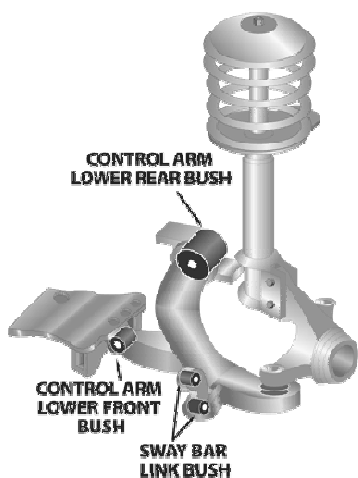

Aplicaci...	Descripción	Referencia	Kits por...	Contenido del Kit	
DEL.	Control Arm Lower Rear Bushing TM to TN 4/1985 to 2/1988 PS & DS standard setting	<b>MPU-0426K</b>	1	Bushings	 0426K
DEL.	Control Arm Lower Rear Bushing TN to TP 3/1988 to 3/1992 PS & DS standard setting	<b>MPU-0577K</b>	1	Bushings	 577K
DEL.	Control Arm Lower Rear Bushing TM to TN 4/1985 to 2/1988 PS increased DS standard	<b>MPU-0651K</b>	1	Bushings	 0651K
DEL.	Control Arm Lower Rear Bushing TN to TP 3/1988 to 3/1992 PS increased DS standard	<b>MPU-0652K</b>	1	Bushings	 0652K
DEL.	Control Arm Lower Rear Bushing TM to TN 4/1985 to 2/1988 PS & DS increased caster	<b>MPU-0787AK</b>	1	Bushings	 0787AK
DEL.	Control Arm Lower Rear Bushing TM to TN 4/1985 to 2/1988 PS increased DS decreased	<b>MPU-0787K</b>	1	Bushings	 0787K
DEL.	Control Arm Lower Rear Bushing TN to TP 3/1988 to 3/1992 PS increased DS decreased	<b>MPU-0788K</b>	1	Bushings	 0788K



## MITSUBISHI Magna TM - TN - TP - 4/1985 - 2/1991

Página 2 (Continúa)

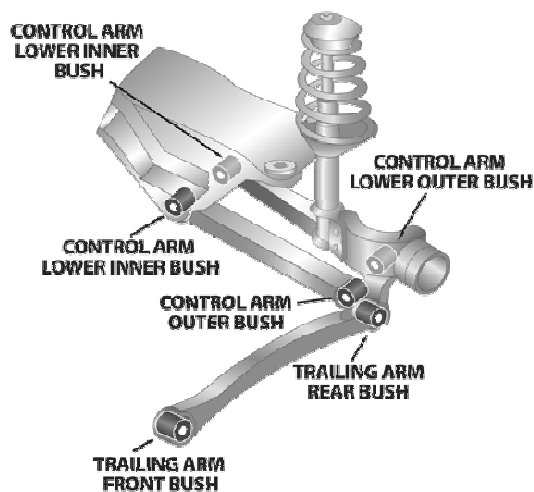
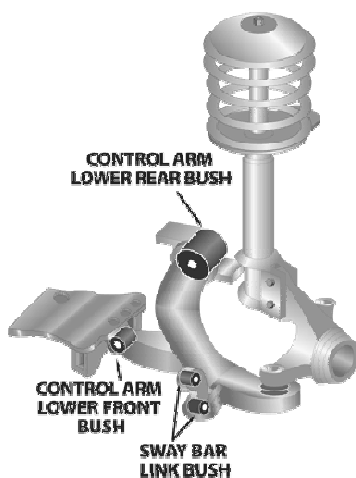

Aplicaci...	Descripción	Referencia	Kits por...	Contenido del Kit	
DEL.	Control Arm Lower Rear-Bracket Mount 7/89 Wagon	<b>MPU-2452K</b>	1	Bushings, Inner Tubes, Washers	
DEL.	Control Arm Lower-Front Bushing	<b>MPU-0576K</b>	1	Inner Tubes, Bushings	
DEL.	Sway Bar Link Bushing Kit	<b>MPU-2092BK</b>	1	Bushings	
DEL.	Sway Bar Mount To Chassis Bushing Measure bar diameter 16,18,19,20mm available	<b>MPU-0162-__K</b>	1	Bushings	
TRAS.	Trailing Arm Upper Bushing All Wagon	<b>MPU-0593K</b>	2	Inner Tubes, Bushings	
TRAS.	Panhard Rod Bushing Sedan	<b>MPU-0427K</b>	2	Bushings, Inner Tubes	
TRAS.	Trailing Arm Lower Diagonal Support Wagon	<b>MPU-0909K</b>	1	Bushings, Inner Tubes	



## MITSUBISHI Magna TM - TN - TP - 4/1985 - 2/1991

Página 3 (Continúa)

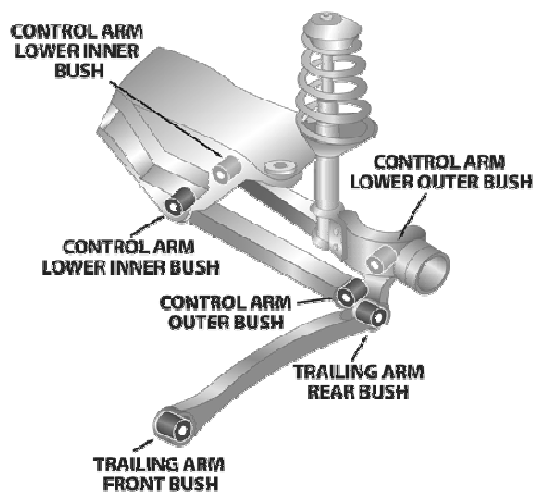
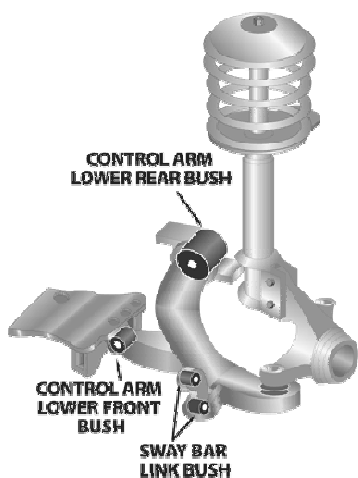







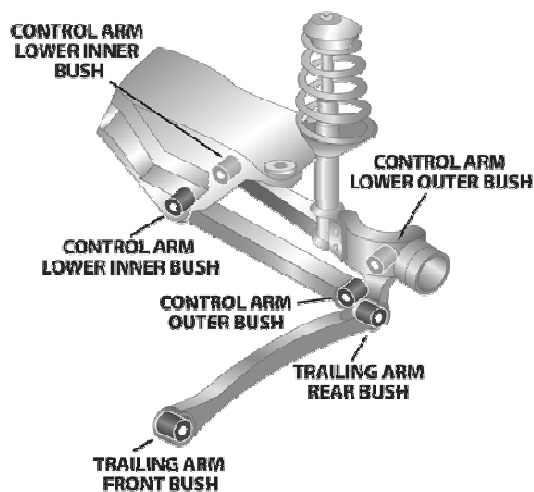
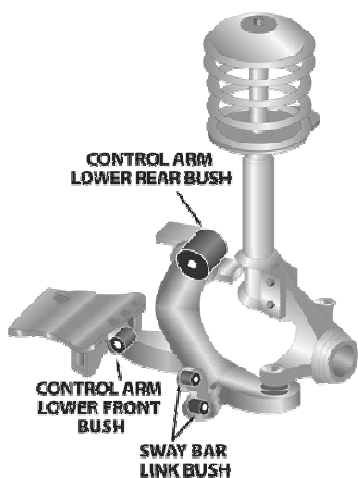

Aplicaci...	Descripción	Referencia	Kits por...	Contenido del Kit	
TRAS.	Trailing Arm Lower Front Bushing Wagon	<b>MPU-0423K</b>	1	Inner Tubes, Bushings	
TRAS.	Trailing Arm Lower Front Bushing Sedan	<b>MPU-1231K</b>	1	Bushings, Inner Tubes	
TRAS.	Trailing Arm Lower Rear Bushing Wagon	<b>MPU-0168K</b>	1	Inner Tubes, Bushings	



## MITSUBISHI Magna TR - TS & KR - KS Verada - 3/1991 - 3/1996

Página 1









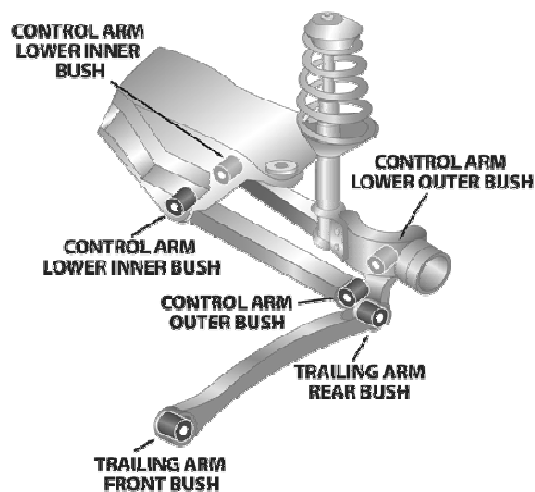
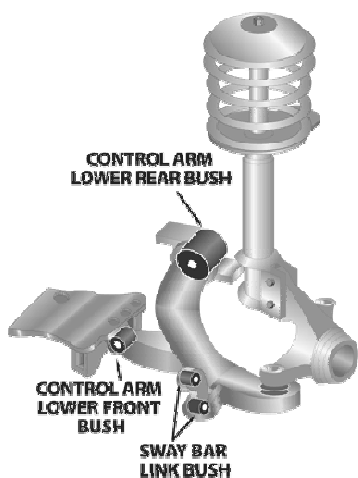

Aplicaci...	Descripción	Referencia	Kits por...	Contenido del Kit	
DEL.	Control Arm Lower Rear Bushing "Slide on mount peg" PS & DS standard setting caster	<b>MPU-1112K</b>	1	Bushings	
DEL.	Control Arm Lower Rear Bushing "Slide on mount peg" PS increased DS standard caster	<b>MPU-1113K</b>	1	Bushings	
DEL.	Control Arm Lower Rear Bushing "Slide on mount peg" PS & DS increased caster	<b>MPU-1114AK</b>	1	Bushings	
DEL.	Control Arm Lower Rear Bushing "Slide on mount peg" PS increase DS decrease caster	<b>MPU-1114K</b>	1	Bushings	
DEL.	Control Arm Lower Rear Bushing "Locking nut on mount peg" PS & DS Standard	<b>MPU-1240K</b>	1	Washers, Outer Shells, Inner Tubes, Bushings	
DEL.	Control Arm Lower Rear Bushing "Locking nut on mount peg" PS Inc / DS Standard	<b>MPU-1241K</b>	1	Bushings, Inner Tubes, Outer Shells, Washers	
DEL.	Control Arm Lower Rear Bushing "Locking nut on mount peg" PS & DS Inc or Dec	<b>MPU-1242K</b>	1	Bushings, Inner Tubes, Outer Shells, Washers	



## MITSUBISHI Magna TR - TS & KR - KS Verada - 3/1991 - 3/1996

Página 2 (Continúa)







Aplicaci...	Descripción	Referencia	Kits por...	Contenido del Kit	
DEL.	Control Arm Lower Rear-Bracket Mount Oct-93	<b>MPU-2451K</b>	1	Bushings, Inner Tubes, Washers	
DEL.	Control Arm Lower-Front Bushing	<b>MPU-1126K</b>	1	Inner Tubes, Bushings	
DEL.	Sway Bar Link Bushing Kit	<b>MPU-2092B-4K</b>	1	Bushings	
DEL.	Sway Bar Mount To Chassis Bushing Measure bar diameter 20, 21, 23, 24mm available	<b>MPU-1257-__K</b>	1	Bushings	
TRAS.	Panhard Rod Bushing Sedan	<b>MPU-0427K</b>	2	Bushings, Inner Tubes	
TRAS.	Trailing Arm Lower Diagonal Support Wagon	<b>MPU-0909K</b>	1	Bushings, Inner Tubes	
TRAS.	Trailing Arm Lower Front Bushing Wagon	<b>MPU-0423K</b>	1	Inner Tubes, Bushings	

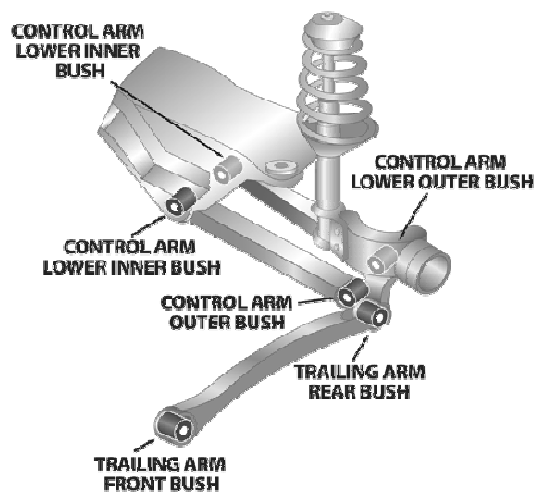
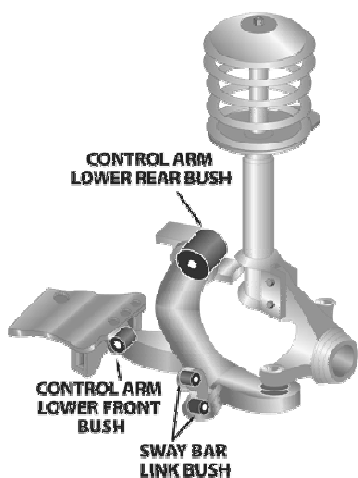

**mitsubishi Magna TR - TS & KR - KS Verada - 3/1991 - 3/1996**

Página 3 (Continúa)









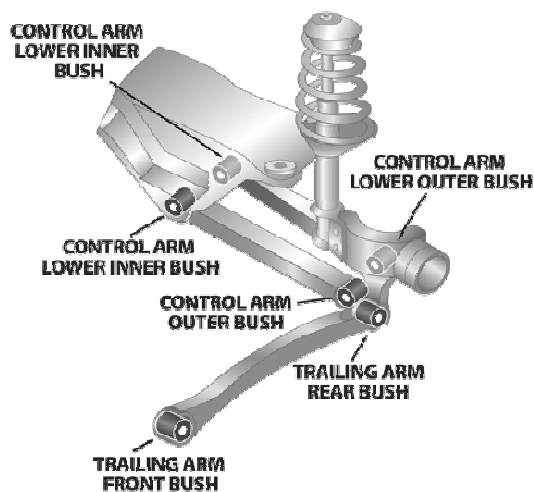
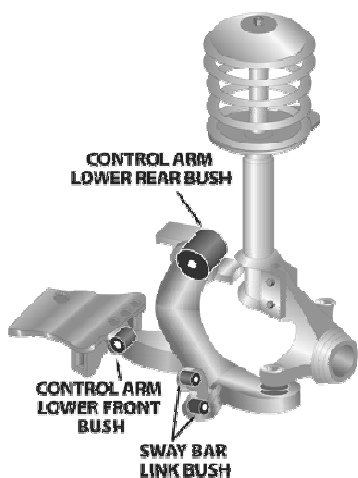

Aplicaci...	Descripción	Referencia	Kits por...	Contenido del Kit	
TRAS.	Trailing Arm Lower Front Bushing Sedan "Must remove OE shell"	<b>MPU-1345K</b>	1	Inner Tubes, Bushings	
TRAS.	Trailing Arm Lower Rear Bushing Wagon	<b>MPU-0168K</b>	1	Inner Tubes, Bushings	
TRAS.	Trailing Arm Upper Bushing All Wagon	<b>MPU-0593K</b>	2	Inner Tubes, Bushings	



## MITSUBISHI Magna TE - TF & KE - KF Verada - 4/1996 - 5/1998

Página 1



Aplicaci...	Descripción	Referencia	Kits por...	Contenido del Kit	
DEL.	Control Arm Lower Rear Bushing "Slide on mount peg" PS & DS standard setting	<b>MPU-1366K</b>	1	Outer Shells, Bushings	
DEL.	Control Arm Lower Rear Bushing "Slide on mount peg" PS increased DS standard	<b>MPU-1367K</b>	1	Outer Shells, Bushings	
DEL.	Control Arm Lower Rear Bushing "Slide on mount peg" PS increased DS decreased	<b>MPU-1368K</b>	1	Outer Shells, Bushings	
DEL.	Control Arm Lower Rear Bushing "Locking nut on mount peg" PS & DS Standard setting	<b>MPU-1999K</b>	1	Washers, Outer Shells, Inner Tubes, Bushings	
DEL.	Control Arm Lower Rear Bushing "Locking nut on mount peg" PS increased DS standard	<b>MPU-2000K</b>	1	Washers, Outer Shells, Inner Tubes, Bushings	
DEL.	Control Arm Lower Rear Bushing Locking nut on mount peg. PS increased DS decreased/increase	<b>MPU-2001K</b>	1	Washers, Outer Shells, Inner Tubes, Bushings	
DEL.	Control Arm Lower-Front Bushing	<b>MPU-1126K</b>	1	Inner Tubes, Bushings	





## MITSUBISHI Magna TE - TF & KE - KF Verada - 4/1996 - 5/1998

Página 2 (Continúa)

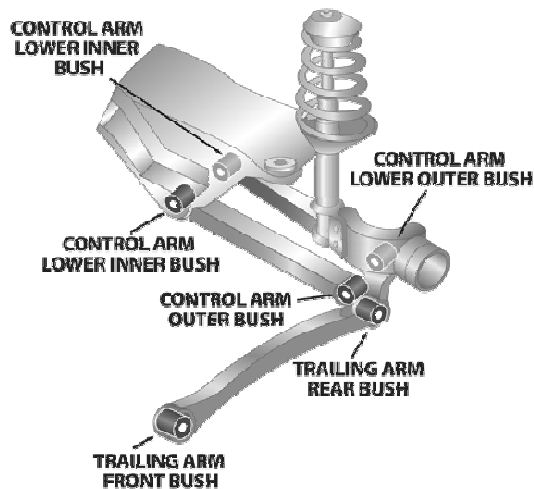
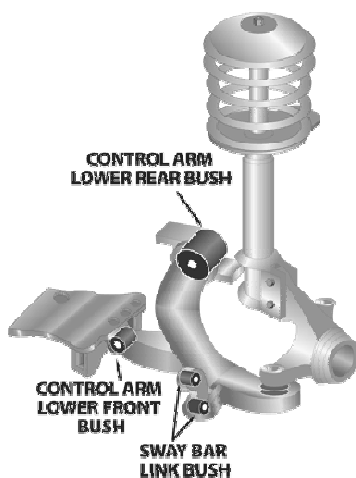







Aplicaci...	Descripción	Referencia	Kits por...	Contenido del Kit	
DEL.	Steering Rack & Pinion Mount Bush.....Power Steering Complete kit both sides	<b>MPU-2304K</b>	1	Inner Tubes, Bushings	
DEL.	Sway Bar Mount To Chassis Bushing Measure bar diameter	<b>MPU-1801-__K</b>	1	Bushings	
TRAS.	Control Arm Lower-Outer Bushing Replaces rubber encased hyme joint style bush	<b>MPU-1953K</b>	1	Inner Tubes, Bushings	
TRAS.	Control Arm Lower-Inner Bushing	<b>MPU-2116K</b>	1	Inner Tubes, Bushings	
TRAS.	Control Arm Upper-Inner Kit	<b>MPU-2115K</b>	1	Inner Tubes, Bushings	
TRAS.	Control Arm Upper-Outer Bushing Bush located in outer hub assembly	<b>MPU-2114K</b>	1	Outer Shells, Bushings	
TRAS.	Trailing Arm Lower Front Bushing Sedan	<b>MPU-2117K</b>	1	Inner Tubes, Bushings	

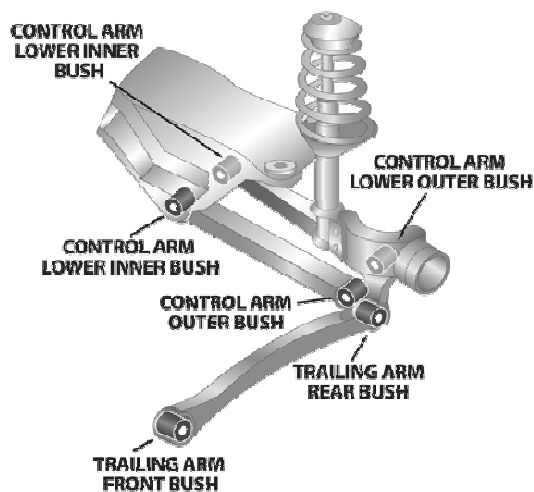
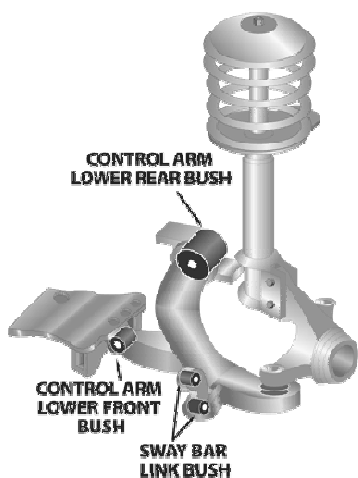

## MITSUBISHI Magna TE - TF & KE - KF Verada - 4/1996 - 5/1998

Página 3 (Continúa)









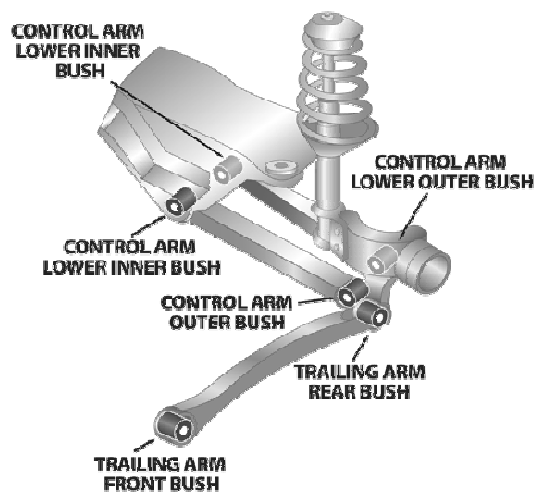
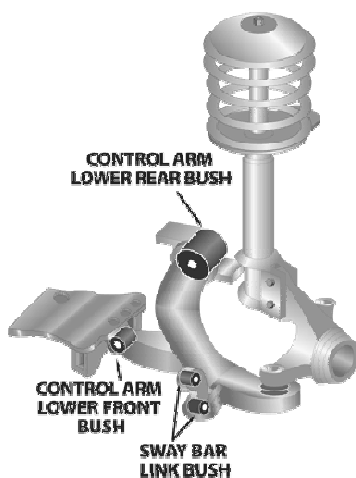

Aplicaci...	Descripción	Referencia	Kits por...	Contenido del Kit	
TRAS.	Trailing Arm Lower Front Bushing Wagon	<b>MPU-0423K</b>	1	Inner Tubes, Bushings	
TRAS.	Trailing Arm Lower Rear Bushing Sedan only, bushing located in outer hub assembly	<b>MPU-2118K</b>	1	Inner Tubes, Bushings	
TRAS.	Trailing Arm Lower Rear Bushing Wagon	<b>MPU-0168K</b>	1	Inner Tubes, Bushings	 0168K
TRAS.	Trailing Arm Upper Bushing All Wagon	<b>MPU-0593K</b>	2	Inner Tubes, Bushings	 0593K



## MITSUBISHI Magna TH - TJ & KH - KJ Verada - 3/1999 - 2003

Página 1



Aplicaci...	Descripción	Referencia	Kits por...	Contenido del Kit	
DEL.	Sway Bar Mount To Chassis Bushing Measure bar diameter	MPU-1801-__K	1	Bushings	
DEL.	Control Arm Lower-Front Bushing	MPU-1126K	1	Inner Tubes, Bushings	 SPF1126K
DEL.	Control Arm Lower-Inner Rear Eccentric \"Slide on mount peg\" PS increased DS standard	MPU-1367K	1	Outer Shells, Bushings	 1 3 6 7 K
DEL.	Control Arm Lower-Inner Rear Eccentric \"Slide on mount peg\" PS increased DS decreased	MPU-1368K	1	Outer Shells, Bushings	 1 3 6 8 K
DEL.	Control Arm Lower-Inner Rear Eccentric \"Locking nut on mount peg\" PS increased DS standard	MPU-2000K	1	Washers, Outer Shells, Inner Tubes, Bushings	
DEL.	Control Arm Lower-Inner Rear Eccentric Locking nut on mount peg. PS increased DS decreased/increase	MPU-2001K	1	Washers, Outer Shells, Inner Tubes, Bushings	
DEL.	Control Arm Lower-Inner Rear Kit \"Slide on mount peg\" PS & DS standard setting	MPU-1366K	1	Outer Shells, Bushings	 1 3 6 6 K



## MITSUBISHI Magna TH - TJ & KH - KJ Verada - 3/1999 - 2003

Página 2 (Continúa)

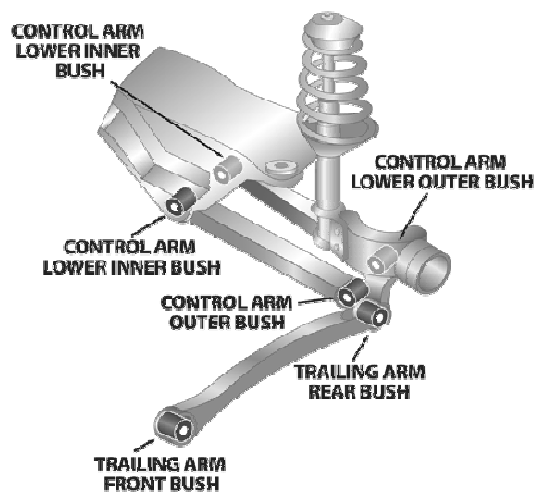
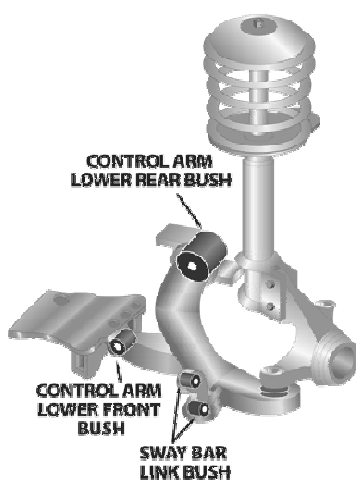







Aplicaci...	Descripción	Referencia	Kits por...	Contenido del Kit	
DEL.	Control Arm Lower-Inner Rear Kit \ "Locking nut on mount peg\ "PS & DS Standard setting	<b>MPU-1999K</b>	1	Washers, Outer Shells, Inner Tubes, Bushings	
DEL.	Steering Rack & Pinion Mount Bush.....Power Steering Complete kit both sides	<b>MPU-2304K</b>	1	Inner Tubes, Bushings	
TRAS.	Control Arm Lower-Inner Bushing	<b>MPU-2116K</b>	1	Inner Tubes, Bushings	
TRAS.	Control Arm Lower-Outer Bushing Replaces rubber encased hyme joint style bush	<b>MPU-1953K</b>	1	Inner Tubes, Bushings	
TRAS.	Control Arm Upper-Inner Kit	<b>MPU-2115K</b>	1	Inner Tubes, Bushings	
TRAS.	Control Arm Upper-Outer Bushing Bush located in outer hub assembly	<b>MPU-2114K</b>	1	Outer Shells, Bushings	
TRAS.	Trailing Arm Lower Front Bushing Sedan	<b>MPU-2117K</b>	1	Inner Tubes, Bushings	

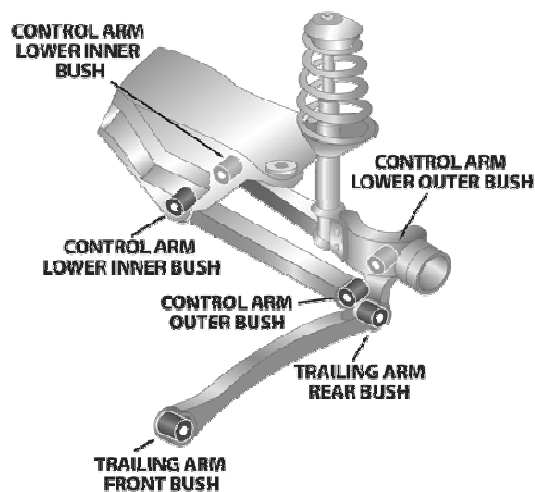
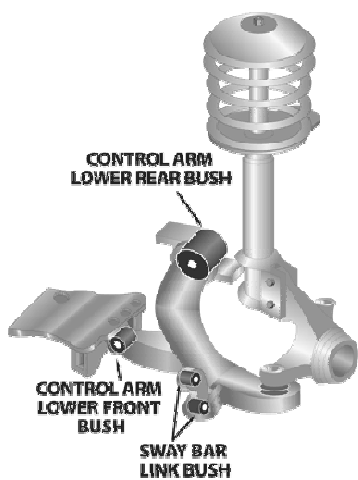

## MITSUBISHI Magna TH - TJ & KH - KJ Verada - 3/1999 - 2003

Página 3 (Continúa)









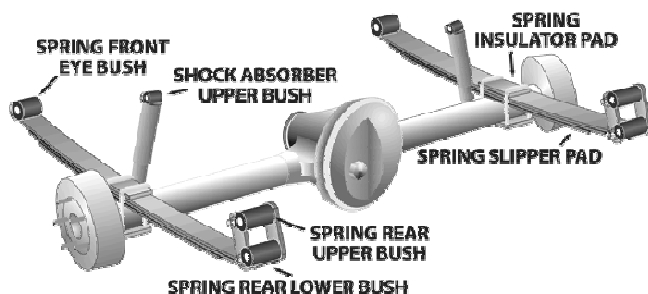
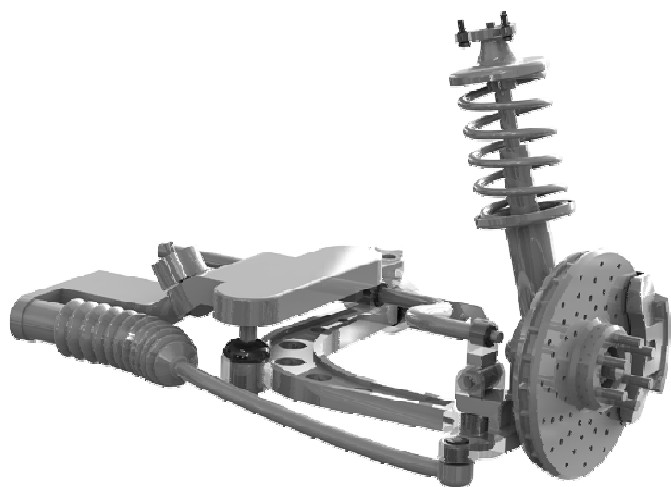

Aplicaci...	Descripción	Referencia	Kits por...	Contenido del Kit	
TRAS.	Trailing Arm Lower Front Bushing Wagon	<b>MPU-0423K</b>	1	Inner Tubes, Bushings	
TRAS.	Trailing Arm Lower Rear Bushing Sedan only, bushing located in outer hub assembly	<b>MPU-2118K</b>	1	Inner Tubes, Bushings	
TRAS.	Trailing Arm Lower Rear Bushing Wagon	<b>MPU-0168K</b>	1	Inner Tubes, Bushings	 0168K
TRAS.	Trailing Arm Upper Bushing All Wagon	<b>MPU-0593K</b>	2	Inner Tubes, Bushings	 0593K



## NISSAN 1200 Sedan, Utility - 5/1970 - 4/1985

Página 1

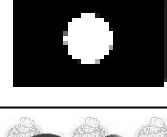

Aplicaci...	Descripción	Referencia	Kits por...	Contenido del Kit	
DEL.	Bump Stop - Upper	<b>MPU-0144K</b>	1	Bushings	 0144K
DEL.	Control Arm Lower-Inner Bushing	<b>MPU-1008K</b>	1	Bushings, Inner Tubes	 1 0 0 8 K
DEL.	Idler Arm Bushing Tapered style bush	<b>MPU-0602K</b>	1	Bushings	 0 6 0 2 K
DEL.	Strut Bar To Chassis Mount Kit	<b>MPU-0054K</b>	1	Bushings	 0054K
DEL.	Sway Bar Link Bushing Kit	<b>MPU-0903K</b>	1	Bushings	 SPF0903K
DEL.	Sway Bar Mount To Chassis Bushing Measure bar diameter 17.5mm, 20mm available	<b>MPU-1078-__K</b>	1	Bushings	
TRAS.	Shock Absorber Upper / Lower Bushing Ute & station wagon	<b>MPU-2178-16K</b>	2	Bushings	 SPF2178- K



**NISSAN 1200 Sedan, Utility - 5/1970 - 4/1985**

Página 2 (Continúa)

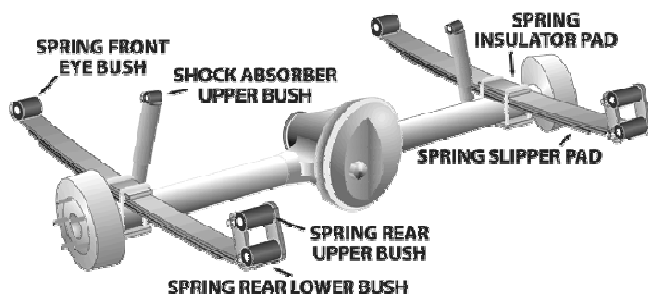
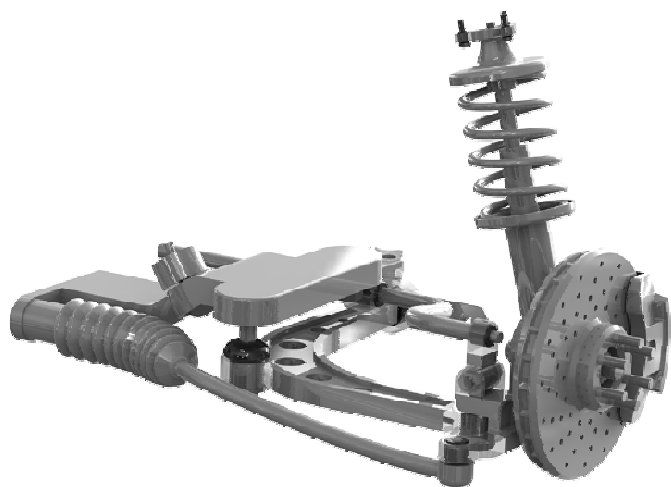

Aplicaci...	Descripción	Referencia	Kits por...	Contenido del Kit	
TRAS.	Spring Front Eye Bushing 13mm Bore	<b>MPU-0025K</b>	1	Bushings	 0025K
TRAS.	Spring Front Eye Bushing 11mm Bore	<b>MPU-1043K</b>	1	Bushings	 1043K
TRAS.	Spring Rear Eye Bushing	<b>MPU-0023K</b>	1	Bushings	 0023K
TRAS.	Spring Shackle Upper Bushing	<b>MPU-0024K</b>	1	Bushings	 0024K



## NISSAN 120Y Sedan -

Página 1

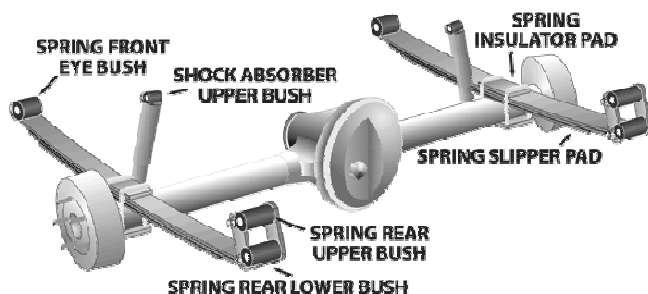
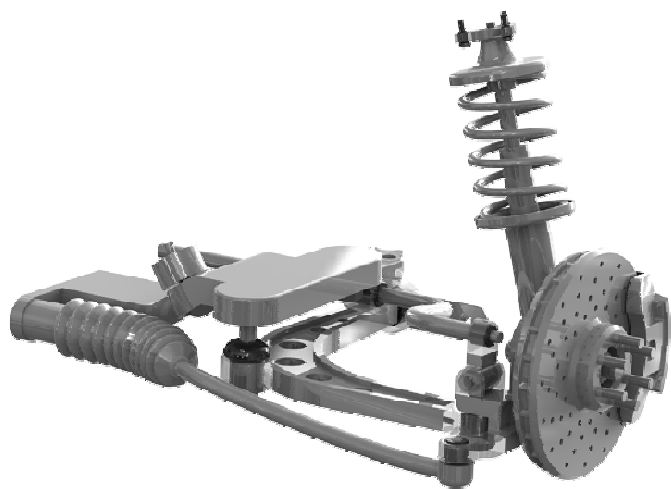

Aplicaci...	Descripción	Referencia	Kits por...	Contenido del Kit	
DEL.	Bump Stop - Upper	<b>MPU-0144K</b>	1	Bushings	
DEL.	Control Arm Lower-Inner Bushing	<b>MPU-1008K</b>	1	Bushings, Inner Tubes	
DEL.	Idler Arm Bushing Tapered style bush	<b>MPU-0602K</b>	1	Bushings	
DEL.	Strut Bar To Chassis Mount Kit	<b>MPU-0054K</b>	1	Bushings	
DEL.	Sway Bar Link Bushing Kit	<b>MPU-2092BK</b>	1	Bushings	
DEL.	Sway Bar Mount To Chassis Bushing Measure bar diameter 17.5mm, 20mm available	<b>MPU-1078-__K</b>	1	Bushings	
TRAS.	Shock Absorber Upper / Lower Bushing Measure pin mount for correct size	<b>MPU-2178-12K</b>	2	Bushings	







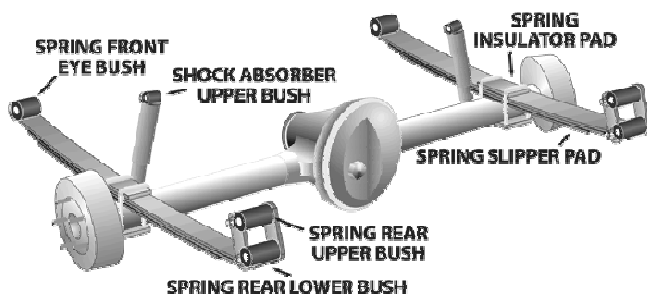
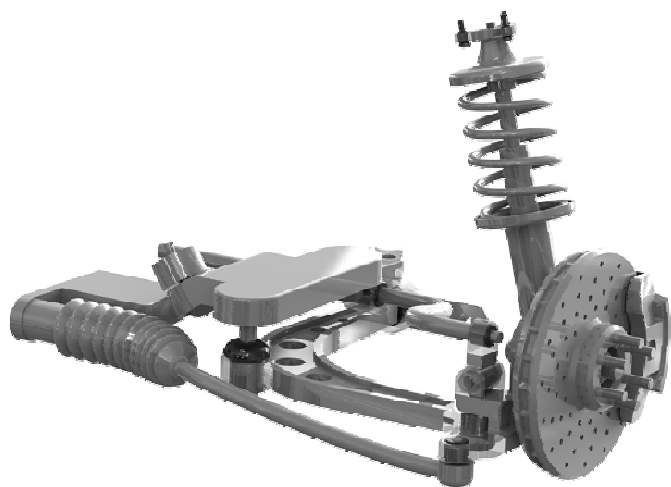

**NISSAN 120Y Sedan -**

Página 2 (Continúa)









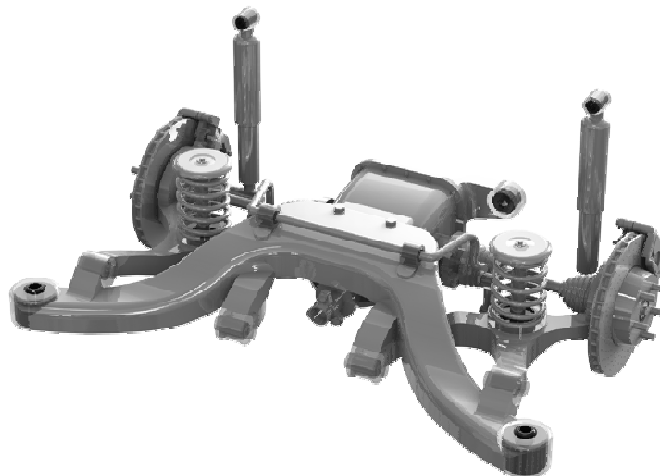
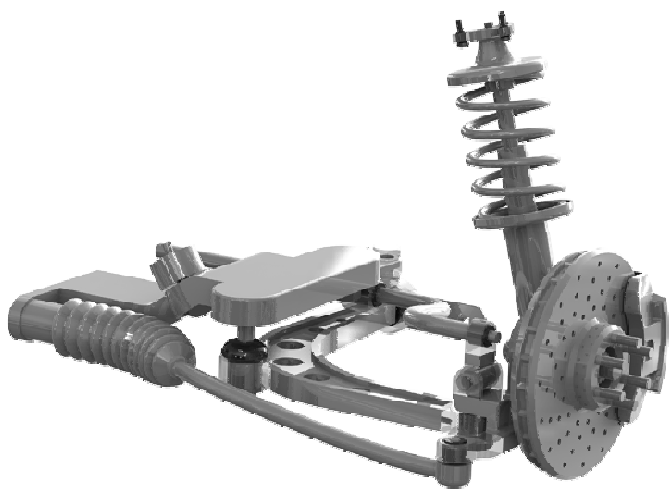

Aplicaci...	Descripción	Referencia	Kits por...	Contenido del Kit	
TRAS.	Shock Absorber Upper / Lower Bushing	<b>MPU-2178-16K</b>	2	Bushings	 SPF2178- K
TRAS.	Spring Front Eye Bushing	<b>MPU-0025K</b>	1	Bushings	 0025K
TRAS.	Spring Rear Eye Bushing	<b>MPU-0023K</b>	1	Bushings	 0023K
TRAS.	Spring Shackle Upper Bushing	<b>MPU-0024K</b>	1	Bushings	 0024K



## NISSAN 1600 4 Door - 1965 - 1972

Página 1



Aplicaci...	Descripción	Referencia	Kits por...	Contenido del Kit	
DEL.	Bump Stop Strut	<b>MPU-0104K</b>	1	Bushings	
DEL.	Control Arm Lower-Inner Bushing Fits 1969 - 1972, Not early model tapered bush	<b>MPU-0564K</b>	1	Inner Tubes, Bushings	
DEL.	Control Arm Lower-Inner Bushing Early tapered style bush	<b>MPU-2641K</b>	1	Bushings, Inner Tubes	
DEL.	Idler Arm Bushing Parallel bore	<b>MPU-0563K</b>	1	Bushings, Inner Tubes	
DEL.	Idler Arm Bushing Tapered bore on housing	<b>MPU-2005K</b>	1	Bushings	
DEL.	Strut Bar To Chassis Mount Kit	<b>MPU-0927K</b>	1	Bushings	
DEL.	Sway Bar Link Bushing Kit	<b>MPU-2092BK</b>	1	Bushings	



## NISSAN 1600 4 Door - 1965 - 1972

Página 2 (Continúa)

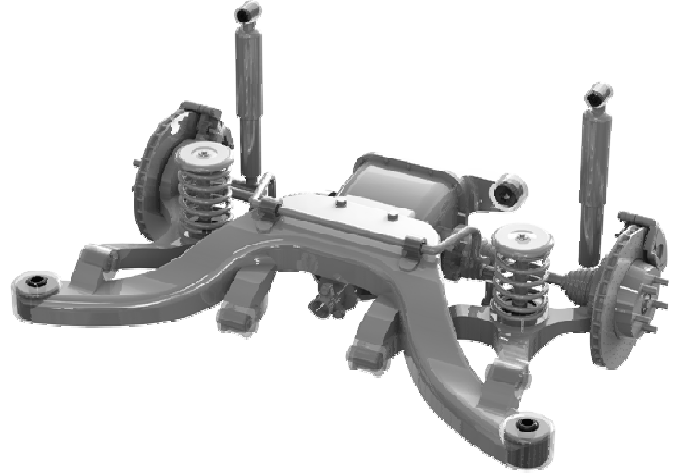
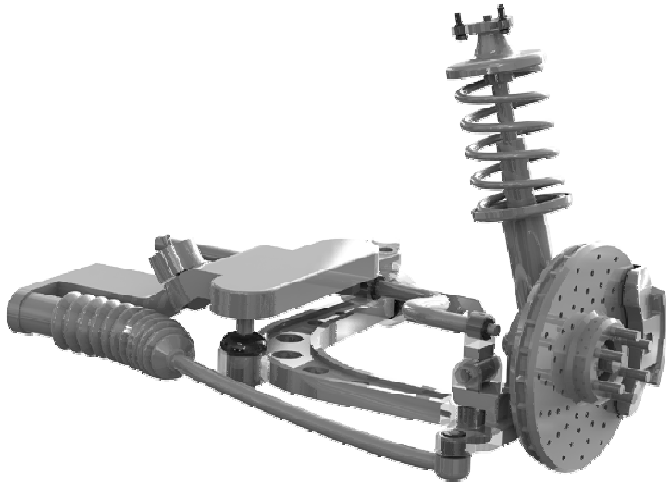







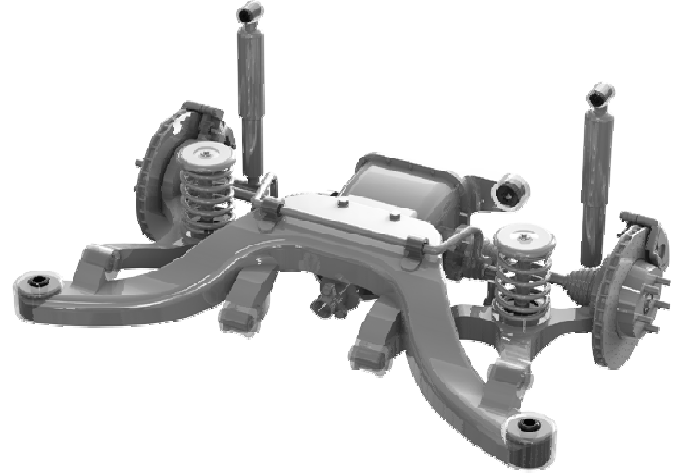
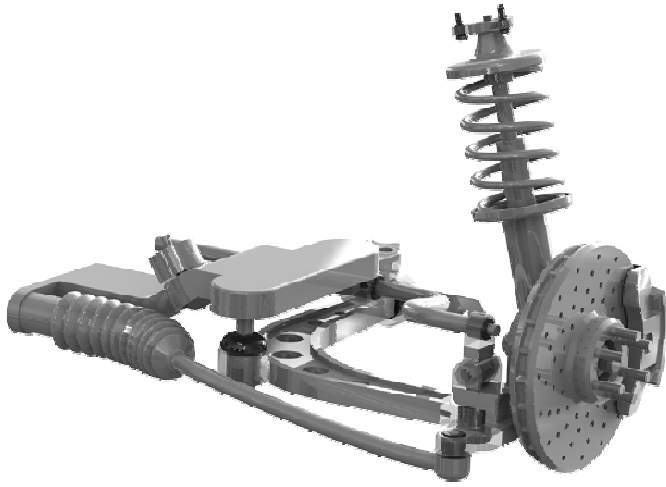

Aplicaci...	Descripción	Referencia	Kits por...	Contenido del Kit	
DEL.	Sway Bar Mount To Chassis Bushing Measure bar diameter 18,20,21,22mm available	<b>MPU-0569-__K</b>	1	Bushings	
TRAS.	Control Arm-Inner Bushing	<b>MPU-0561K</b>	1	Inner Tubes, Bushings	
TRAS.	Cross-member To Chassis Mount	<b>MPU-0270K</b>	1	Inner Tubes, Bushings	
TRAS.	Differential Mount Bushing Moustache bar, 50mm OD Bush	<b>MPU-0246K</b>	1	Inner Tubes, Bushings	
TRAS.	Differential Mount Bushing Moustache bar, 40mm OD Bush	<b>MPU-2033K</b>	1	Bushings, Inner Tubes	
TRAS.	Shock Absorber Lower Bushing	<b>MPU-2178-16K</b>	1	Bushings	
TRAS.	Shock Absorber Upper Bushing	<b>MPU-2755LK</b>	1	Bushings	



NISSAN 180B 610 - 1972 - 1977

Página 1









Aplicaci...	Descripción	Referencia	Kits por...	Contenido del Kit	
DEL.	Bump Stop Strut	<b>MPU-0104K</b>	1	Bushings	 0104K
DEL.	Control Arm Lower-Inner Bushing	<b>MPU-0564K</b>	1	Inner Tubes, Bushings	 5 6 4 K
DEL.	Idler Arm Bushing Parallel bore	<b>MPU-0563K</b>	1	Bushings, Inner Tubes	 5 6 3 K
DEL.	Idler Arm Bushing Tapered bore on housing	<b>MPU-2005K</b>	1	Bushings	
DEL.	Strut Bar To Chassis Mount Kit	<b>MPU-0927K</b>	1	Bushings	 0 9 2 7 K
DEL.	Sway Bar Link Bushing Kit	<b>MPU-2092BK</b>	1	Bushings	 SPF2092BK
DEL.	Sway Bar Mount To Chassis Bushing Measure bar diameter 19,20,22mm available	<b>MPU-1143-__K</b>	1	Bushings	

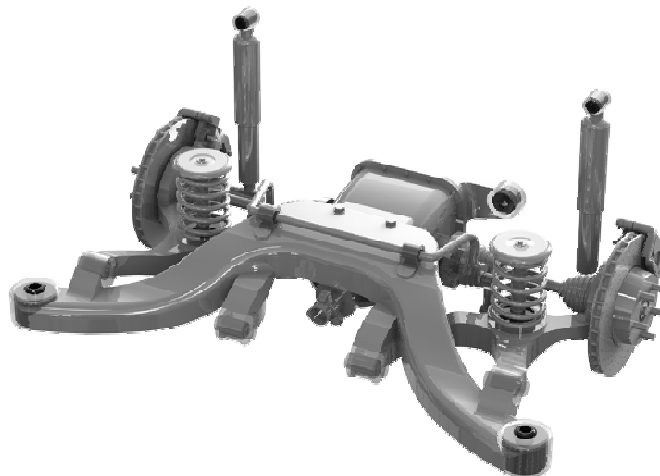
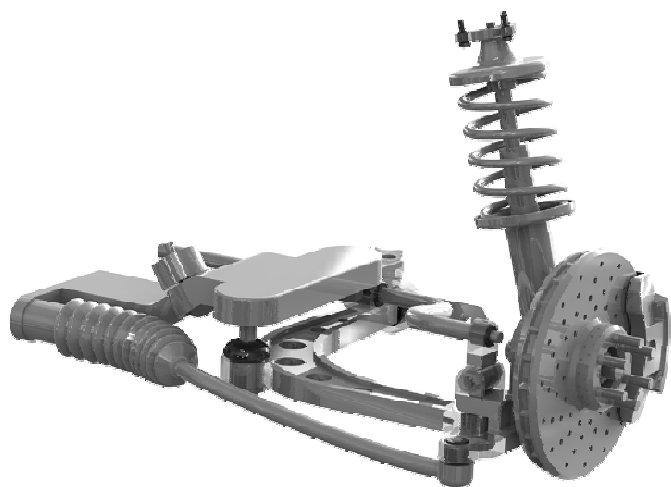

**NISSAN 180B 610 - 1972 - 1977**

Página 2 (Continúa)



Aplicaci...	Descripción	Referencia	Kits por...	Contenido del Kit	
TRAS.	Control Arm-Inner Bushing	<b>MPU-0561K</b>	1	Inner Tubes, Bushings	 5 6 1 K
TRAS.	Cross-member To Chassis Mount	<b>MPU-0270K</b>	1	Inner Tubes, Bushings	 0 2 7 0 K
TRAS.	Differential Mount Bushing Moustache bar, 40mm OD Bush	<b>MPU-2033K</b>	1	Bushings, Inner Tubes	 2 0 3 3 K
TRAS.	Shock Absorber Lower Bushing	<b>MPU-2178-16K</b>	1	Bushings	 SPF2178- K
TRAS.	Shock Absorber Upper Bushing	<b>MPU-2755LK</b>	1	Bushings	 SPF2755LK



## NISSAN Datsun Fairlady / 2000 2 Door Sports Roadsters -...

Página 1

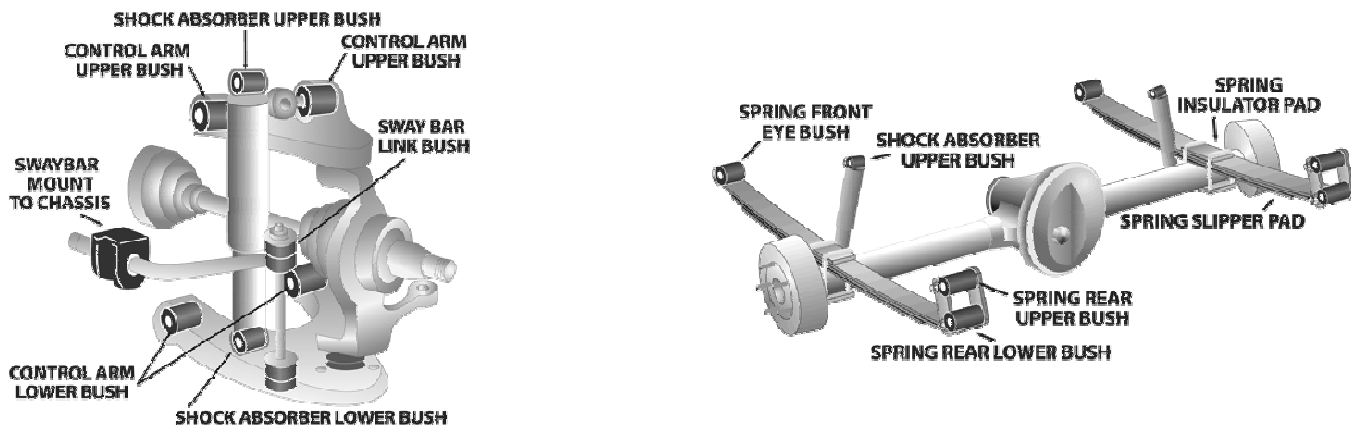







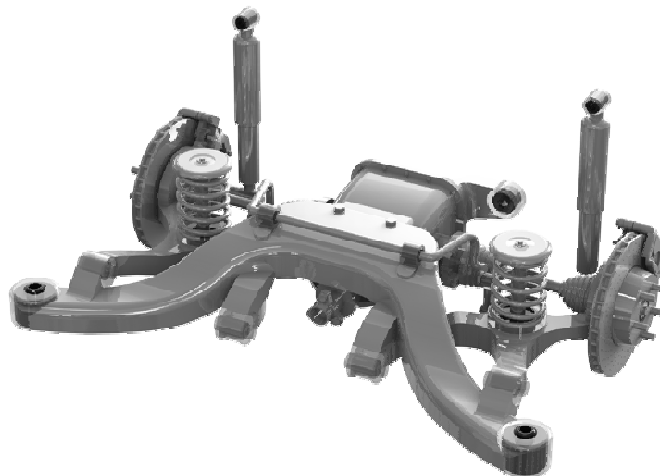
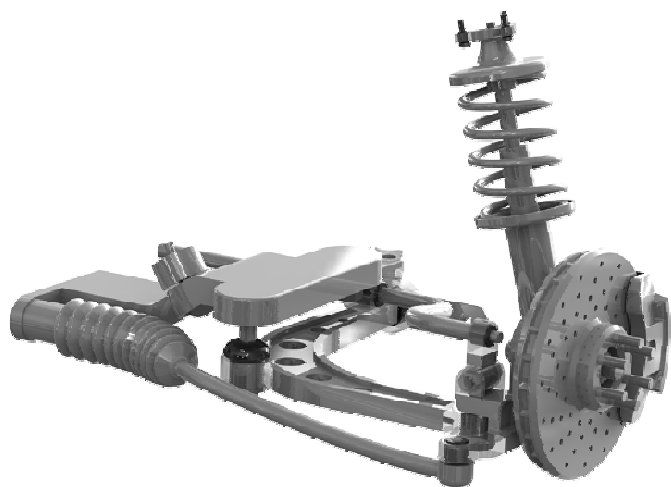

Aplicaci...	Descripción	Referencia	Kits por...	Contenido del Kit	
DEL.	Shock Absorber Upper / Lower Bushing	MPU-2755SK	2	Bushings	
DEL.	Sway Bar Link Bushing Kit	MPU-0247K	1	Bushings	
TRAS.	Shock Absorber Lower Bushing	MPU-2755SK	1	Bushings	
TRAS.	Shock Absorber Upper Bushing	MPU-2178-16K	1	Bushings	
TRAS.	Spring Rear Bushing All	MPU-0431K	1	Bushings	



## NISSAN 200B Sedan - 1977 - 1988

Página 1









Aplicaci...	Descripción	Referencia	Kits por...	Contenido del Kit	
DEL.	Strut Bar To Chassis Mount Kit	<b>MPU-0927K</b>	1	Bushings	
DEL.	Sway Bar Link Bushing Kit	<b>MPU-2092BK</b>	1	Bushings	
DEL.	Sway Bar Mount To Chassis Bushing Measure bar diameter 12mm to 30mm available	<b>MPU-1450-__K</b>	1	Bushings	
DEL.	Control Arm Lower-Inner Bushing	<b>MPU-0562K</b>	1	Bushings, Inner Tubes	
DEL.	Idler Arm Bushing Tapered style bush	<b>MPU-0602K</b>	1	Bushings	
TRAS.	Trailing Arm Lower Bushing All Sedan	<b>MPU-0928K</b>	1	Bushings, Inner Tubes	
TRAS.	Trailing Arm - Bushing Kit IRS ( Independent Rear Suspension )	<b>MPU-0561K</b>	1	Inner Tubes, Bushings	

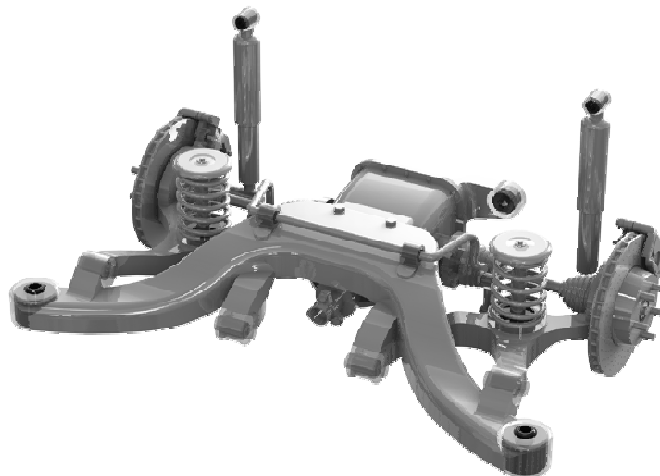
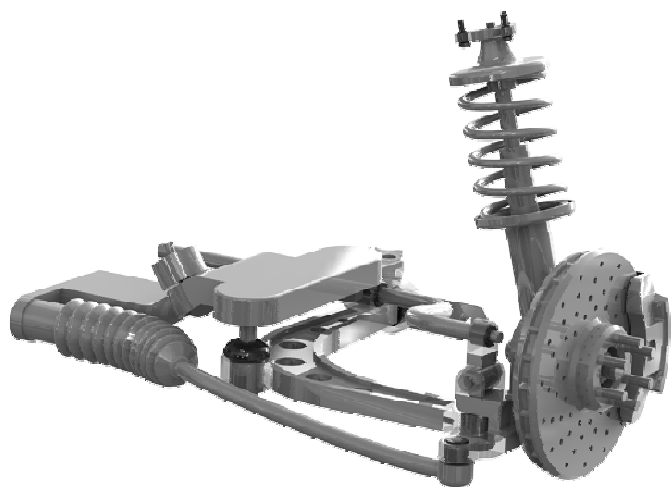

## NISSAN 200B Sedan - 1977 - 1988

Página 2 (Continúa)



Aplicaci...	Descripción	Referencia	Kits por...	Contenido del Kit	
TRAS.	Trailing Arm Upper Bushing All Sedan	<b>MPU-1246K</b>	1	Inner Tubes, Bushings	
TRAS.	Cross-member To Chassis Mount IRS ( Independent Rear Suspension )	<b>MPU-0270K</b>	1	Inner Tubes, Bushings	
TRAS.	Differential Mount Bushing Moustache bar, 50mm OD Bush	<b>MPU-0246K</b>	1	Inner Tubes, Bushings	
TRAS.	Spring Front Eye Bushing Wagon	<b>MPU-0259K</b>	1	Bushings	
TRAS.	Spring Rear Bushing All Wagon	<b>MPU-0260K</b>	1	Bushings	





## NISSAN 240Z (Fairlady) Coupe - 1970 - 1974

Página 1

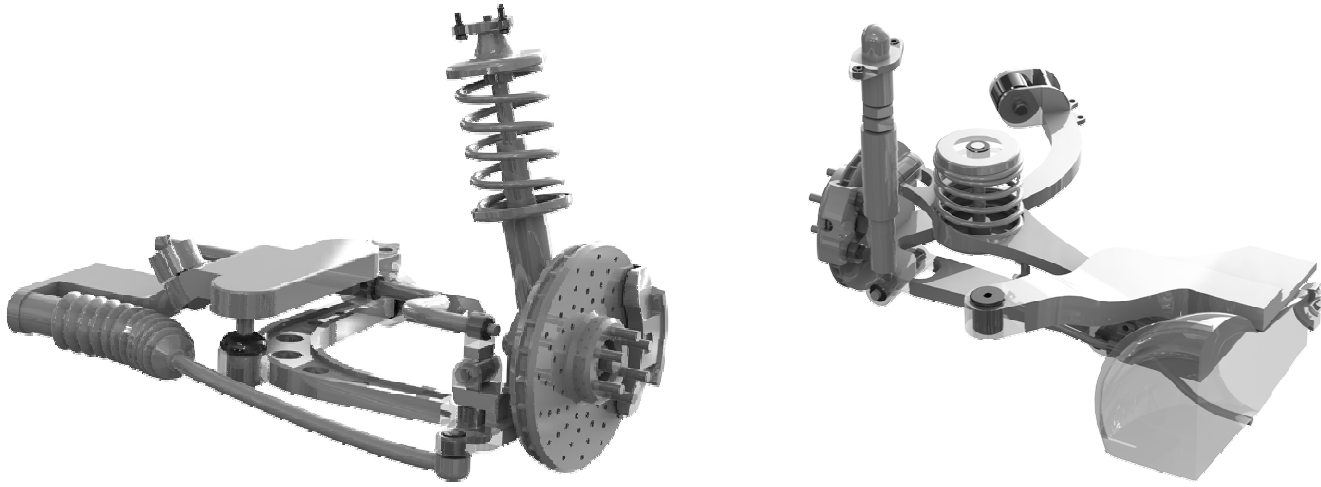







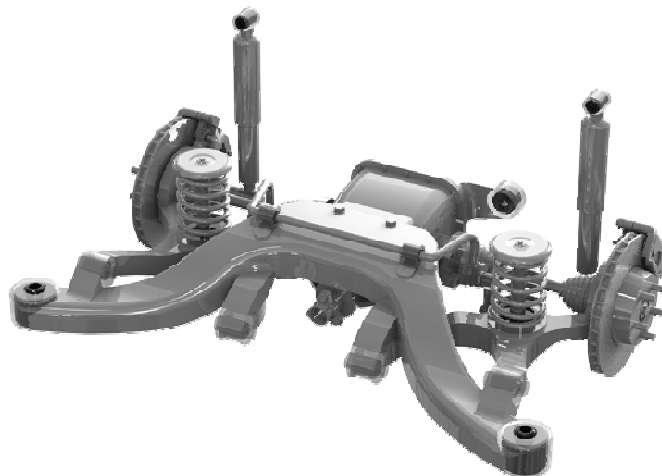
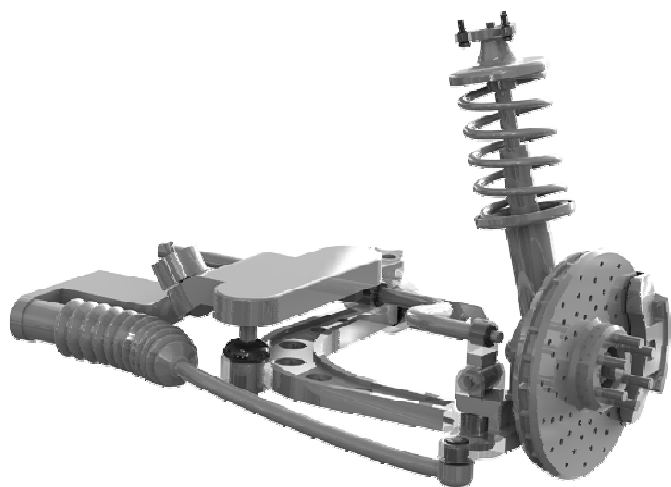

Aplicaci...	Descripción	Referencia	Kits por...	Contenido del Kit	
DEL.	Bump Stop Strut	<b>MPU-0104K</b>	1	Bushings	
DEL.	Control Arm Lower-Inner Bushing	<b>MPU-1215K</b>	1	Bushings, Inner Tubes	
DEL.	Steering Coupling Bushing	<b>MPU-0050K</b>	1	Bushings, Inner Tubes	
DEL.	Steering Rack & Pinion Mount Bush...Manual Steering 240Z	<b>MPU-0033K</b>	1	Bushings	
DEL.	Strut Bar To Chassis Mount Kit	<b>MPU-0927K</b>	1	Bushings	
TRAS.	Bump Stop Strut	<b>MPU-0104K</b>	1	Bushings	
TRAS.	Differential Mount Bushing Moustache bar, 50mm OD Bush	<b>MPU-0246K</b>	1	Inner Tubes, Bushings	



## NISSAN 240K Hardtop - 1973 - 1981

Página 1





Aplicaci...	Descripción	Referencia	Kits por...	Contenido del Kit	
DEL.	Bump Stop Strut	<b>MPU-0104K</b>	1	Bushings	 <b>0104K</b>
DEL.	Control Arm-Inner Bushing	<b>MPU-1224K</b>	1	Bushings	 <b>1 2 2 4 K</b>
DEL.	Idler Arm Bushing	<b>MPU-1003K</b>	1	Bushings	 <b>1 0 0 3 K</b>
DEL.	Strut Bar To Chassis Mount Kit	<b>MPU-0082K</b>	1	Bushings	 <b>0082K</b>
TRAS.	Cross-member To Chassis Mount	<b>MPU-0270K</b>	1	Inner Tubes, Bushings	 <b>0 2 7 0 K</b>
TRAS.	Differential Mount Bushing Moustache bar, 50mm OD Bush	<b>MPU-0246K</b>	1	Inner Tubes, Bushings	 <b>0246K</b>
TRAS.	Shock Absorber Lower Bushing	<b>MPU-0094K</b>	1	Bushings	 <b>0094K</b>

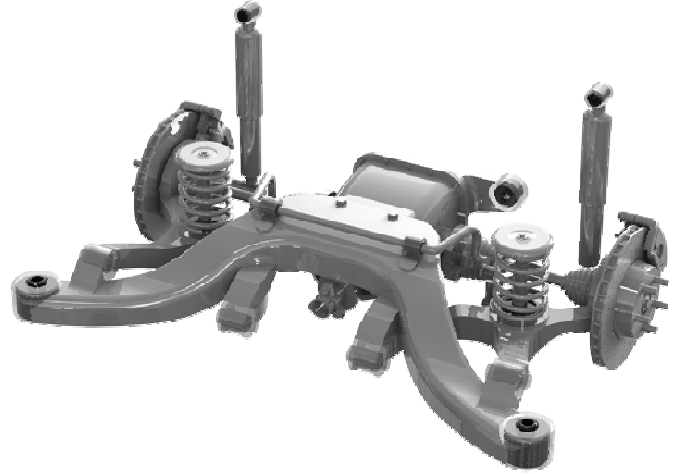
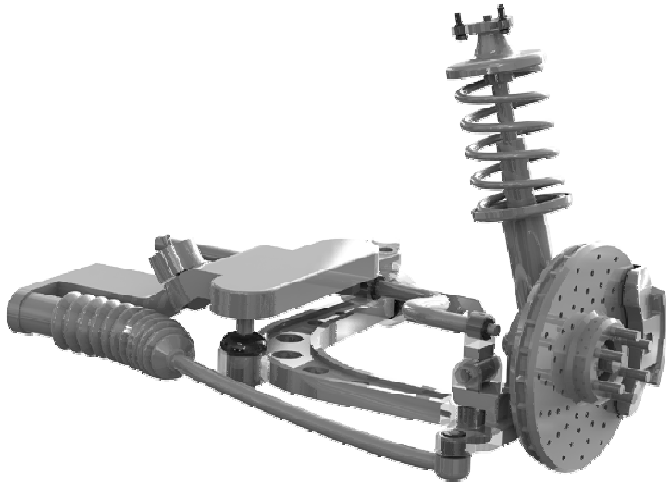

**NISSAN 240K Hardtop - 1973 - 1981**

Página 2 (Continúa)









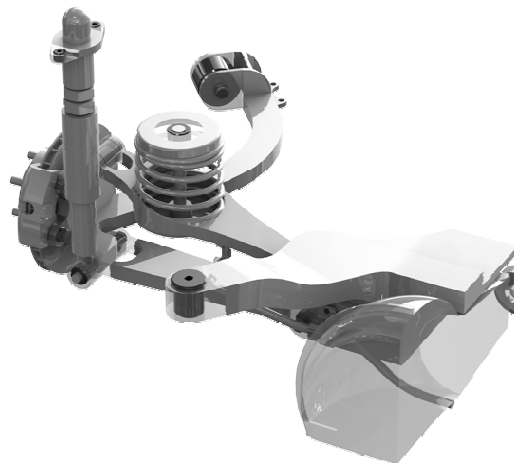
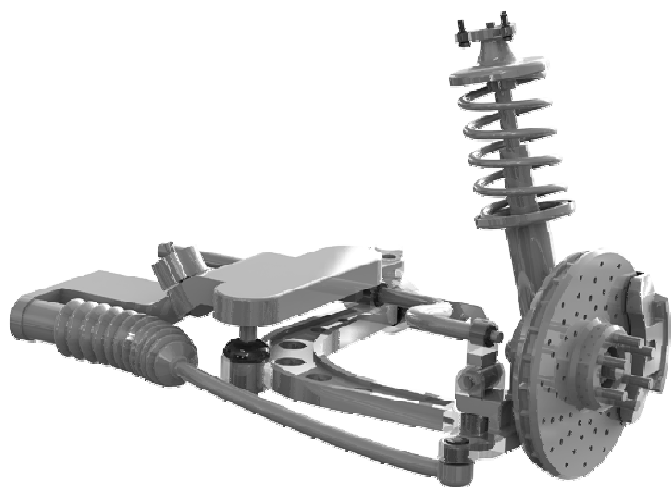

Aplicaci...	Descripción	Referencia	Kits por...	Contenido del Kit	
TRAS.	Shock Absorber Upper Bushing	<b>MPU-2178-16K</b>	1	Bushings	 SPF2178- K



## NISSAN 260Z (Fairlady) Coupe - 1974 - 1978

Página 1







Aplicaci...	Descripción	Referencia	Kits por...	Contenido del Kit	
DEL.	Bump Stop Strut	<b>MPU-0104K</b>	1	Bushings	 0104K
DEL.	Control Arm Lower-Inner Bushing	<b>MPU-1215K</b>	1	Bushings, Inner Tubes	 1 2 1 5 K
DEL.	Steering Coupling Bushing	<b>MPU-0050K</b>	1	Bushings, Inner Tubes	 0050K
DEL.	Steering Rack & Pinion Mount Bush...Manual Steering 260Z	<b>MPU-0034K</b>	1	Bushings	 0 0 3 4 K
DEL.	Strut Bar To Chassis Mount Kit	<b>MPU-0927K</b>	1	Bushings	 0 9 2 7 K
DEL.	Sway Bar Link Bushing Kit	<b>MPU-2092BK</b>	1	Bushings	 SPF2092BK
DEL.	Sway Bar Mount To Chassis Bushing Measure bar diameter 18,20,21,22mm available	<b>MPU-0569-__K</b>	1	Bushings	

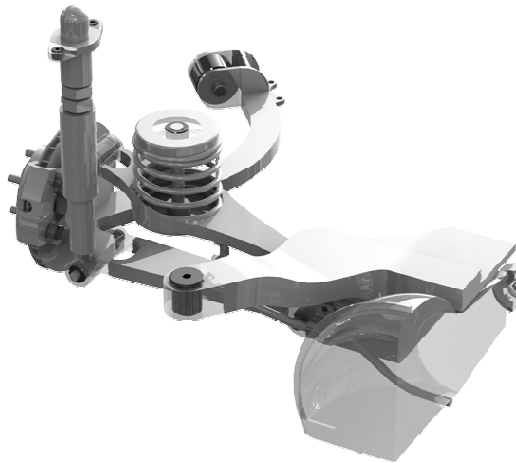
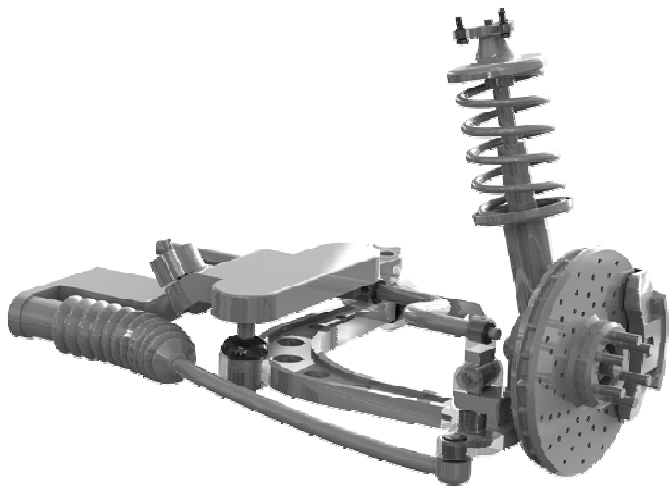

## NISSAN 260Z (Fairlady) Coupe - 1974 - 1978

Página 2 (Continúa)



Aplicaci...	Descripción	Referencia	Kits por...	Contenido del Kit	
TRAS.	Bump Stop Strut	<b>MPU-0104K</b>	1	Bushings	
TRAS.	Differential Mount Bushing Moustache bar, 50mm OD Bush	<b>MPU-0246K</b>	1	Inner Tubes, Bushings	
TRAS.	Sway Bar Mount To Chassis Bushing Measure bar diameter 19,20,22mm available	<b>MPU-1143-__K</b>	1	Bushings	



## NISSAN Bluebird U13 Sedan SSS - 9/1993 - 9/1997

Página 1

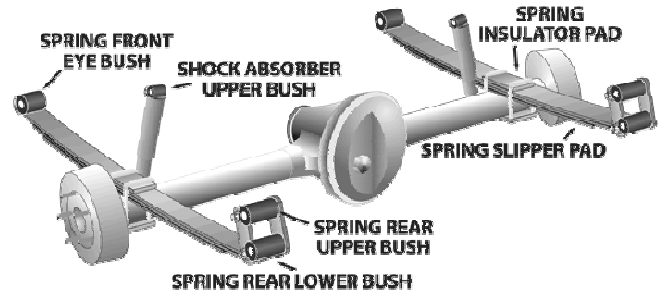
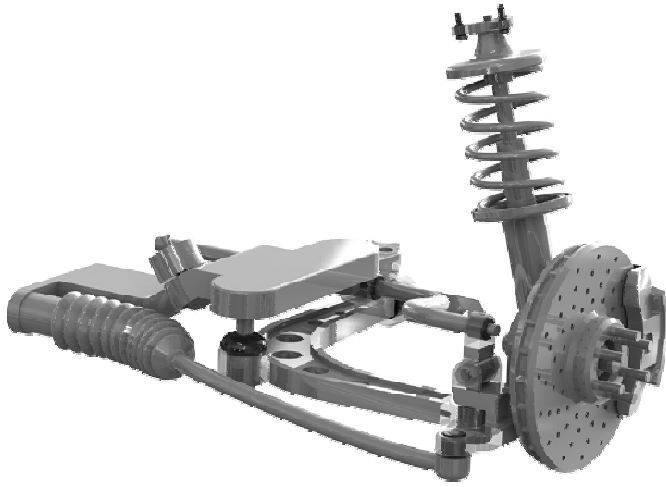







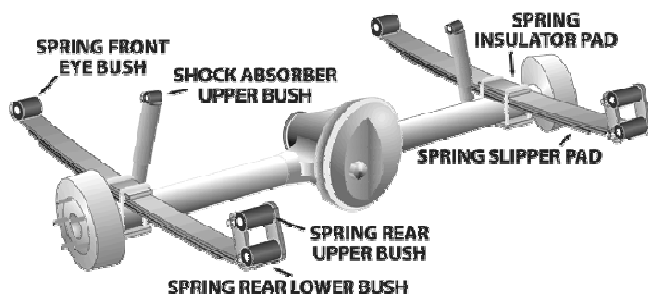
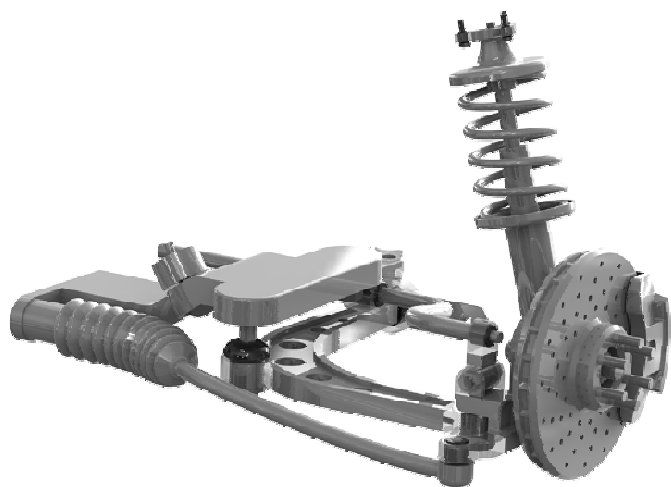

Aplicaci...	Descripción	Referencia	Kits por...	Contenido del Kit	
DEL.	Control Arm Lower Rear Bushing AWD Import vehicle, PS & DS standard setting	<b>MPU-1230K</b>	1	Washers, Bushings	 1 2 3 0 K
DEL.	Control Arm Lower Rear Bushing Front wheel drive vehicle, Standard setting	<b>MPU-1338K</b>	1	Bushings	 1 3 3 8 K
DEL.	Control Arm Lower Rear Bushing Front wheel drive 1 x Offset 1 x Standard bushing, to adjust caster settings	<b>MPU-1339K</b>	1	Bushings	
DEL.	Control Arm Lower Rear Bushing Front wheel drive vehicle, 2 x Offset bushings PS inc DS decrease caster	<b>MPU-1340K</b>	1	Bushings	 1 3 4 0 K
DEL.	Control Arm Lower Rear Bushing AWD Import vehicle, PS increase DS standard caster	<b>MPU-1371K</b>	1	Washers, Bushings	 1 3 7 1 K
DEL.	Control Arm Lower Rear Bushing AWD Import vehicle, PS increase DS increase caster	<b>MPU-1372AK</b>	1	Washers, Bushings	 1 3 7 2 AK
DEL.	Control Arm Lower Rear Bushing AWD Import vehicle, PS increase DS decrease caster	<b>MPU-1372K</b>	1	Washers, Bushings	 1 3 7 2 K



## NISSAN Bluebird U13 Sedan SSS - 9/1993 - 9/1997

Página 2 (Continúa)







Aplicaci...	Descripción	Referencia	Kits por...	Contenido del Kit	
DEL.	Control Arm Lower-Front Bushing Tube = 18mm ID, 47.5mm long Front wheel drive vehicle	<b>MPU-1217K</b>	1	Washers, Inner Tubes, Bushings	
DEL.	Control Arm Lower-Front Bushing Arm with stepped shell, 38mm to 40mm Outside diameter	<b>MPU-1483K</b>	1	Bushings, Inner Tubes, Outer Shells, Washers	
DEL.	Sway Bar Link Bushing Kit	<b>MPU-2092B-4K</b>	1	Bushings	
DEL.	Sway Bar Mount To Chassis Bushing Measure bar diameter 15,21,24,27mm available	<b>MPU-2290-__K</b>	1	Bushings	
TRAS.	Control Arm Lower-Inner Bushing Front wheel drive vehicle, 50mm long crush tube	<b>MPU-1750K</b>	1	Inner Tubes, Bushings	
TRAS.	Control Arm Upper-Inner / Outer Kit Front wheel drive vehicle, 40mm crush tube	<b>MPU-1638K</b>	1	Inner Tubes, Bushings	
TRAS.	Radius Arm Upper-Inner/Outer Bushing Front wheel drive vehicle, 40mm crush tube	<b>MPU-1638K</b>	1	Inner Tubes, Bushings	

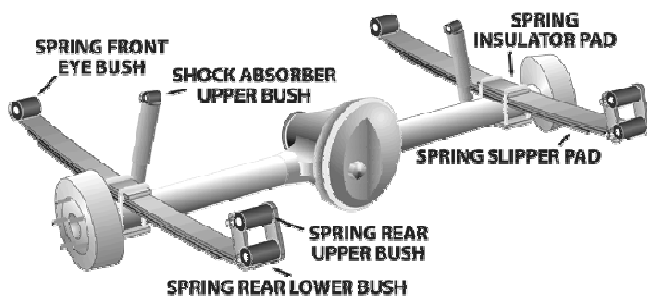
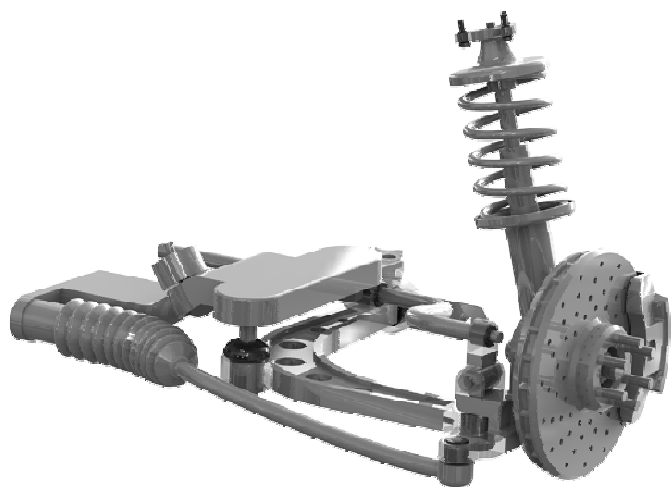

**NISSAN Bluebird U13 Sedan SSS - 9/1993 - 9/1997**

Página 3 (Continúa)



Aplicaci...	Descripción	Referencia	Kits por...	Contenido del Kit	
TRAS.	Sway Bar Link Bushing Kit Front wheel drive vehicle	<b>MPU-2667K</b>	1	Bushings	
TRAS.	Sway Bar Mount To Chassis Bushing Measure bar diameter 15,16,18,20,22,23,24mm available	<b>MPU-1485-__K</b>	1	Bushings	





## NISSAN EXA Coupe - 1987 - 1991

Página 1

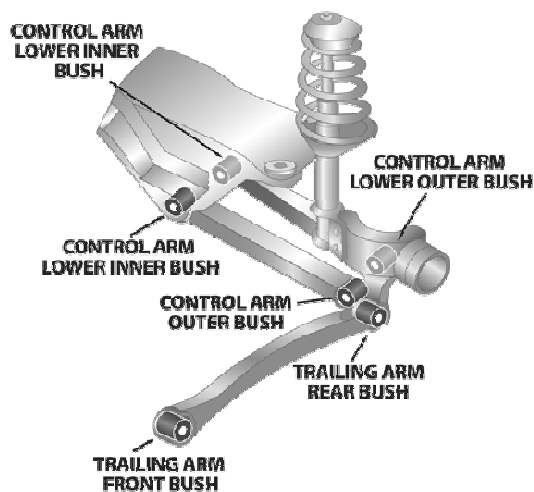
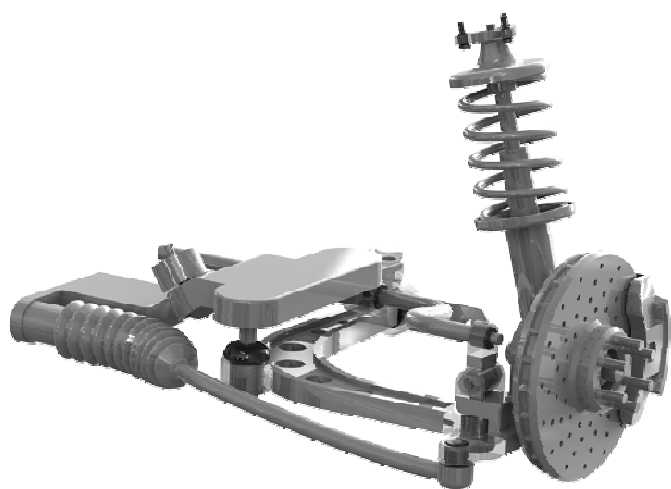







Aplicaci...	Descripción	Referencia	Kits por...	Contenido del Kit	
DEL.	Control Arm Lower Rear Bushing PS & DS standard	<b>MPU-0864K</b>	1	Bushings, Washers	
DEL.	Control Arm Lower Rear Bushing PS Increased DS standard caster	<b>MPU-1373K</b>	1	Washers, Bushings	
DEL.	Control Arm Lower Rear Bushing PS & DS Increased caster	<b>MPU-1374AK</b>	1	Washers, Bushings	
DEL.	Control Arm Lower Rear Bushing PS Increased DS decrease caster	<b>MPU-1374K</b>	1	Washers, Bushings	
DEL.	Control Arm Lower-Front Bushing Must remove original shell	<b>MPU-0506K</b>	1	Bushings, Inner Tubes	
DEL.	Steering Rack & Pinion Mount Bush....Manual Steering	<b>MPU-0739K</b>	1	Bushings	
DEL.	Sway Bar Link Lower Bushing	<b>MPU-0903-4K</b>	1	Bushings	

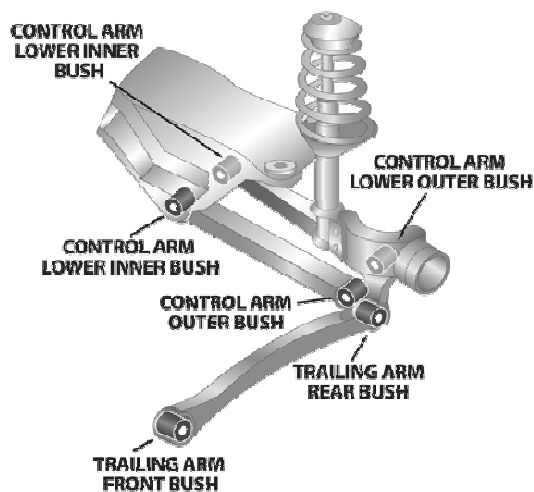
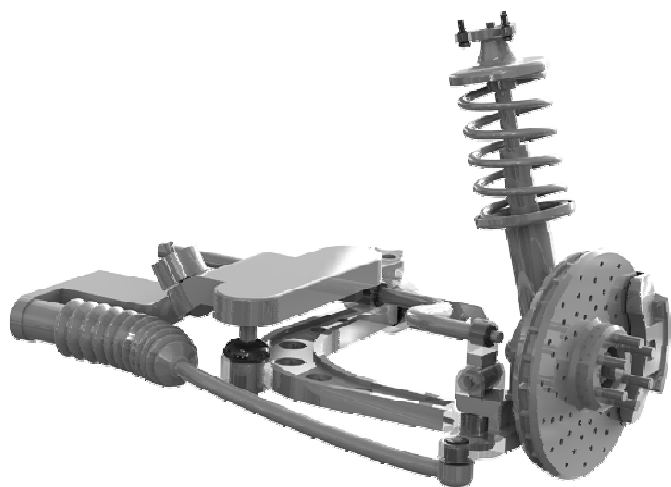

## NISSAN EXA Coupe - 1987 - 1991

Página 2 (Continúa)



Aplicaci...	Descripción	Referencia	Kits por...	Contenido del Kit	
DEL.	Sway Bar Mount To Chassis Bushing Measure bar diameter 22,24,27mm available	<b>MPU-0616-__K</b>	1	Bushings	
TRAS.	Control Arm Lower-Inner & Outer Kit Includes 40mm long crush tubes	<b>MPU-0862K</b>	1	Inner Tubes, Bushings	
TRAS.	Sway Bar Mount To Chassis Bushing Measure bar diameter 24, 26.5mm available	<b>MPU-0865-__K</b>	1	Bushings	
TRAS.	Sway Bar To Hub Mount Bushing	<b>MPU-0861K</b>	1	Bushings	



## NISSAN Gazelle Coupe, Hatchback S12 - 1/1984 - 2/1989

Página 1

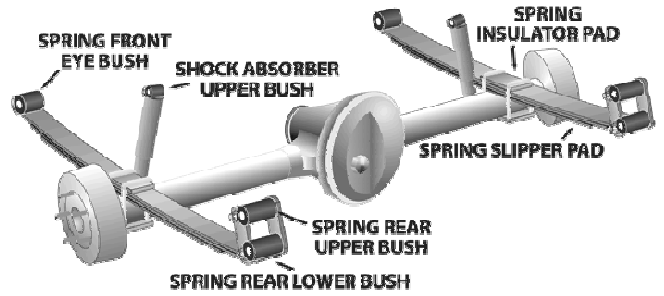
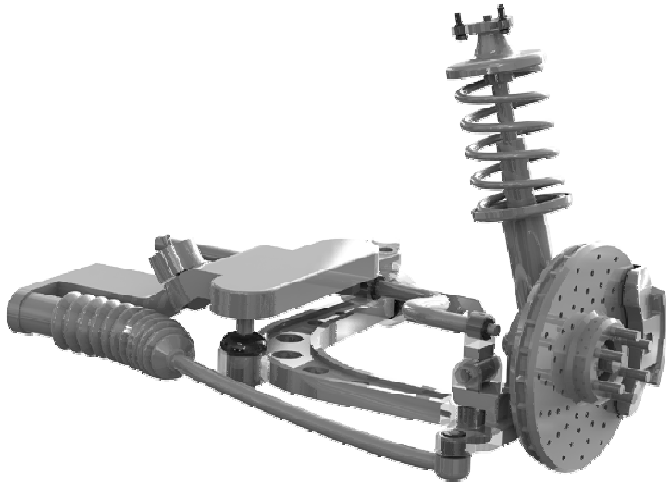

Aplicaci...	Descripción	Referencia	Kits por...	Contenido del Kit	
DEL.	Control Arm Lower-Inner Bushing Stepped shell 34mm to 36mm outside diameter	<b>MPU-1009K</b>	1	Bushings, Inner Tubes, Outer Shells	
DEL.	Strut Bar To Chassis Mount Kit	<b>MPU-0927K</b>	1	Bushings	
DEL.	Sway Bar Link Bushing Kit	<b>MPU-2092BK</b>	1	Bushings	
DEL.	Sway Bar Mount To Chassis Bushing Measure bar diameter 23,25,27mm available	<b>MPU-1106-_K</b>	1	Bushings	
TRAS.	Trailing Arm - Bushing Kit Solid axle rear	<b>MPU-0836K</b>	1	Bushings, Inner Tubes	
TRAS.	Trailing Arm Upper Bushing All	<b>MPU-0835K</b>	1	Inner Tubes, Bushings	



## NISSAN Pintara U12 - 11/1989 - 4/1993

Página 1

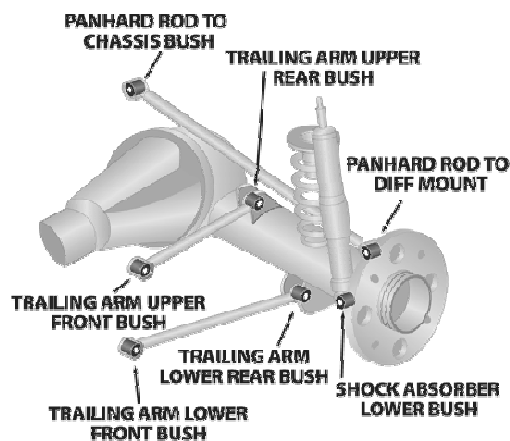
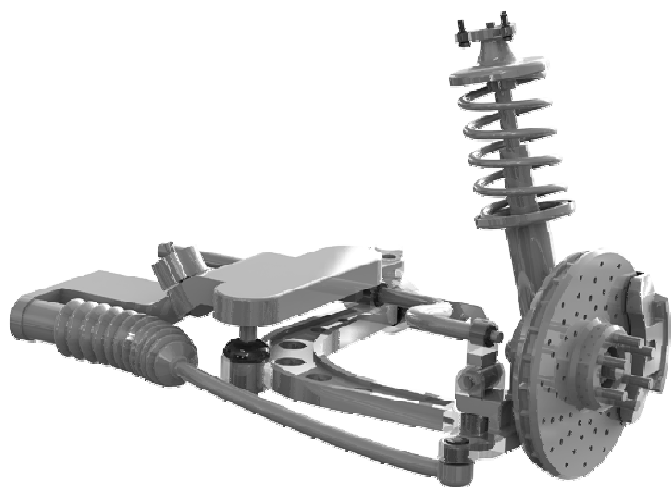

Aplicaci...	Descripción	Referencia	Kits por...	Contenido del Kit	
DEL.	Control Arm Lower Rear Bushing PS & DS standard setting (Large "D" style bush design)	<b>MPU-1230K</b>	1	Washers, Bushings	 1 2 3 0 K
DEL.	Control Arm Lower Rear Bushing PS increase DS standard (Large "D" style bush)	<b>MPU-1371K</b>	1	Washers, Bushings	 1 3 7 1 K
DEL.	Control Arm Lower Rear Bushing PS increase DS increase caster (Large "D" style bush)	<b>MPU-1372AK</b>	1	Washers, Bushings	 1 3 7 2 AK
DEL.	Control Arm Lower Rear Bushing PS increase DS decrease caster (Large "D" style bush)	<b>MPU-1372K</b>	1	Washers, Bushings	 1 3 7 2 K
DEL.	Control Arm Lower-Front Bushing Tube = 16mm ID, 60mm long	<b>MPU-0957K</b>	1	Bushings, Inner Tubes	 0 9 5 7 K
DEL.	Control Arm Lower-Front Bushing Tube = 18mm ID, 47.5mm long	<b>MPU-1217K</b>	1	Washers, Inner Tubes, Bushings	
DEL.	Steering Rack & Pinion Shaft Guide.....Bush Kit TRW Steering rack manual steering	<b>MPU-0926K</b>	1	Bushings	 0 9 2 6 K



## NISSAN Pintara U12 - 11/1989 - 4/1993

Página 2 (Continúa)

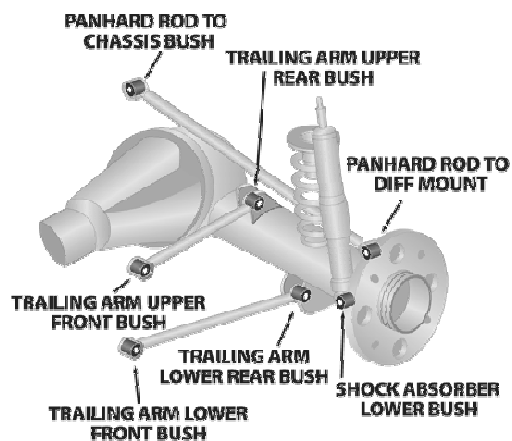
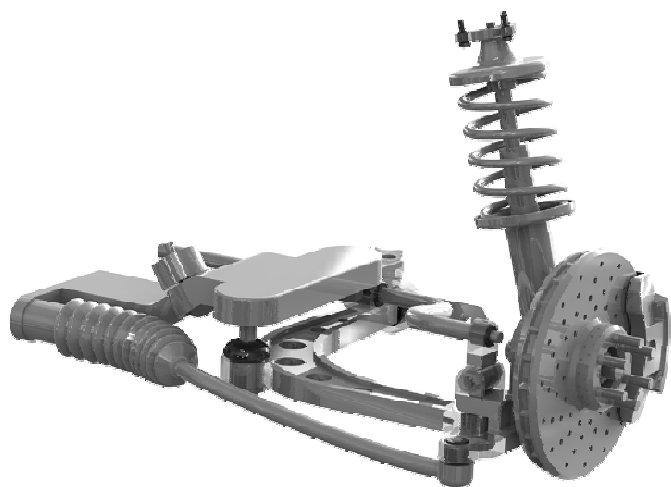







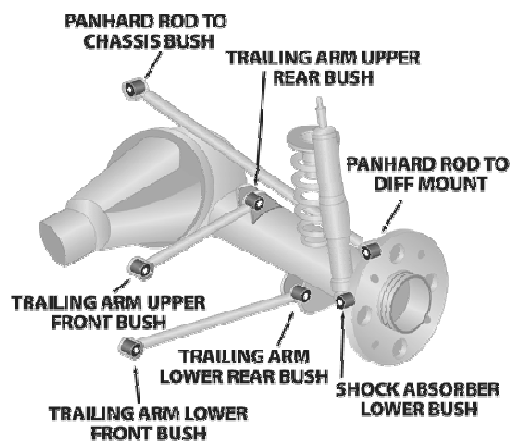
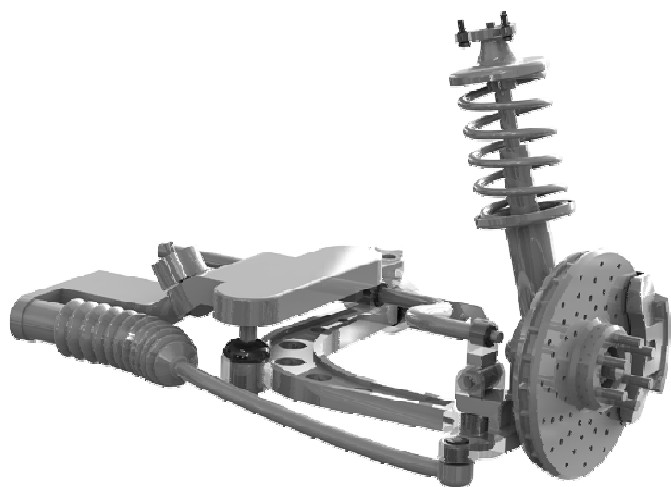

Aplicaci...	Descripción	Referencia	Kits por...	Contenido del Kit	
DEL.	Sway Bar Link Bushing Kit	MPU-2092BK	1	Bushings	
DEL.	Sway Bar Mount To Chassis Bushing Measure bar diameter 16,22,24,25,26,27,28mm available	MPU-1135-__K	1	Bushings	
TRAS.	Control Arm-Bush Kit	MPU-0691K	1	Inner Tubes, Bushings	
TRAS.	Sway Bar Link Bushing Kit	MPU-0903K	1	Bushings	
TRAS.	Sway Bar Mount To Chassis Bushing Measure bar diameter 15,16,18mm available	MPU-1108-__K	1	Bushings	
TRAS.	Trailing Arm - Bushing Kit	MPU-0959K	1	Inner Tubes, Bushings	



## NISSAN Pintara R31 4Cyl - 6/1986 - 10/1990

Página 1



Aplicaci...	Descripción	Referencia	Kits por...	Contenido del Kit	
DEL.	Control Arm Lower-Inner Bushing Stepped shell 34mm to 36mm outside diameter	<b>MPU-1009K</b>	1	Bushings, Inner Tubes, Outer Shells	
DEL.	Steering Coupling Bushing Manual & Power steering	<b>MPU-0624K</b>	1	Inner Tubes	
DEL.	Steering Rack & Pinion Mount Bush.....Power Steering TRW Rack	<b>MPU-2771K</b>	1	Bushings	
DEL.	Steering Rack & Pinion Shaft Guide.....Bush Kit TRW Steering rack manual steering	<b>MPU-0926K</b>	1	Bushings	
DEL.	Strut Bar To Chassis Mount Kit	<b>MPU-0927K</b>	1	Bushings	
DEL.	Sway Bar Link Bushing Kit	<b>MPU-2092BK</b>	1	Bushings	
DEL.	Sway Bar Mount To Chassis Bushing Measure bar diameter 23,25,27mm available	<b>MPU-1106-__K</b>	1	Bushings	



## NISSAN Pintara R31 4Cyl - 6/1986 - 10/1990

Página 2 (Continúa)

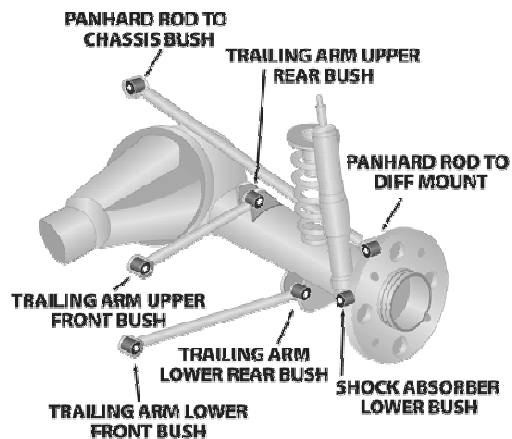
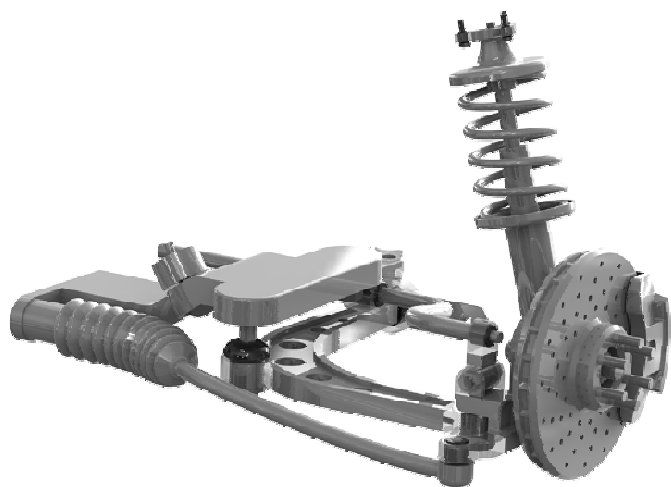







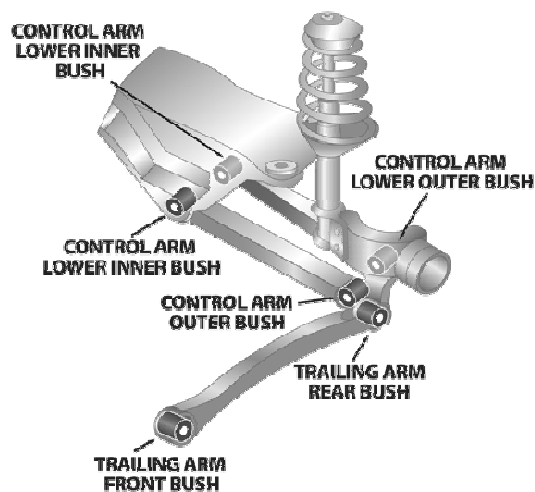
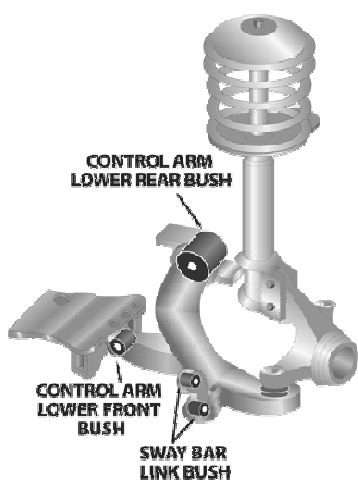

Aplicaci...	Descripción	Referencia	Kits por...	Contenido del Kit	
TRAS.	Panhard Rod To Chassis Mount Kit	<b>MPU-0620K</b>	1	Bushings, Inner Tubes	
TRAS.	Panhard Rod To Diff Mount Bushing	<b>MPU-0621K</b>	1	Inner Tubes, Bushings	
TRAS.	Shock Absorber Lower Bushing Station wagon	<b>MPU-2178-16K</b>	1	Bushings	
TRAS.	Sway Bar Link Bushing Kit	<b>MPU-0903K</b>	1	Bushings	
TRAS.	Sway Bar Mount To Axle Bushing Measure bar diameter 15,16,18mm available	<b>MPU-1108-__K</b>	1	Bushings	
TRAS.	Trailing Arm Lower Bushing All	<b>MPU-0610K</b>	2	Inner Tubes, Bushings	
TRAS.	Trailing Arm Upper Rear Bushing	<b>MPU-0619K</b>	1	Bushings, Inner Tubes	



## NISSAN Pulsar / Sentra / Sunny / Almera N15 LX Sedan &...

Página 1



Aplicaci...	Descripción	Referencia	Kits por...	Contenido del Kit	
DEL.	Control Arm Lower Rear Bushing Standard setting	<b>MPU-1338K</b>	1	Bushings	
DEL.	Control Arm Lower Rear Bushing 1 x Offset 1 x Standard bushing, to adjust caster settings	<b>MPU-1339K</b>	1	Bushings	
DEL.	Control Arm Lower Rear Bushing 2 x Offset bushings, Increase positive caster both sides	<b>MPU-1340AK</b>	1	Bushings	
DEL.	Control Arm Lower Rear Bushing 2 x Offset bushings, PS increased DS decrease caster	<b>MPU-1340K</b>	1	Bushings	
DEL.	Control Arm Lower-Front Bushing	<b>MPU-1341K</b>	1	Washers, Inner Tubes, Bushings	
DEL.	Steering Rack & Pinion Mount Bush.....Power Steering	<b>MPU-1834K</b>	1	Bushings	
DEL.	Sway Bar Link Lower Bushing	<b>MPU-2092B-4K</b>	1	Bushings	





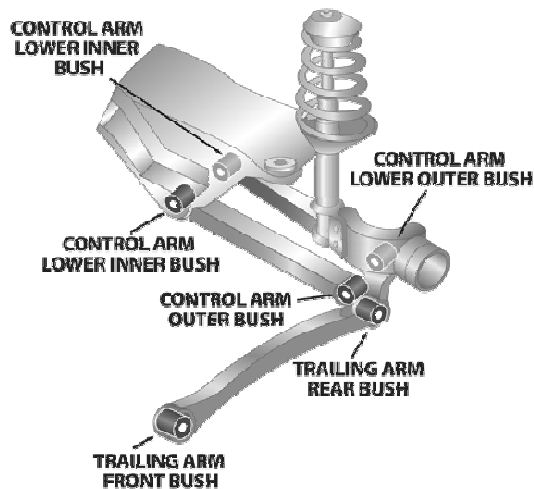
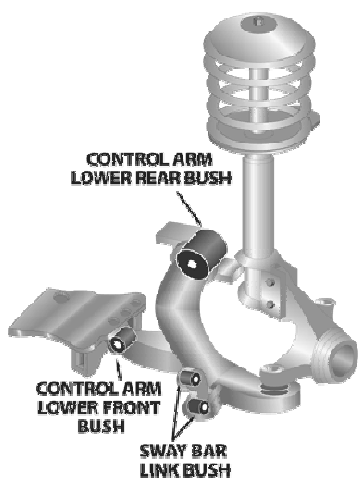

**NISSAN Pulsar / Sentra / Sunny / Almera N15 LX Sedan &...**

Página 2 (Continúa)



Aplicaci...	Descripción	Referencia	Kits por...	Contenido del Kit	
DEL.	Sway Bar Mount To Chassis Bushing Measure bar diameter 16,22,24,25,26,27,28mm available	<b>MPU-1135-__K</b>	1	Bushings	
TRAS.	Beam Axle Pivot Bushing Do not remove original shell as you have to re-use	<b>MPU-1942K</b>	1	Inner Tubes, Bushings	



**NISSAN Pulsar / Sentra / Sunny / Almera N16 Sedan &...**

Página 1

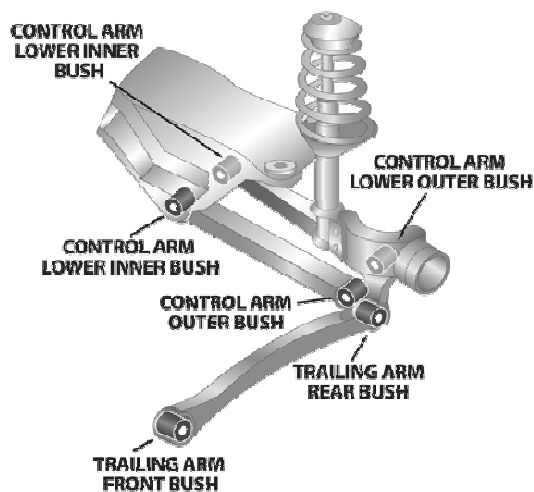
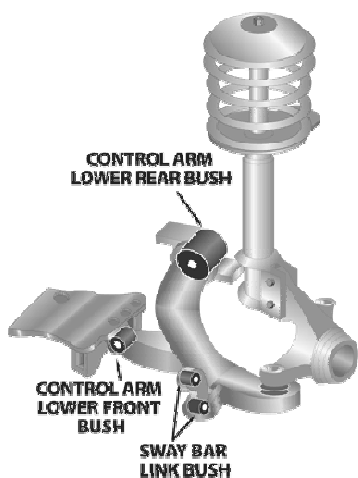

Aplicaci...	Descripción	Referencia	Kits por...	Contenido del Kit	
DEL.	Control Arm Lower Rear Bushing Standard bushings	<b>MPU-2478K</b>	1	Outer Shells, Bushings, Washers	
DEL.	Control Arm Lower Rear Bushing 1 x Offset bushing & 1 x Standard bushing	<b>MPU-2479K</b>	1	Bushings, Outer Shells	
DEL.	Control Arm Lower Rear Bushing 2 x Offset bushings	<b>MPU-2480K</b>	1	Bushings, Outer Shells	
DEL.	Control Arm Lower-Front Bushing	<b>MPU-2477K</b>	1	Bushings, Inner Tubes	
DEL.	Steering Rack & Pinion Mount Bushing Passenger Side Bush.	<b>MPU-3560K</b>	1	Inst Sheet, Bushings	
TRAS.	Beam Axle Pivot Bushing Do not remove original shell as you have to re-use	<b>MPU-1942K</b>	1	Inner Tubes, Bushings	



NISSAN Pulsar / Sentra / Sunny / Almera N13 B12 Sedan &...

Página 1

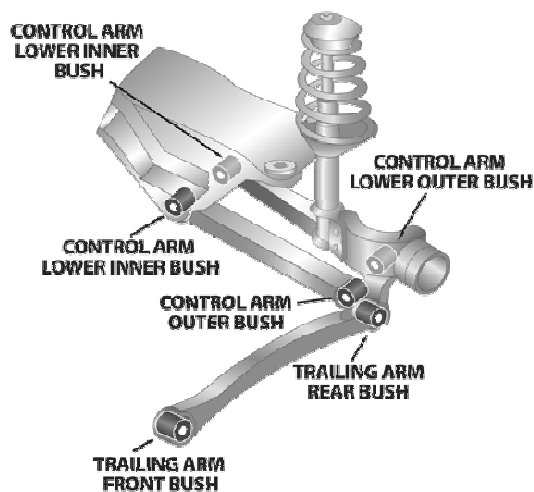
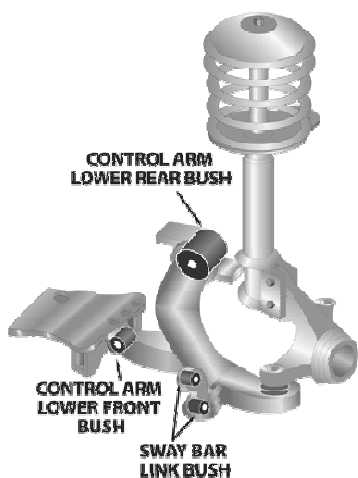



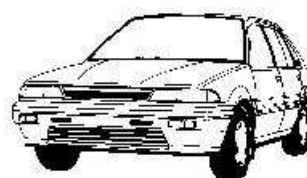



Aplicaci...	Descripción	Referencia	Kits por...	Contenido del Kit	
DEL.	Control Arm Lower Rear Bushing PS & DS standard	<b>MPU-0864K</b>	1	Bushings, Washers	
DEL.	Control Arm Lower Rear Bushing PS increased DS standard caster	<b>MPU-1373K</b>	1	Washers, Bushings	
DEL.	Control Arm Lower Rear Bushing PS & DS increased caster	<b>MPU-1374AK</b>	1	Washers, Bushings	
DEL.	Control Arm Lower Rear Bushing PS increased DS decrease caster	<b>MPU-1374K</b>	1	Washers, Bushings	
DEL.	Control Arm Lower-Front Bushing Must remove original shell	<b>MPU-0506K</b>	1	Bushings, Inner Tubes	
DEL.	Steering Rack & Pinion Shaft Guide.....Bush Kit TRW Steering rack manual steering	<b>MPU-0926K</b>	1	Bushings	
DEL.	Sway Bar Link Lower Bushing	<b>MPU-0903-4K</b>	1	Bushings	

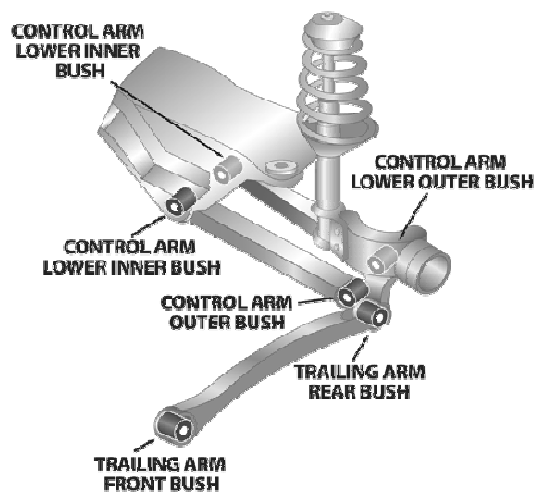
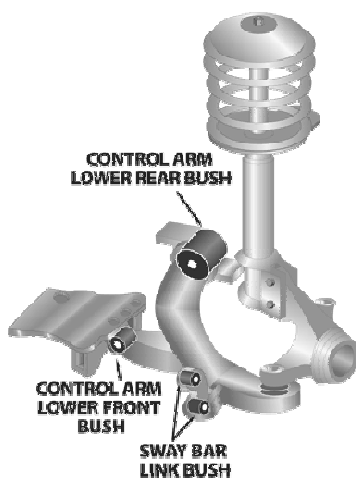

## NISSAN Pulsar / Sentra / Sunny / Almera N13 B12 Sedan &...

Página 2 (Continúa)



Aplicaci...	Descripción	Referencia	Kits por...	Contenido del Kit	
DEL.	Sway Bar Mount To Chassis Bushing Measure bar diameter 22,24,27mm available	MPU-0616-__K	1	Bushings	
TRAS.	Control Arm Lower-Inner & Outer Kit Includes 40mm long crush tubes	MPU-0862K	1	Inner Tubes, Bushings	
TRAS.	Sway Bar Mount To Chassis Bushing Measure bar diameter 24, 26.5mm available	MPU-0865-__K	1	Bushings	
TRAS.	Sway Bar To Hub Mount Bushing	MPU-0861K	1	Bushings	



## NISSAN Pulsar / Sentra / Sunny / Almera N14 B13 Sedan &...

Página 1

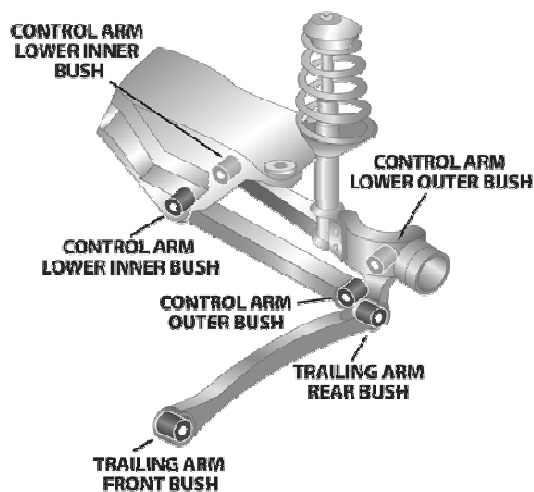
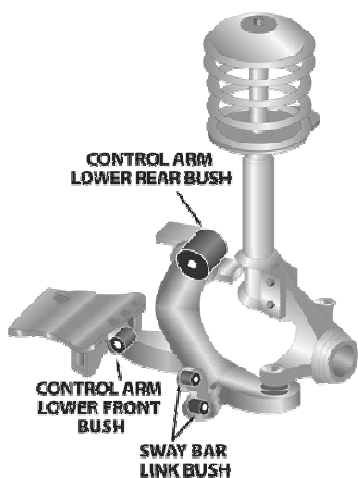







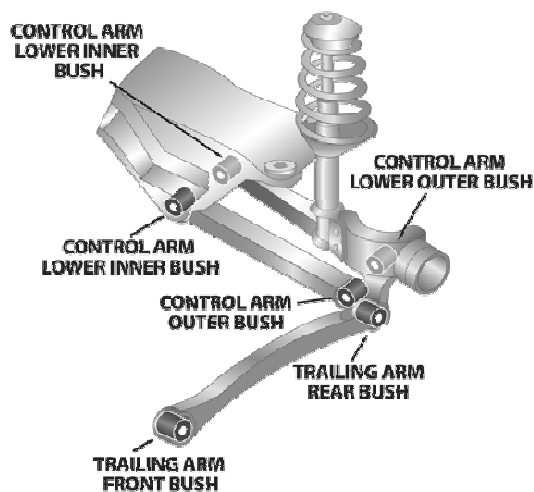
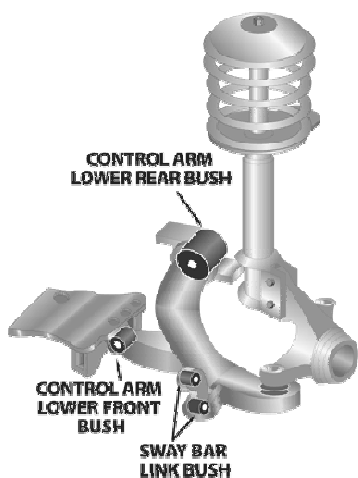

Aplicaci...	Descripción	Referencia	Kits por...	Contenido del Kit	
DEL.	Control Arm Lower Rear Bushing GTIR Import model	<b>MPU-0864K</b>	1	Bushings, Washers	
DEL.	Control Arm Lower Rear Bushing Standard setting	<b>MPU-1338K</b>	1	Bushings	
DEL.	Control Arm Lower Rear Bushing 1 x Offset 1 x Standard bushing, to adjust caster settings	<b>MPU-1339K</b>	1	Bushings	
DEL.	Control Arm Lower Rear Bushing 2 x Offset bushings, Increase positive caster both sides	<b>MPU-1340AK</b>	1	Bushings	
DEL.	Control Arm Lower Rear Bushing 2 x Offset bushings, PS increased DS decrease caster	<b>MPU-1340K</b>	1	Bushings	
DEL.	Control Arm Lower-Front Bushing	<b>MPU-1341K</b>	1	Washers, Inner Tubes, Bushings	
DEL.	Steering Rack & Pinion Mount Bush.....Power Steering Not GTIR models	<b>MPU-1834K</b>	1	Bushings	

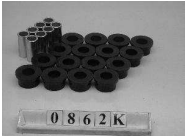

## NISSAN Pulsar / Sentra / Sunny / Almera N14 B13 Sedan &...

Página 2 (Continúa)









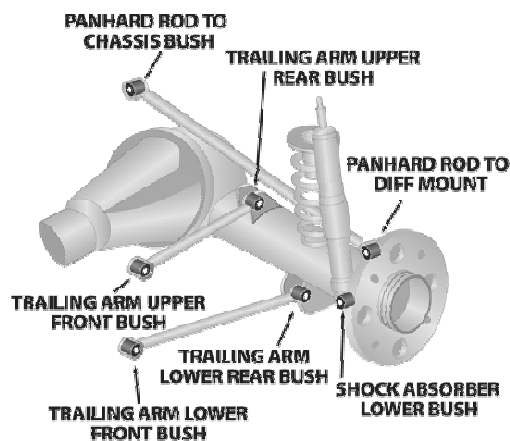
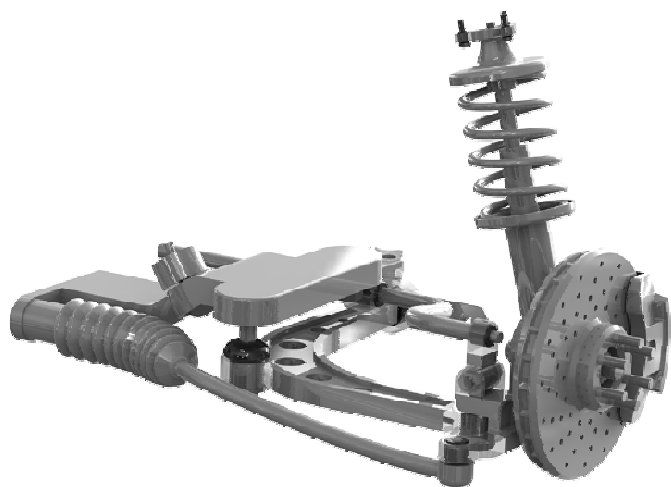

Aplicaci...	Descripción	Referencia	Kits por...	Contenido del Kit	
DEL.	Sway Bar Link Lower Bushing	MPU-2092B-4K	1	Bushings	
DEL.	Sway Bar Mount To Chassis Bushing Measure bar diameter 16,22,24,25,26,27,28mm available	MPU-1135-__K	1	Bushings	
TRAS.	Control Arm Lower-Inner & Outer Kit Includes 40mm long crush tubes	MPU-0862K	1	Inner Tubes, Bushings	
TRAS.	Sway Bar Link Upper Bushing	MPU-0903-4K	1	Bushings	
TRAS.	Sway Bar Mount To Chassis Bushing Measure bar diameter 12,13,14,16mm available	MPU-1192-__K	1	Bushings	
TRAS.	Trailing Arm - Front Bushing Not suited to GTiR models	MPU-0835-4K	1	Inner Tubes, Bushings	
TRAS.	Trailing Arm - Rear Bushing Not suited to GTiR models	MPU-0691-2K	1	Inner Tubes, Bushings	



## NISSAN Stanza A10 - 10/1978 - 9/1983

Página 1









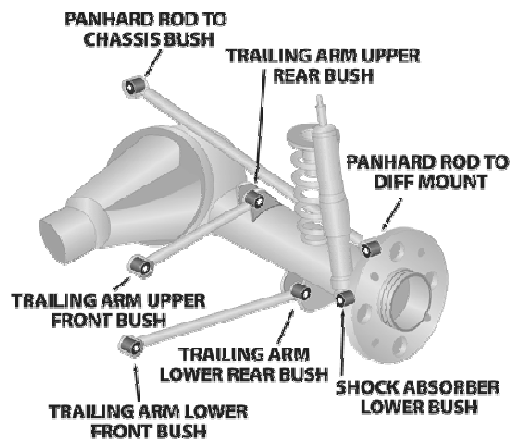
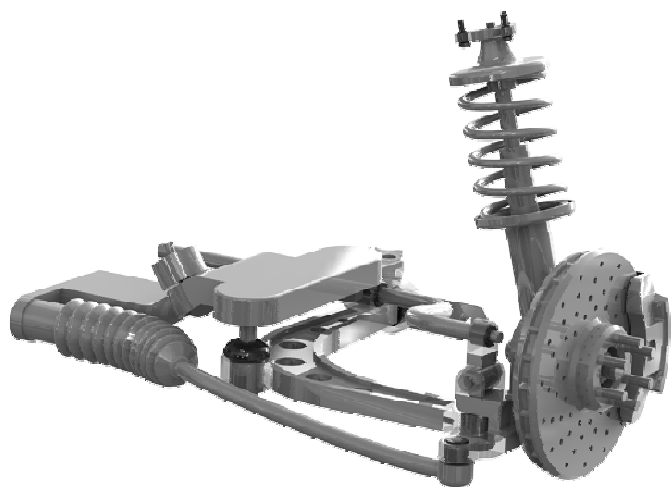

Aplicaci...	Descripción	Referencia	Kits por...	Contenido del Kit	
DEL.	Sway Bar Mount To Chassis Bushing Measure bar diameter 19,23,25mm available	MPU-0965-__K	1	Bushings	
DEL.	Control Arm Lower-Inner Bushing	MPU-1008K	1	Bushings, Inner Tubes	
DEL.	Idler Arm Bushing Tapered style bush	MPU-0602K	1	Bushings	
DEL.	Strut Bar To Chassis Mount Kit	MPU-0054K	1	Bushings	
DEL.	Sway Bar Link Bushing Kit	MPU-0903K	1	Bushings	
TRAS.	Trailing Arm Lower Bushing All	MPU-0836K	1	Bushings, Inner Tubes	
TRAS.	Trailing Arm Upper Bushing All	MPU-0835K	1	Inner Tubes, Bushings	

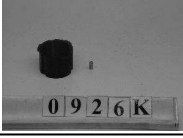

## NISSAN Sunny B11 - 1981 - 1987

Página 1



Aplicaci...	Descripción	Referencia	Kits por...	Contenido del Kit	
DEL.	Control Arm Lower Rear Bushing 35mm outside diameter, re-use original shell	<b>MPU-0958K</b>	1	Inner Tubes, Bushings	
DEL.	Control Arm Lower-Front Bushing	<b>MPU-0957K</b>	1	Bushings, Inner Tubes	
DEL.	Steering Rack & Pinion Shaft Guide.....Bush Kit	<b>MPU-0926K</b>	1	Bushings	
TRAS.	Spring Front Eye Bushing Panel van	<b>MPU-0025K</b>	1	Bushings	
TRAS.	Spring Rear Eye Bushing Panel van	<b>MPU-0854K</b>	1	Bushings	
TRAS.	Spring Shackle Upper Bushing Panel van	<b>MPU-0855K</b>	1	Bushings	





## NISSAN Sunny B310, VB310 - 3/1979 - 1981

Página 1

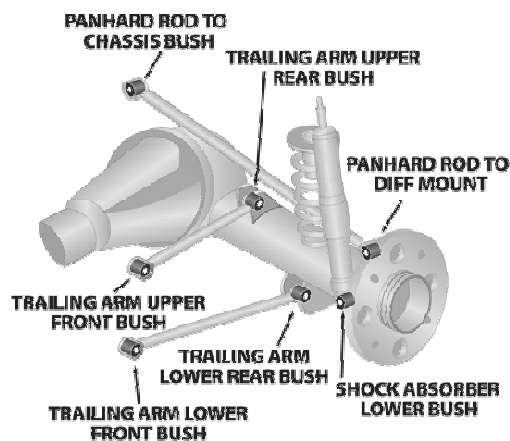
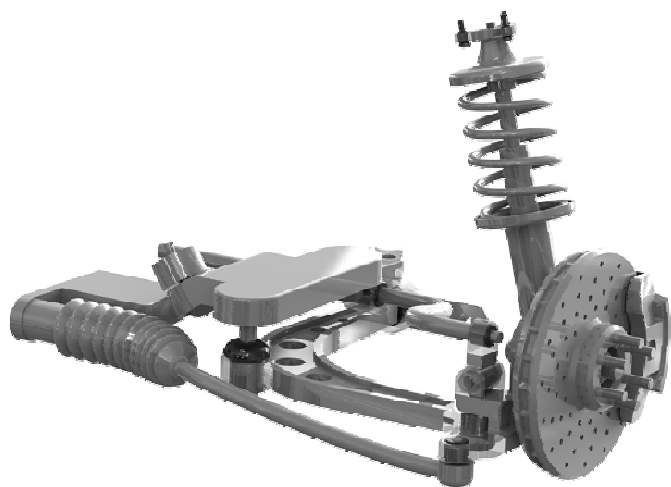

Aplicaci...	Descripción	Referencia	Kits por...	Contenido del Kit	
DEL.	Control Arm Lower-Inner Bushing	<b>MPU-1008K</b>	1	Bushings, Inner Tubes	
DEL.	Idler Arm Bushing Tapered style bush	<b>MPU-0602K</b>	1	Bushings	
DEL.	Strut Bar To Chassis Mount Kit	<b>MPU-0054K</b>	1	Bushings	
DEL.	Sway Bar Link Bushing Kit	<b>MPU-0903K</b>	1	Bushings	
DEL.	Sway Bar Mount To Chassis Bushing Measure bar diameter 20mm available	<b>MPU-1250-__K</b>	1	Bushings	
TRAS.	Shock Absorber Upper / Lower Bushing Panel van	<b>MPU-2178-16K</b>	2	Bushings	
TRAS.	Spring Front Eye Bushing Panel van	<b>MPU-0025K</b>	1	Bushings	



**NISSAN Sunny B310, VB310 - 3/1979 - 1981**

Página 2 (Continúa)

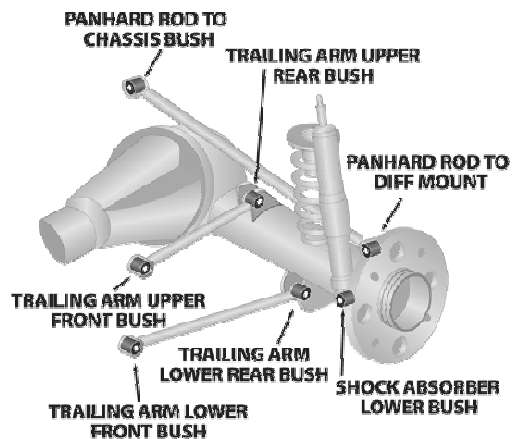
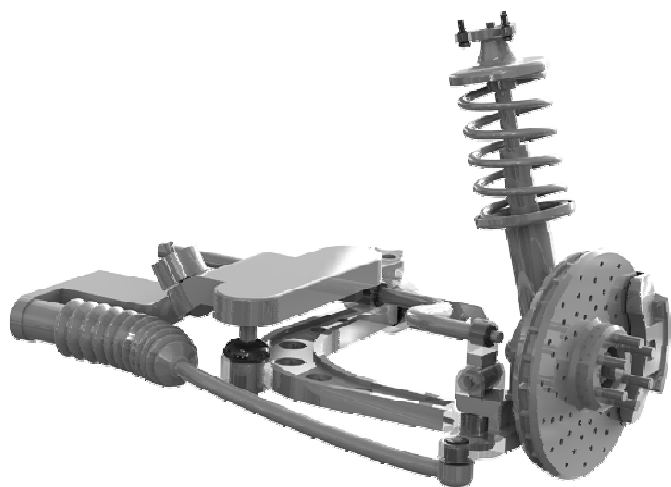







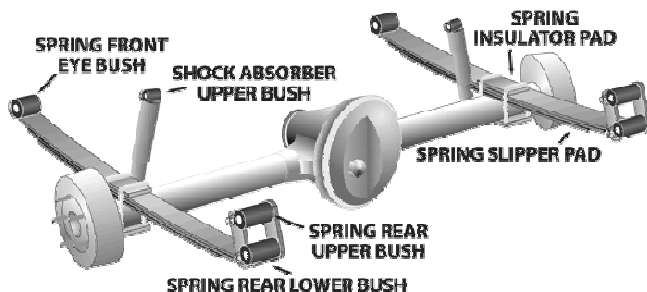
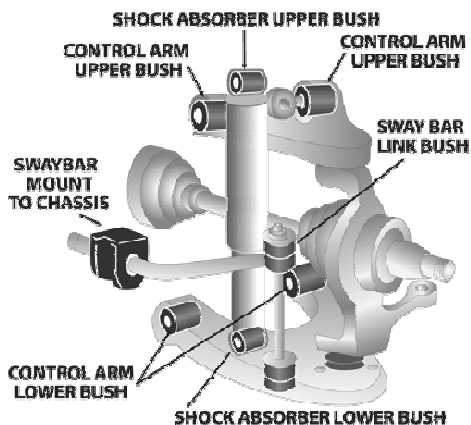

Aplicaci...	Descripción	Referencia	Kits por...	Contenido del Kit	
TRAS.	Spring Rear Eye Bushing Panel van	<b>MPU-0854K</b>	1	Bushings	
TRAS.	Spring Shackle Upper Bushing Panel van	<b>MPU-0855K</b>	1	Bushings	
TRAS.	Trailing Arm Lower Bushing All B310 sedan, station wagon	<b>MPU-0836K</b>	1	Bushings, Inner Tubes	
TRAS.	Trailing Arm Upper Bushing All B310 sedan, station wagon	<b>MPU-0835K</b>	1	Inner Tubes, Bushings	



NISSAN 620 2WD 1500 Cab Chassis - 7/1972 - 3/1978

Página 1









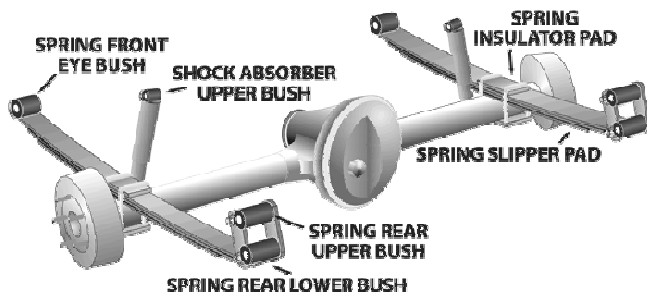
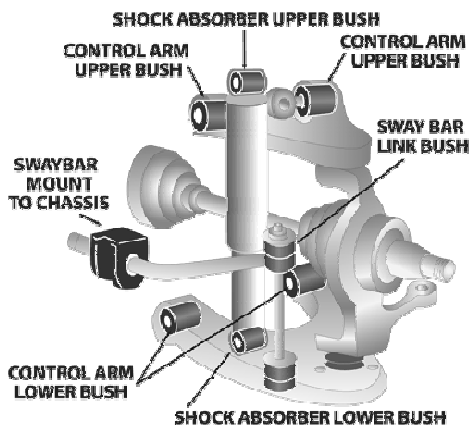

Aplicaci...	Descripción	Referencia	Kits por...	Contenido del Kit	
DEL.	Strut Bar To Chassis Mount Kit	MPU-0054K	1	Bushings	
DEL.	Shock Absorber Upper Bushing	MPU-2755SK	1	Bushings	
TRAS.	Spring Rear Eye Bushing	MPU-0056-4K	1	Bushings	
TRAS.	Spring Shackle Upper Bushing	MPU-0228-4K	1	Bushings	
TRAS.	Shock Absorber Lower Bushing	MPU-0094K	1	Bushings	
TRAS.	Shock Absorber Upper Bushing	MPU-2178-16K	1	Bushings	
TRAS.	Spring Front Eye Bushing	MPU-0055K	1	Bushings	



NISSAN 720 2WD & 4WD Cab Chassis - 1/1980 - 12/1985

Página 1









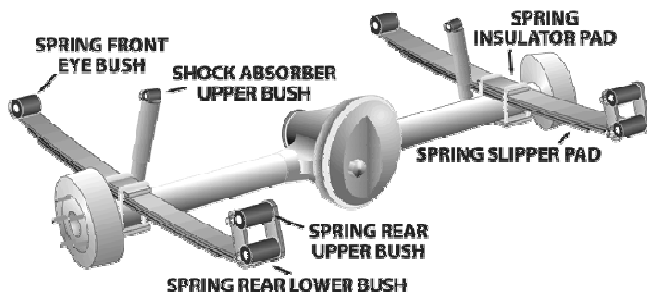
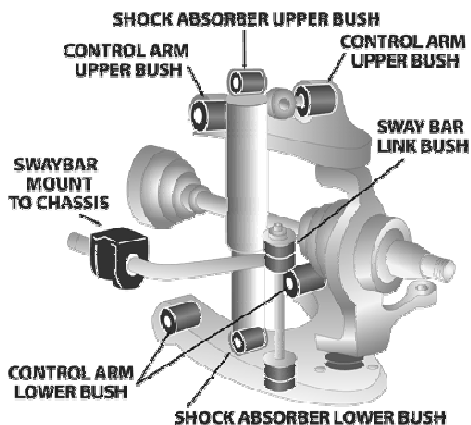

Aplicaci...	Descripción	Referencia	Kits por...	Contenido del Kit	
DEL.	Control Arm Lower Rear Bushing 4WD	MPU-0148K	1	Inner Tubes, Bushings	
DEL.	Control Arm Lower-Front Bushing 4WD	MPU-1162K	1	Bushings, Inner Tubes	
DEL.	Control Arm Upper-Inner Kit Re-use original shell	MPU-0879K	1	Inner Tubes, Bushings	
DEL.	Idler Arm Bushing 2WD 16mm inside diameter only, "Tapered style bush"	MPU-0602K	1	Bushings	
DEL.	Idler Arm Bushing 5/1982 On "Straight style bush"	MPU-1288K	1	Bushings	
DEL.	Shock Absorber Upper Bushing	MPU-2755SK	1	Bushings	
DEL.	Strut Bar To Chassis Mount Kit 2WD	MPU-0148K	1	Inner Tubes, Bushings	



**NISSAN 720 2WD & 4WD Cab Chassis - 1/1980 - 12/1985**

Página 2 (Continúa)









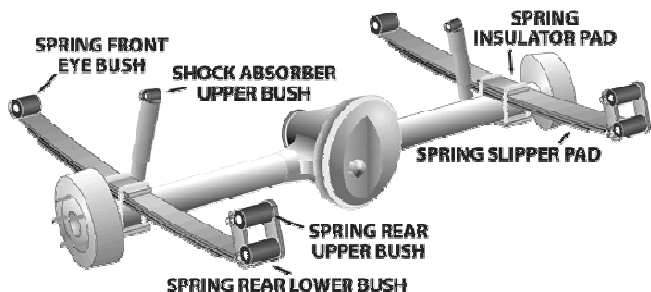
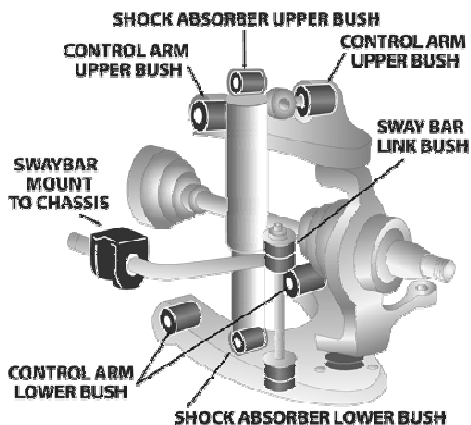

Aplicaci...	Descripción	Referencia	Kits por...	Contenido del Kit	
DEL.	Sway Bar Link Bushing Kit	<b>MPU-2092BK</b>	1	Bushings	 SPF2092BK
DEL.	Sway Bar Mount To Chassis Bushing 2WD & 4WD Measure bar diameter, 19,21,22,24 available	<b>MPU-0604_ _K</b>	1	Bushings	
TRAS.	Shock Absorber Lower Bushing Pin mount	<b>MPU-0094K</b>	1	Bushings	 0094K
TRAS.	Shock Absorber Lower Bushing Eye mount	<b>MPU-2178-16K</b>	1	Bushings	 SPF2178- K
TRAS.	Shock Absorber Upper Bushing	<b>MPU-2178-16K</b>	1	Bushings	 SPF2178- K
TRAS.	Spring Front Eye Bushing	<b>MPU-0055K</b>	1	Bushings	 0055K
TRAS.	Spring Rear Bushing All	<b>MPU-0056K</b>	1	Bushings	 0056K



**NISSAN Vanette C120/C122, Nomad, Serena - 7/1982 - 12/1993**

Página 1









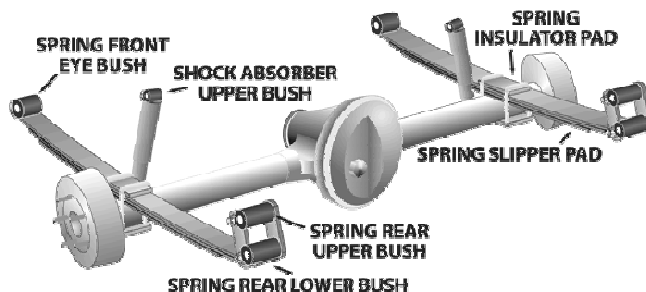
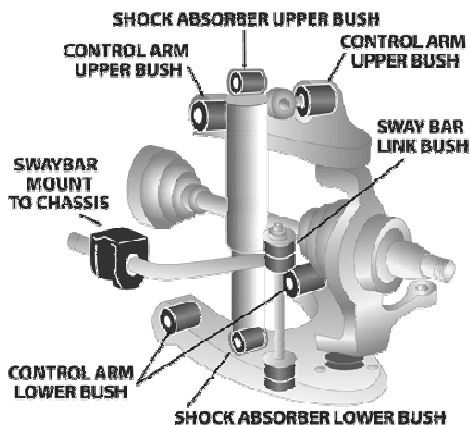

Aplicaci...	Descripción	Referencia	Kits por...	Contenido del Kit	
DEL.	Control Arm Upper-Inner Kit	<b>MPU-1885K</b>	1	Inner Tubes, Bushings	
DEL.	Idler Arm Bushing Straight style bush	<b>MPU-1288K</b>	1	Bushings	
DEL.	Shock Absorber Lower Bushing	<b>MPU-2178-16K</b>	1	Bushings	
TRAS.	Shock Absorber Upper / Lower Bushing	<b>MPU-2178-16K</b>	1	Bushings	
TRAS.	Spring Front Eye Bushing	<b>MPU-0259K</b>	1	Bushings	
TRAS.	Spring Rear Bushing All Replaces origina bushing 55046-G2500	<b>MPU-0786K</b>	1	Bushings	

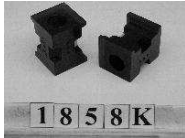

NISSAN Nomad C22, C23 Wagon, Serena, Vanette - 12/1986 - ...

Página 1







Aplicaci...	Descripción	Referencia	Kits por...	Contenido del Kit	
DEL.	Control Arm Upper-Inner Kit	MPU-1885K	1	Inner Tubes, Bushings	
DEL.	Idler Arm Bushing LHS only, Straight style bush	MPU-1288K	1	Bushings	
DEL.	Strut Bar To Chassis Mount Kit	MPU-0927K	1	Bushings	
DEL.	Sway Bar To Lower Control Arm Kit One size fits all	MPU-1858K	1	Bushings	
TRAS.	Shock Absorber Upper / Lower Bushing	MPU-2178-16K	2	Bushings	
TRAS.	Spring Front Eye Bushing Leaf spring model	MPU-0259K	1	Bushings	
TRAS.	Spring Rear Bushing All Leaf spring model, replaces original number 55046-G8300	MPU-0786K	1	Bushings	

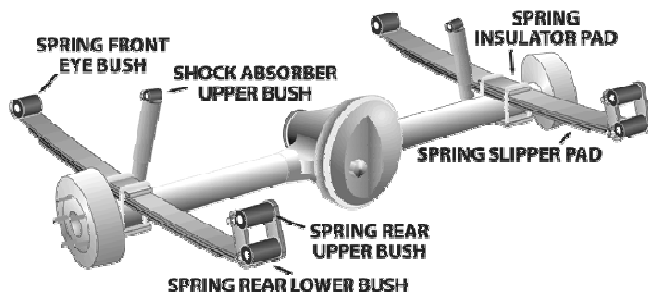
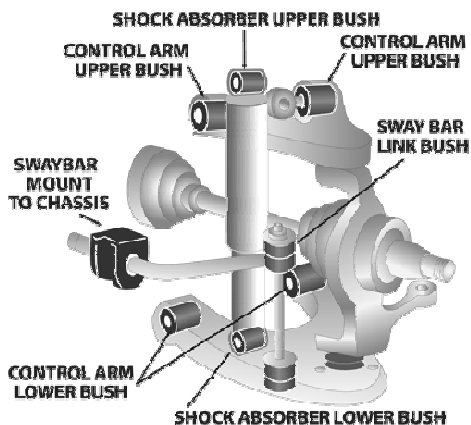

**NISSAN Nomad C22, C23 Wagon, Serena, Vanette - 12/1986 - ...**

Página 2 (Continúa)



Aplicaci...	Descripción	Referencia	Kits por...	Contenido del Kit	
TRAS.	Trailing Arm Lower Bushing All Coil spring model	<b>MPU-1247K</b>	1	Inner Tubes, Bushings	
TRAS.	Trailing Arm Upper Bushing All Coil spring model	<b>MPU-1247K</b>	1	Inner Tubes, Bushings	





NISSAN Pathfinder 4WD R50, Infiniti QX4, Wagon - 11/1995 -...

Página 1

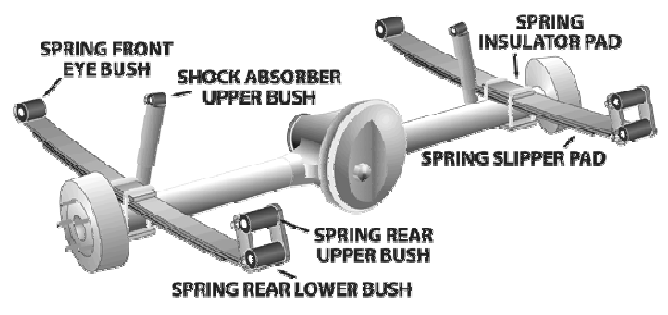
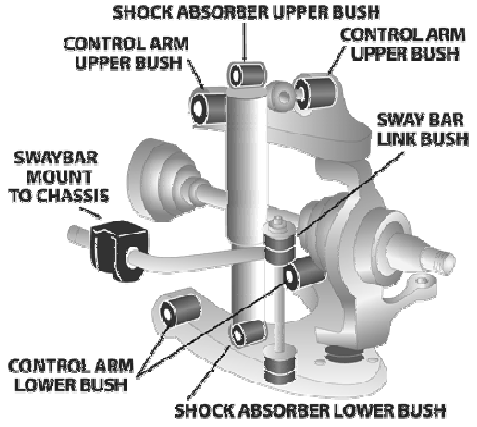

Aplicaci...	Descripción	Referencia	Kits por...	Contenido del Kit	
DEL.	Control Arm Lower-Inner Front Kit	MPU-2036K	1	Inner Tubes, Bushings	
DEL.	Control Arm Lower-Inner Rear Kit Standard	MPU-2037K	1	Bushings	
DEL.	Control Arm Lower-Inner Rear Kit Single offset	MPU-2038K	1	Bushings	
DEL.	Control Arm Lower-Inner Rear Kit Double offset	MPU-2039K	1	Bushings	
DEL.	Sway Bar Mount To Chassis Bushing Please measure bar diameter	MPU-1484-__K	1	Bushings	
TRAS.	Panhard Rod Bushing	MPU-1248K	1	Inner Tubes, Bushings	
TRAS.	Sway Bar Link Upper Bushing	MPU-2092B-4K	1	Bushings	



**NISSAN Pathfinder 4WD R50, Infiniti QX4, Wagon - 11/1995 -...**

Página 2 (Continúa)

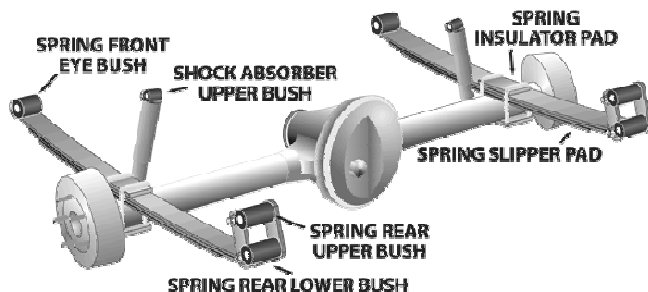
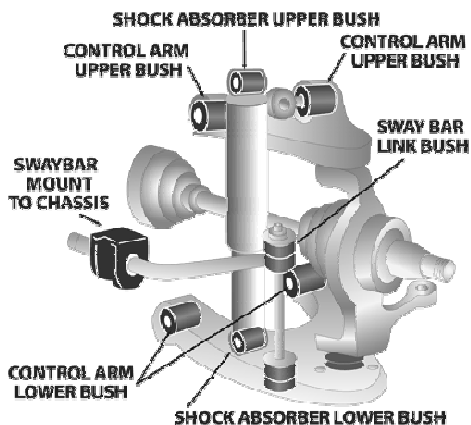









Aplicaci...	Descripción	Referencia	Kits por...	Contenido del Kit	
TRAS.	Sway Bar Mount to Axle Bushing Measure bar diameter 12,13,14,15,16,18,20mm available	<b>MPU-1192-__K</b>	1	Bushings	
TRAS.	Trailing Arm Lower Bushing All	<b>MPU-0399K</b>	2	Inner Tubes, Bushings	
TRAS.	Trailing Arm Upper Bushing All	<b>MPU-0399K</b>	2	Inner Tubes, Bushings	



## NISSAN Pathfinder 4WD R51 - 2005 - 2012

Página 1







Aplicaci...	Descripción	Referencia	Kits por...	Contenido del Kit	
DEL.	Control Arm Lower-Inner Bushing Standard replacement.	<b>MPU-3023K</b>	1	Outer Shells, Inner Tubes, Bushings	
DEL.	Control Arm Lower-Inner Eccentric Kit Offset.	<b>MPU-3024K</b>	1	Outer Shells, Inner Tubes, Bushings	
DEL.	Control Arm Lower-Inner Eccentric Kit 4 x offset bushings & 4 x offset tubes, for use where max adjustment is needed.	<b>MPU-3024XK</b>	1	Outer Shells, Inner Tubes, Bushings	
DEL.	Control Arm Upper-Inner Eccentric Kit Offset tubes to aid in camber adjustment in raised vehicles.	<b>MPU-3022XK</b>	1	Inst Sheet, Outer Shells, Inner Tubes, Bushings	
DEL.	Control Arm Upper-Inner Kit Standard replacement.	<b>MPU-3022K</b>	1	Inst Sheet, Outer Shells, Inner Tubes, Bushings	
TRAS.	Control Arm Lower-Inner Bushing Standard replacement.	<b>MPU-3974K</b>	1	Inst Sheet, Outer Shells, Inner Tubes, Bushings	
TRAS.	Control Arm Lower-Inner Eccentric Kit Offset.	<b>MPU-3975K</b>	1	Inst Sheet, Outer Shells, Inner Tubes, Bushings	

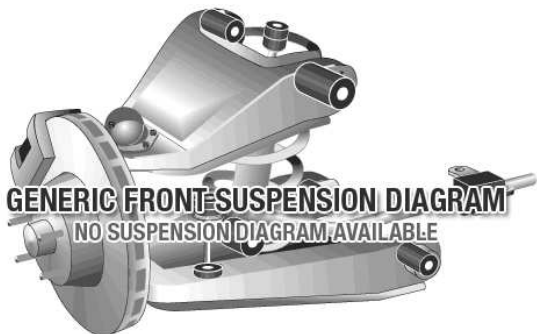

## NISSAN Pathfinder 4WD R51 - 2005 - 2012

Página 2 (Continúa)









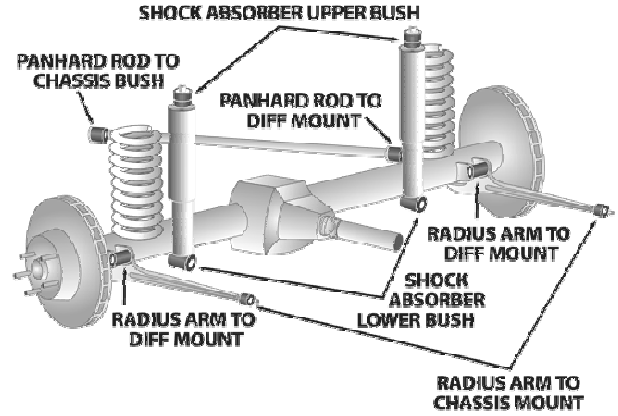
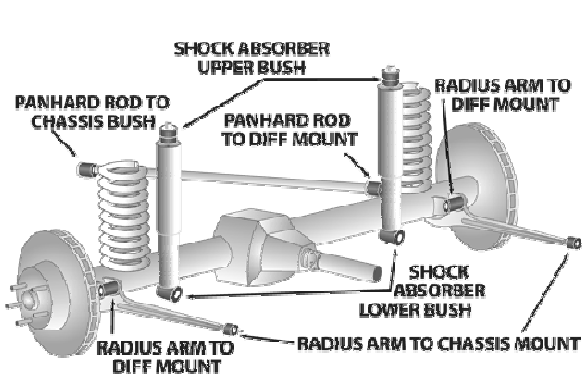

Aplicaci...	Descripción	Referencia	Kits por...	Contenido del Kit	
TRAS.	Control Arm Upper-Inner Bushing Standard replacement.	<b>MPU-3976K</b>	1	Inst Sheet, Outer Shells, Inner Tubes, Bushings	
TRAS.	Control Arm Upper-Inner Eccentric Kit Offset.	<b>MPU-3977K</b>	1	Inst Sheet, Outer Shells, Inner Tubes, Bushings	



## NISSAN Patrol Y60 & Y61 Series, Cab Chassis Leaf Spring,...

Página 1







Aplicaci...	Descripción	Referencia	Kits por...	Contenido del Kit	
DEL.	Leaf Spring Bushing All "H" Kits for Severe Conditions or Heavy Duty applications	MPU-0978HK	1	Bushings	
DEL.	Leaf Spring Bushing All	MPU-0978K	1	Bushings	
DEL.	Shock Absorber Upper Bushing	MPU-0078K	1	Bushings	
DEL.	Sway Bar Link Bushing Kit	MPU-2092BK	1	Bushings	
DEL.	Sway Bar Mount To Axle Bushing Measure bar diameter 15,18,20,22,24mm available	MPU-0626-__K	1	Bushings	
F & R	Leaf Spring Bushing All SPF0978K x 1,SPF2260K x 1	MPK-067K	1		
TRAS.	Shock Absorber Lower Bushing	MPU-2755LK	1	Bushings	

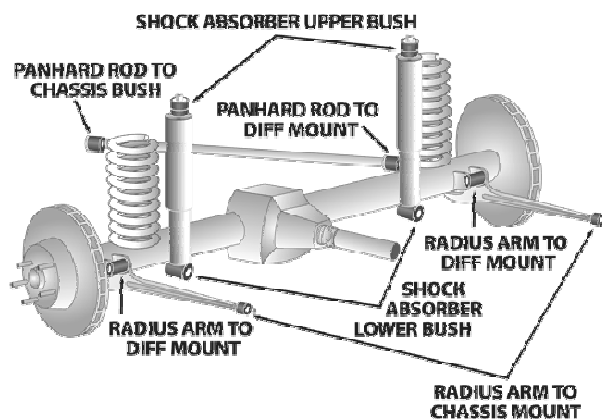
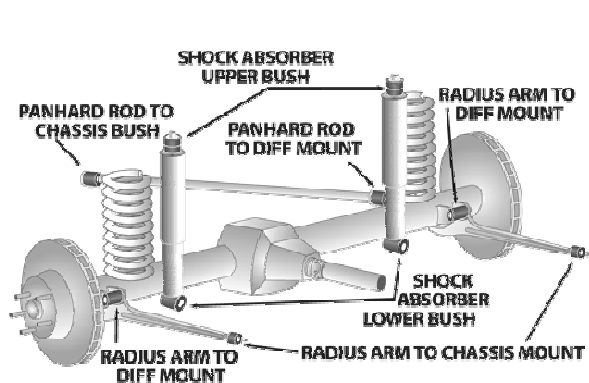

## NISSAN Patrol Y60 & Y61 Series, Cab Chassis Leaf Spring,...

Página 2 (Continúa)









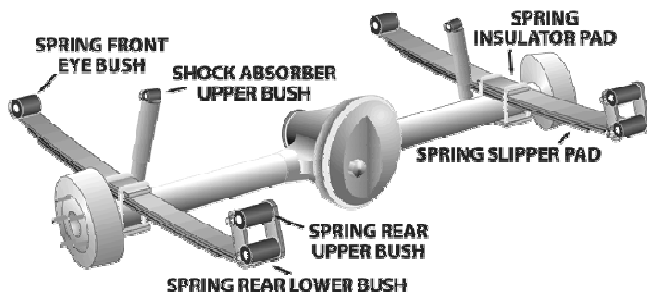
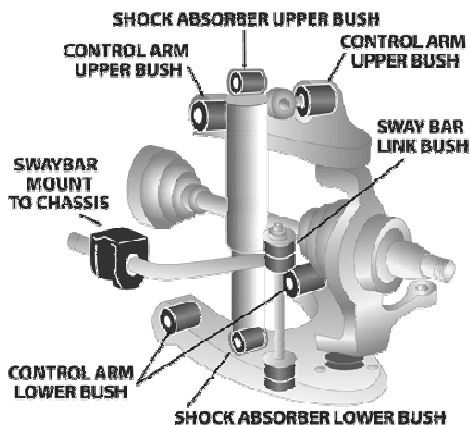

Aplicaci...	Descripción	Referencia	Kits por...	Contenido del Kit	
TRAS.	Spring Rear Bushing All "H" Kits for Severe Conditions or Heavy Duty applications, New design to suit greasable shackles	<b>MPU-2260HK</b>	1	Bushings	
TRAS.	Spring Rear Bushing All New design to suit greasable shackles	<b>MPU-2260K</b>	1	Bushings	



**NISSAN Urvan E20 - 1973 - 1980**

Página 1



Aplicaci...	Descripción	Referencia	Kits por...	Contenido del Kit	
DEL.	Shock Absorber Upper Bushing	<b>MPU-2755SK</b>	1	Bushings	
DEL.	Strut Bar To Chassis Mount Kit	<b>MPU-1158K</b>	1	Bushings	
TRAS.	Shock Absorber Lower Bushing	<b>MPU-2937K</b>	1	Bushings	
TRAS.	Shock Absorber Upper Bushing	<b>MPU-2178-16K</b>	1	Bushings	
TRAS.	Spring Rear Bushing All No tube supplied in kit OE # 55046-07200	<b>MPU-0228K</b>	1	Bushings	
TRAS.	Spring Rear Bushing All Kit supplied with crush tube OE # 55046-B8460	<b>MPU-1136K</b>	1	Bushings, Inner Tubes	



**NISSAN Urvan E23 - 1981 - 2/1987**

Página 1

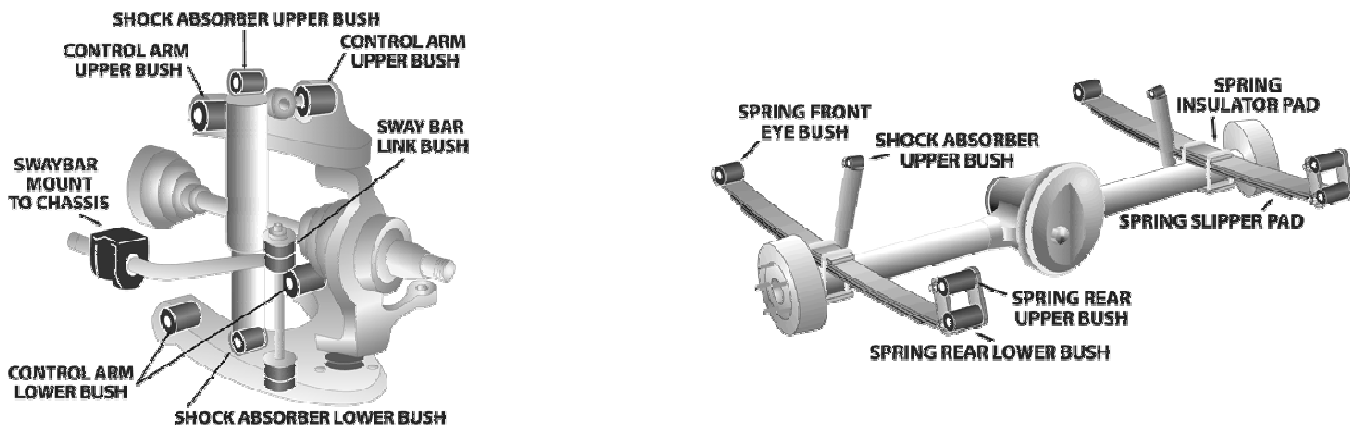

Aplicaci...	Descripción	Referencia	Kits por...	Contenido del Kit	
DEL.	Control Arm Upper-Inner Kit	<b>MPU-0879K</b>	1	Inner Tubes, Bushings	
DEL.	Shock Absorber Upper Bushing	<b>MPU-2755SK</b>	1	Bushings	
DEL.	Spring Rear Lower Bushing	<b>MPU-0055K</b>	1	Bushings	
DEL.	Strut Bar To Chassis Mount Kit	<b>MPU-0148K</b>	1	Inner Tubes, Bushings	
DEL.	Sway Bar Link Bushing Kit	<b>MPU-2092BK</b>	1	Bushings	
TRAS.	Leaf Spring Front Support Bracket Kit Triangle shaped bracket	<b>MPU-0260K</b>	1	Bushings	
TRAS.	Shock Absorber Lower Bushing	<b>MPU-2937K</b>	1	Bushings	







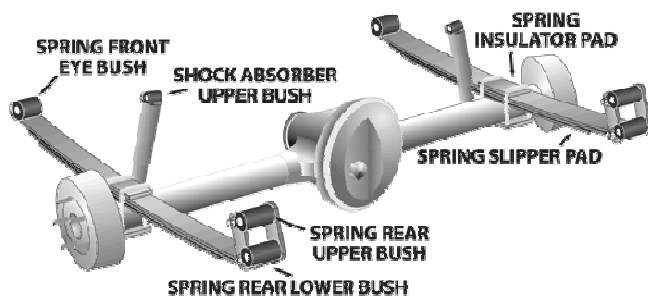
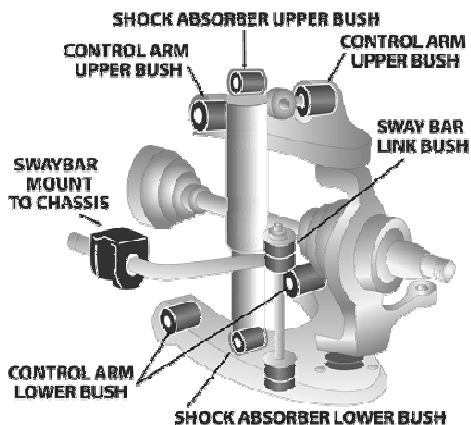

**NISSAN Urvan E23 - 1981 - 2/1987**

Página 2 (Continúa)



Aplicaci...	Descripción	Referencia	Kits por...	Contenido del Kit	
TRAS.	Shock Absorber Upper Bushing	<b>MPU-2178-16K</b>	1	Bushings	
TRAS.	Spring Rear Lower Bushing	<b>MPU-0055K</b>	1	Bushings	
TRAS.	Spring Rear Upper Shackle Bushing	<b>MPU-2052K</b>	1	Bushings	



**NISSAN Urvan E24 - 1987 - 2001**

Página 1

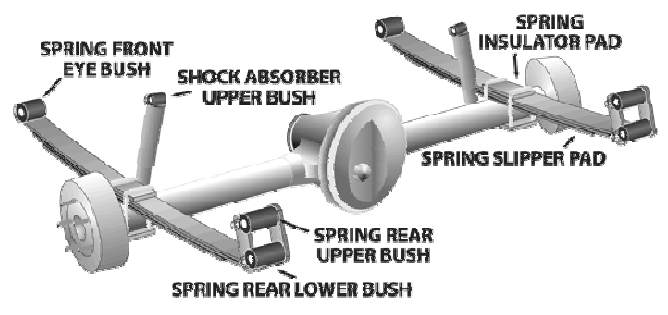
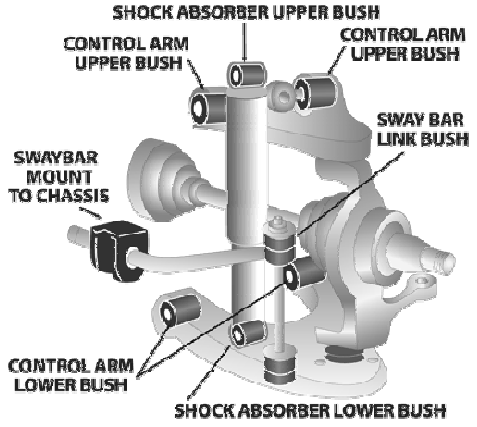







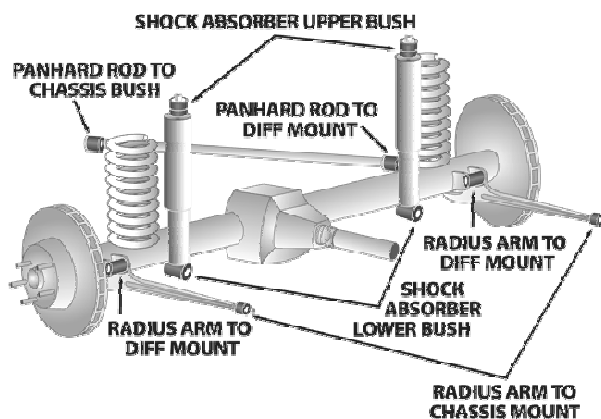
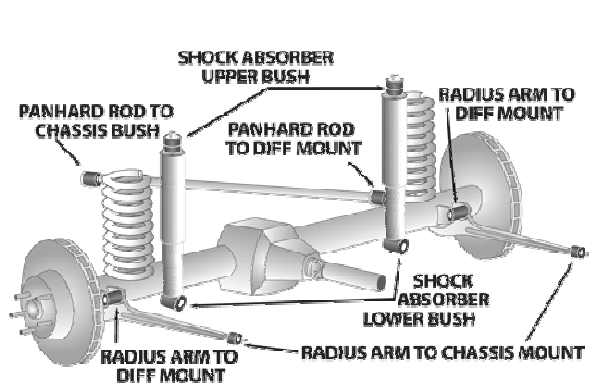

Aplicaci...	Descripción	Referencia	Kits por...	Contenido del Kit	
DEL.	Control Arm Upper-Inner Kit	<b>MPU-0879K</b>	1	Inner Tubes, Bushings	
DEL.	Strut Bar To Chassis Mount Kit	<b>MPU-0881K</b>	1	Inner Tubes, Bushings	
DEL.	Sway Bar Link Bushing Kit	<b>MPU-2092BK</b>	1	Bushings	
TRAS.	Shock Absorber Upper / Lower Bushing	<b>MPU-2178-16K</b>	2	Bushings	
TRAS.	Spring Front Eye Bushing OE# 55045-01N00	<b>MPU-2094K</b>	1	Bushings, Inner Tubes	
TRAS.	Spring Rear Bushing All	<b>MPU-0817K</b>	1	Bushings	



## NISSAN Patrol Y61 Series GU Wagon / Safari - 12/1997 - 2013

Página 1



Aplicaci...	Descripción	Referencia	Kits por...	Contenido del Kit	
DEL.	Coil Spring Spacer Bushing Raises vehicle approximately 15mm	<b>MPU-1734K</b>	2	Bushings	
DEL.	Coil Spring Spacer Bushing Raises vehicle approximately 30mm	<b>MPU-2364-30K</b>	2	Bushings	
DEL.	Panhard Rod Bushing	<b>MPU-0398K</b>	1	Inner Tubes, Bushings	
DEL.	Panhard Rod Bushing Series 3 (Spherical bearing style at chassis end)	<b>MPU-2344K</b>	1	Bushings, Inner Tubes	
DEL.	Radius Arm To - Chassis Kit	<b>MPU-0397K</b>	1	Bushings	
DEL.	Radius Arm To - Chassis, Setback Kit Alignment correction kit	<b>MPU-3467K</b>	1	Inst Sheet, Bushings	
DEL.	Radius Arm To - Diff Mount - Eccentric Kit Offset centre hole to increase caster settings	<b>MPU-1721K</b>	1	Inst Sheet, Outer Shells, Inner Tubes, Bushings	



## NISSAN Patrol Y61 Series GU Wagon / Safari - 12/1997 - 2013

Página 2 (Continúa)

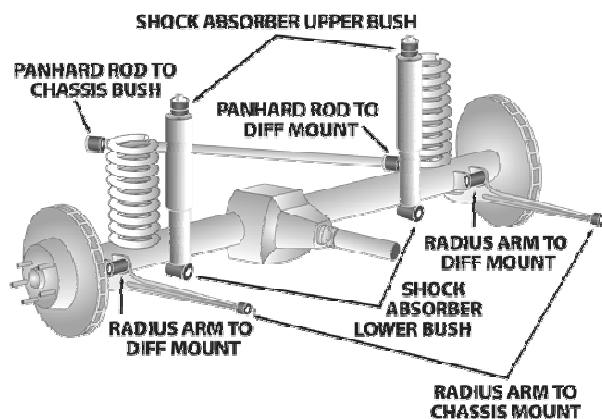
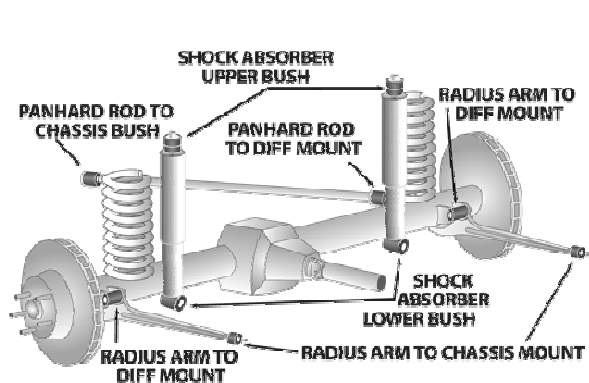

Aplicaci...	Descripción	Referencia	Kits por...	Contenido del Kit	
DEL.	Radius Arm To - Diff Mount - Eccentric Kit Extra offset "High Lift Vehicles" To increase caster settings	<b>MPU-1721XK</b>	1	Inst Sheet, Outer Shells, Inner Tubes, Bushings	
DEL.	Radius Arm To - Diff Mount Bushing	<b>MPU-0396K</b>	1	Inner Tubes, Bushings	
DEL.	Shock Absorber Upper / Lower Bushing	<b>MPU-0740K</b>	2	Bushings	
DEL.	Sway Bar Link Bushing Kit	<b>MPU-2092BK</b>	1	Bushings	
DEL.	Sway Bar Mount To Axle Bushing Flat Bracket, Up to 2002, Measure bar diameter 15,18,20,22,24mm available	<b>MPU-0626-__K</b>	1	Bushings	
DEL.	Sway Bar Mount To Axle Bushing Ribbed Bracket (2002-on); Please measure bar diameter	<b>MPU-1484-__K</b>	1	Bushings	
F & R	Radius Arms & Panhard Rods Bush Kit Vehicles with standard bushings both ends of the panhard rods	<b>MPK-060K</b>	1		



NISSAN Patrol Y61 Series GU Wagon / Safari - 12/1997 - 2013

Página 3 (Continúa)

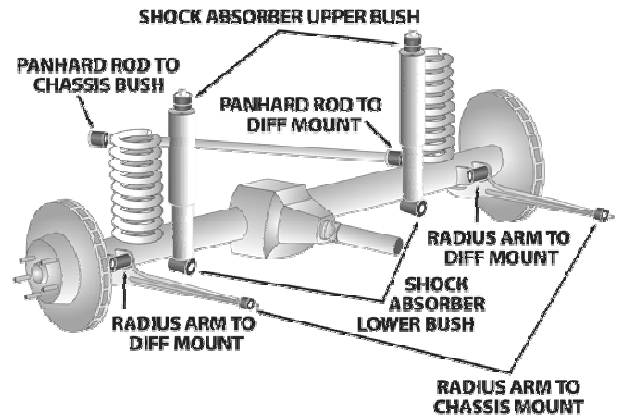
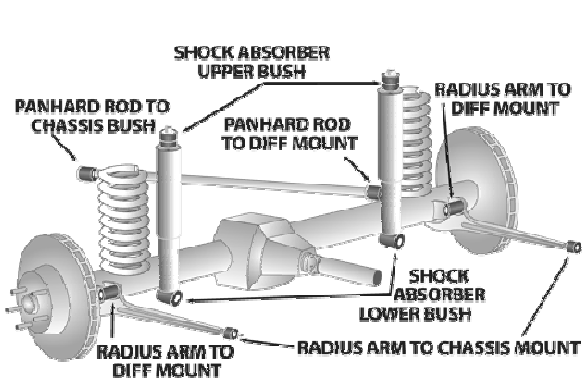





Aplicaci...	Descripción	Referencia	Kits por...	Contenido del Kit	
F & R	Radius Arms & Panhard Rods Bush Kit Vehicles with spherical ends on chassis end of panhard rods	<b>MPK-107K</b>	1		
TRAS.	Coil Spring Spacer Bushing Raises vehicle approximately 15mm	<b>MPU-1736-15K</b>	2	Bushings	
TRAS.	Coil Spring Spacer Bushing Raises vehicle approximately 30mm	<b>MPU-1736-30K</b>	2	Bushings	
TRAS.	Panhard Rod Bushing	<b>MPU-0398K</b>	1	Inner Tubes, Bushings	
TRAS.	Panhard Rod Bushing Series 3 (Spherical bearing style at chassis end)	<b>MPU-2344K</b>	1	Bushings, Inner Tubes	
TRAS.	Sway Bar Link Bushing Kit	<b>MPU-2092B-4K</b>	1	Bushings	
TRAS.	Sway Bar Mount To Axle Bushing Measure bar diameter 17,18,19,20 & 25mm available.	<b>MPU-1481-__K</b>	1	Bushings	

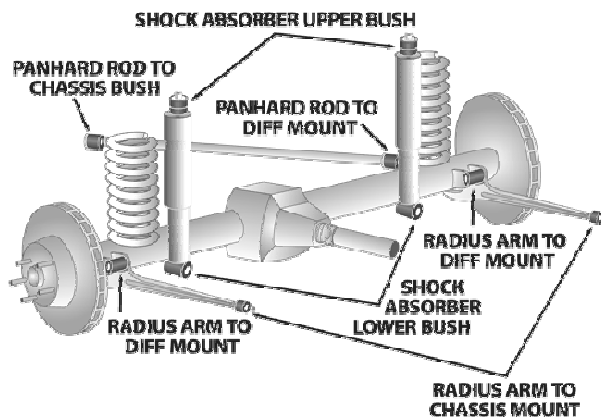
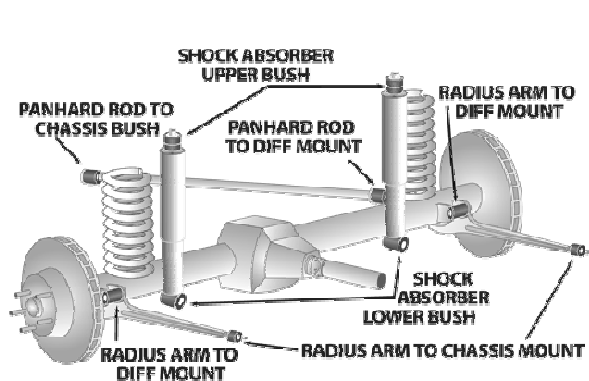

**NISSAN Patrol Y61 Series GU Wagon / Safari - 12/1997 - 2013**

Página 4 (Continúa)









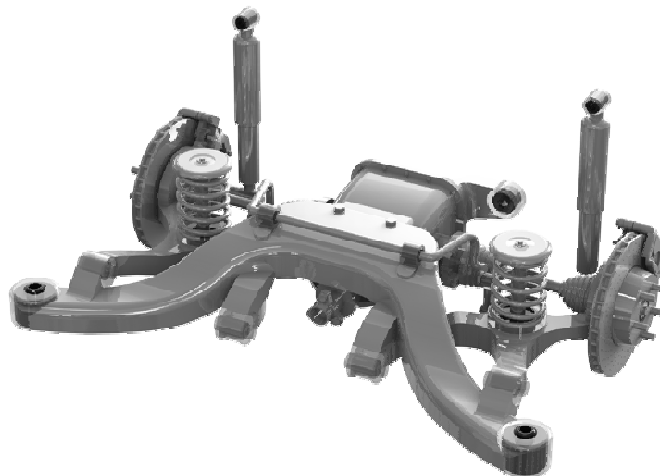
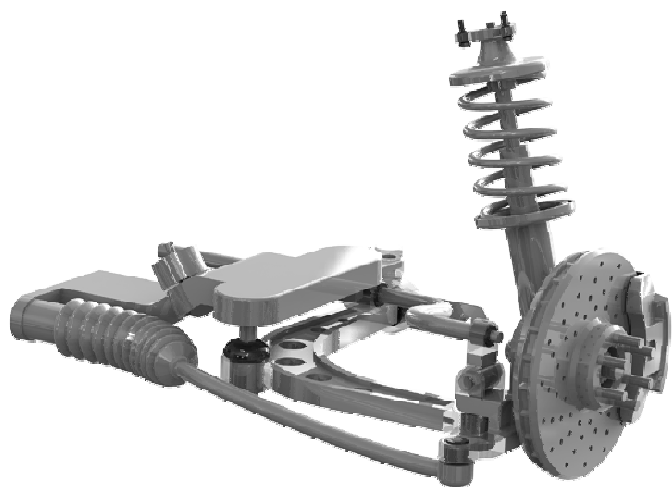

Aplicaci...	Descripción	Referencia	Kits por...	Contenido del Kit	
TRAS.	Trailing Arm Lower Bushing All	<b>MPU-0399K</b>	2	Inner Tubes, Bushings	 SPF0399K
TRAS.	Trailing Arm Upper Bushing All	<b>MPU-0399K</b>	2	Inner Tubes, Bushings	 SPF0399K



## NISSAN 280ZX (Fairlady) Coupe - 1978 - 1984

Página 1



Aplicaci...	Descripción	Referencia	Kits por...	Contenido del Kit	
DEL.	Control Arm-Inner Bushing	<b>MPU-0562K</b>	1	Bushings, Inner Tubes	
DEL.	Idler Arm Bushing	<b>MPU-1003K</b>	1	Bushings	
DEL.	Strut Bar To Chassis Mount Kit	<b>MPU-0927K</b>	1	Bushings	
DEL.	Sway Bar Link Bushing Kit	<b>MPU-2092BK</b>	1	Bushings	
DEL.	Sway Bar Mount To Chassis Bushing Bar dia14,16,17,18,19,20,21,22,23,24,25,26,27 available	<b>MPU-1452-__K</b>	1	Bushings	
TRAS.	Control Arm Lower-Inner Bushing	<b>MPU-0561K</b>	1	Inner Tubes, Bushings	
TRAS.	Sway Bar Link Bushing Kit	<b>MPU-0903K</b>	1	Bushings	

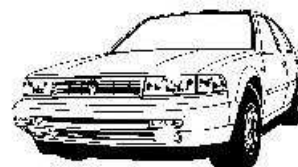

## NISSAN Maxima HJ30, Series - 5/1990 - 1/1995

Página 1

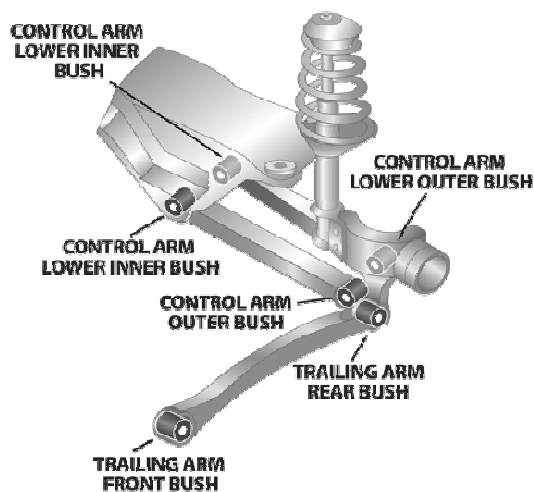
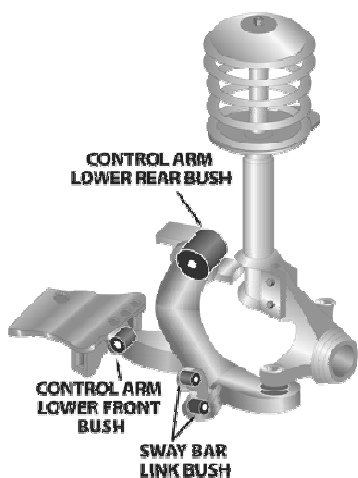

Aplicaci...	Descripción	Referencia	Kits por...	Contenido del Kit	
DEL.	Control Arm Lower Rear Bushing PS & DS standard setting (Large "D" style bush design)	<b>MPU-1230K</b>	1	Washers, Bushings	
DEL.	Control Arm Lower Rear Bushing PS increase DS standard caster (Large "D" style bush)	<b>MPU-1371K</b>	1	Washers, Bushings	
DEL.	Control Arm Lower Rear Bushing PS increase DS increase caster (Large "D" style bush)	<b>MPU-1372AK</b>	1	Washers, Bushings	
DEL.	Control Arm Lower Rear Bushing PS increase DS decrease caster (Large "D" style bush)	<b>MPU-1372K</b>	1	Washers, Bushings	
DEL.	Control Arm Lower-Front Bushing Tube = 18mm ID, 47.5mm long	<b>MPU-1217K</b>	1	Washers, Inner Tubes, Bushings	
DEL.	Sway Bar Link Bushing Kit	<b>MPU-2092BK</b>	1	Bushings	
DEL.	Sway Bar Mount To Chassis Bushing Measure bar diameter 16,22,24,25,26,27,28mm available	<b>MPU-1135-__K</b>	1	Bushings	



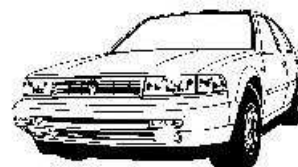



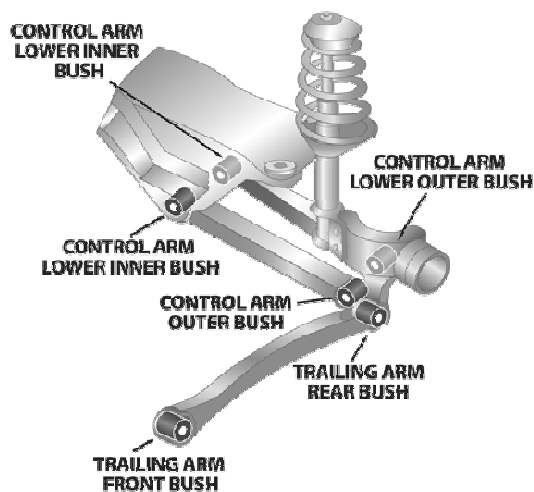
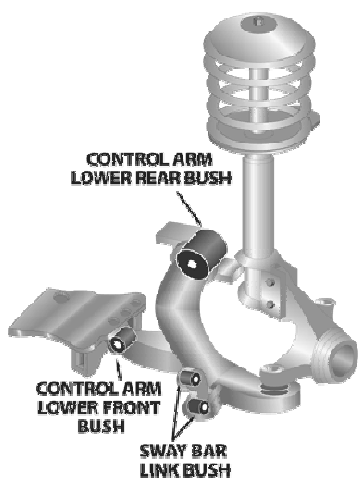

**NISSAN Maxima HJ30, Series - 5/1990 - 1/1995**

Página 2 (Continúa)









Aplicaci...	Descripción	Referencia	Kits por...	Contenido del Kit	
TRAS.	Control Arm-Bush Kit	<b>MPU-0691K</b>	1	Inner Tubes, Bushings	
TRAS.	Sway Bar Link Bushing Kit	<b>MPU-0903K</b>	1	Bushings	
TRAS.	Sway Bar Mount To Chassis Bushing Measure bar diameter 15,16,18mm available	<b>MPU-1108-__K</b>	1	Bushings	
TRAS.	Trailing Arm - Bushing Kit	<b>MPU-0959K</b>	1	Inner Tubes, Bushings	

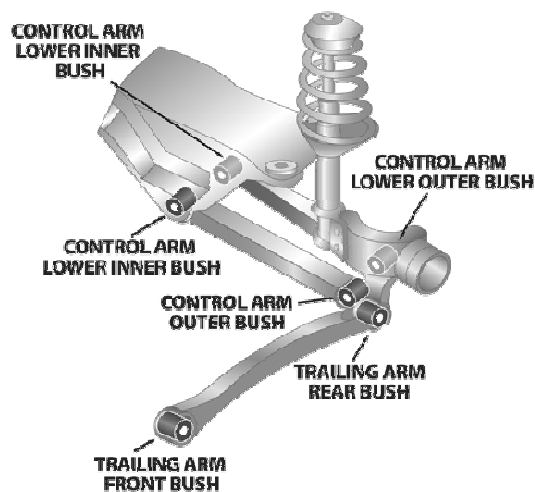
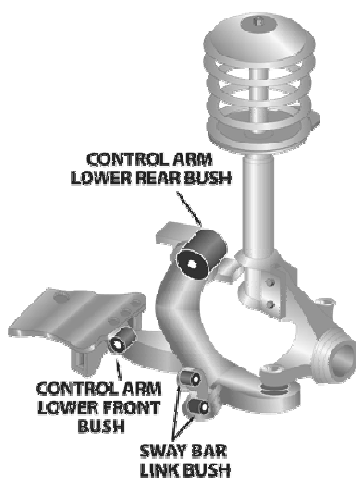

## NISSAN Maxima UA32 Series - 2/1995 - 11/1999

Página 1









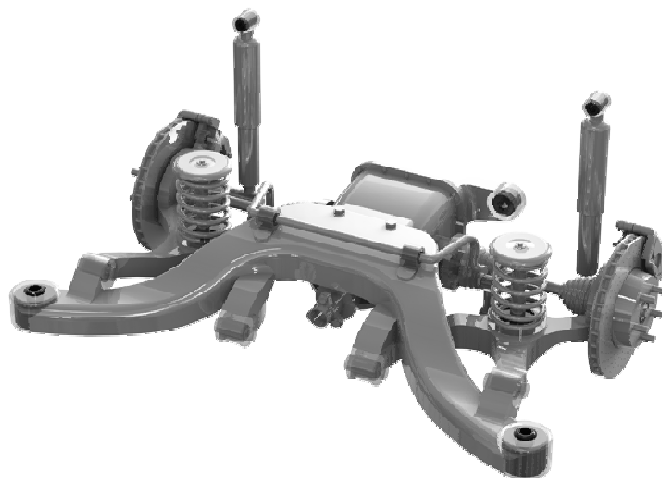
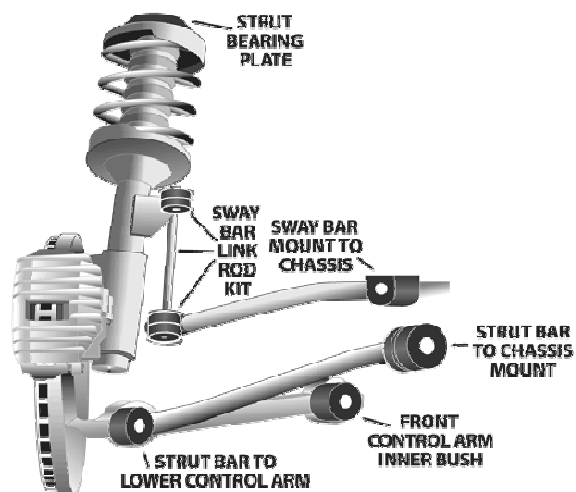

Aplicaci...	Descripción	Referencia	Kits por...	Contenido del Kit	
DEL.	Control Arm Lower-Front Bushing Tube = 18mm ID, 47.5mm long	<b>MPU-1217K</b>	1	Washers, Inner Tubes, Bushings	
DEL.	Control Arm Lower-Inner Rear Kit Standard setting	<b>MPU-1338K</b>	1	Bushings	
DEL.	Control Arm Lower-Inner Rear Kit 1 x Offset 1 x Standard bushing, to adjust caster settings	<b>MPU-1339K</b>	1	Bushings	
DEL.	Control Arm Lower-Inner Rear Kit 2 x Offset bushings, PS increased DS decrease caster	<b>MPU-1340K</b>	1	Bushings	



## NISSAN 180SX / 240SX S13 - 1984 - 1996

Página 1



Aplicaci...	Descripción	Referencia	Kits por...	Contenido del Kit	
DEL.	Control Arm Lower-Inner Bushing Stepped shell 34mm to 36mm outside diameter	<b>MPU-1009K</b>	1	Bushings, Inner Tubes, Outer Shells	
DEL.	Control Arm Lower-Inner Bushing Stepped shell, 38mm to 40mm outside diameter	<b>MPU-1483K</b>	1	Bushings, Inner Tubes, Outer Shells, Washers	
DEL.	Steering Rack & Pinion Mount Bush....Power Steering Replaces RH side OE#54444-61U00, & LH side OE#54445-35F00	<b>MPU-2825K</b>	1	Bushings	
DEL.	Strut Bar To Chassis Mount Kit Standard, 69.5mm long tube, Bracket width 40mm	<b>MPU-1202K</b>	1	Inner Tubes, Bushings	
DEL.	Strut Bar To Chassis Mount-Adjustable Bushing PS & DS Inc/Dec caster, 69.5 tube, Bracket width 40mm	<b>MPU-1202AK</b>	1	Inner Tubes, Bushings	
DEL.	Sway Bar Link Bushing Kit	<b>MPU-2092B-4K</b>	1	Bushings	
DEL.	Sway Bar Mount To Chassis Bushing Measure bar diameter 24,25,26,27mm available	<b>MPU-1636-__K</b>	1	Bushings	



## NISSAN 180SX / 240SX S13 - 1984 - 1996

Página 2 (Continúa)

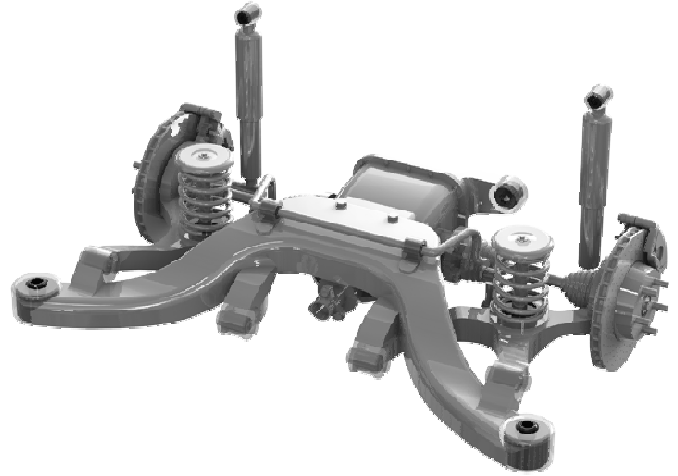
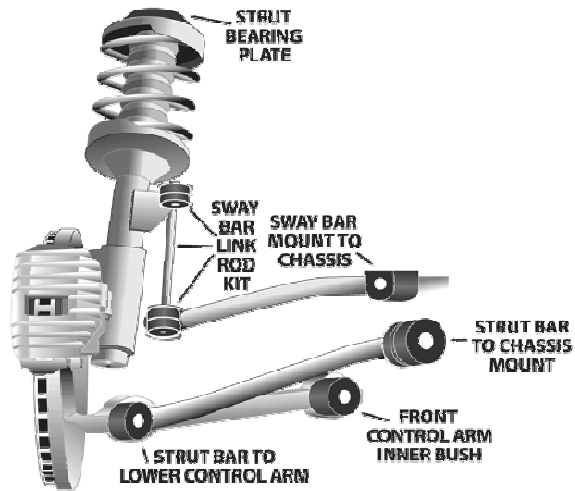

Aplicaci...	Descripción	Referencia	Kits por...	Contenido del Kit	
F & R	SuperPro Alignment Kit SPF1202AK x 1, SPF1869K x 2. See any notes listed against individual part numbers below.	<b>MPK-123K</b>	1	Inner Tubes, Bushings	
F & R	SuperPro Enhancement Kit SPF1009Kx1 Stepped shell 34mm to 36mm outside diameter, SPF1202Kx1, SPF1639Kx1, SPF1638Kx2. See any notes listed against...	<b>MPK-124K</b>	1	Outer Shells, Inner Tubes, Bushings	
F & R	SuperPro Enhancement Kit SPF1483Kx1 Stepped Shell 38mm to 40mm on the outside diameter, SPF1202Kx1, SPF1639Kx1, SPF1638Kx2. See any notes listed against...	<b>MPK-125K</b>	1	Outer Shells, Inner Tubes, Bushings	
TRAS.	Control Arm Lower-Inner Bushing	<b>MPU-1639K</b>	1	Bushings, Inner Tubes	
TRAS.	Control Arm Rear-LWR-Toe Adjusting.....Arm 2 wheel steering only	<b>MPU-1638K</b>	1	Inner Tubes, Bushings	
TRAS.	Control Arm Upper-Inner / Outer Kit 40mm crush tube	<b>MPU-1638K</b>	1	Inner Tubes, Bushings	



## NISSAN 180SX / 240SX S13 - 1984 - 1996

Página 3 (Continúa)

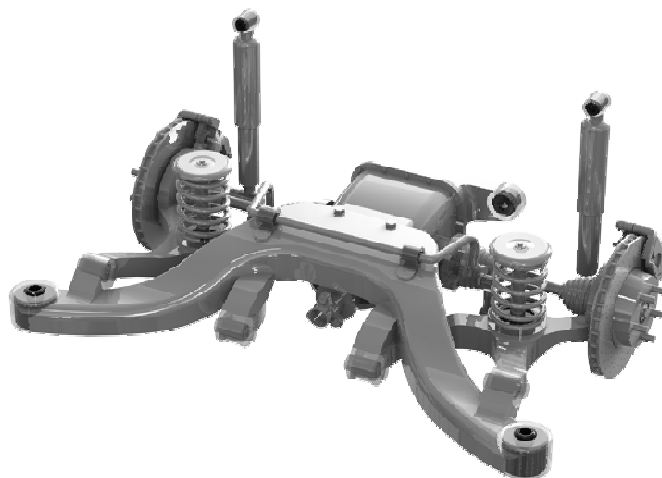
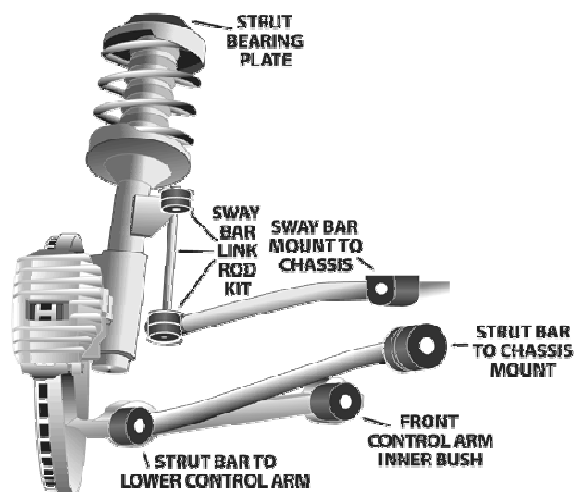





Aplicaci...	Descripción	Referencia	Kits por...	Contenido del Kit	
TRAS.	Control Arm Upper-Inner or Outer..... Eccentric Bushing Inner & outer camber adjustment, 40mm long offset tube	<b>MPU-1869K</b>	2	Inner Tubes, Bushings	
TRAS.	Cross-member Mount Bushing	<b>MPU-3774K</b>	1	Outer Shells, Inner Tubes, Bushings	
TRAS.	Cross-member Supplement Washers Large ring, 80mm outside diameter	<b>MPU-1799K</b>	0	Bushings	
TRAS.	Cross-member Supplement Washers Small ring, 69.5mm outside diameter	<b>MPU-1800K</b>	0	Bushings	
TRAS.	Crossmember Insert Enhancement Kit Supplement washers, outer cross member, top & bottom.	<b>MPU-2687K</b>	1	Bushings	
TRAS.	Diff to Cross-member to Chassis Kit	<b>MPU-3775K</b>	1	Outer Shells, Inner Tubes, Bushings, Inst Sheet	
TRAS.	Radius Arm Upper-Inner/Outer Bushing 40mm crush tube	<b>MPU-1638K</b>	1	Inner Tubes, Bushings	

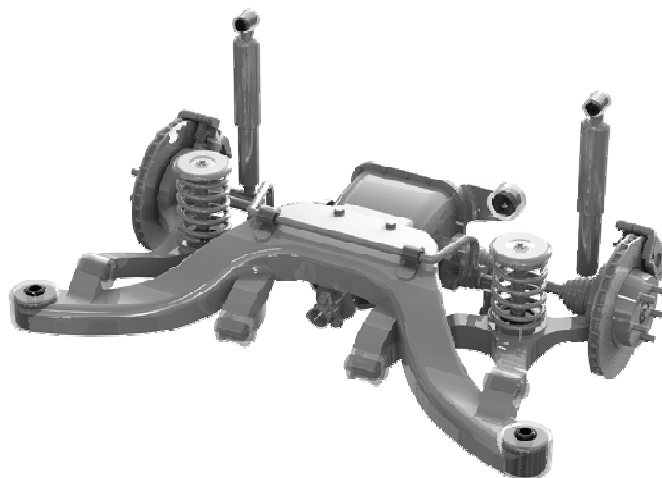
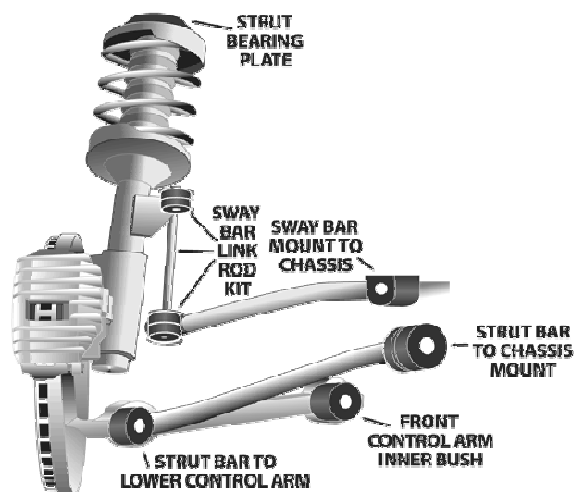

**NISSAN 180SX / 240SX S13 - 1984 - 1996**

Página 4 (Continúa)









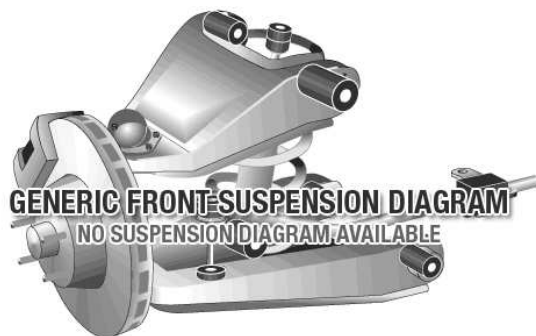
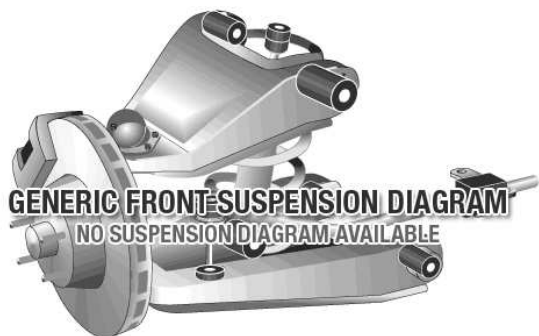

Aplicaci...	Descripción	Referencia	Kits por...	Contenido del Kit	
TRAS.	Sway Bar Link Bushing Kit	<b>MPU-2667K</b>	1	Bushings	
TRAS.	Sway Bar Mount To Chassis Bushing Measure bar diameter 15,16,18,20,22,23,24mm available	<b>MPU-1485-__K</b>	1	Bushings	



## NISSAN Silvia S13 - 1984 - 1994

Página 1









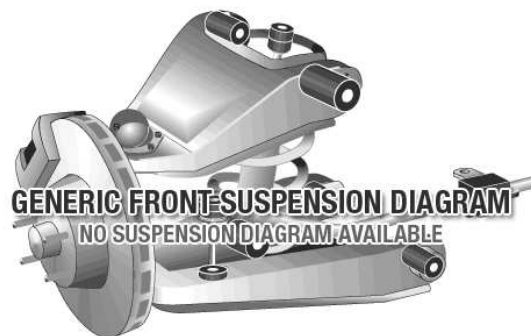
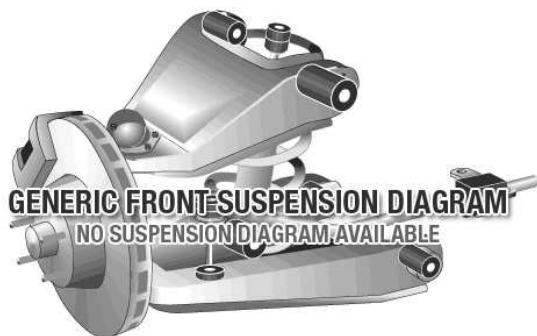

Aplicaci...	Descripción	Referencia	Kits por...	Contenido del Kit	
DEL.	Control Arm Lower-Inner Bushing Stepped shell 34mm to 36mm outside diameter	<b>MPU-1009K</b>	1	Bushings, Inner Tubes, Outer Shells	
DEL.	Control Arm Lower-Inner Bushing Stepped shell, 38mm to 40mm outside diameter	<b>MPU-1483K</b>	1	Bushings, Inner Tubes, Outer Shells, Washers	
DEL.	Steering Rack & Pinion Mount Bush....Power Steering Replaces RH side OE#54444-61U00, & LH side OE#54445-35F00	<b>MPU-2825K</b>	1	Bushings	
DEL.	Strut Bar To Chassis Mount Kit Standard, 69.5mm long tube, Bracket width 40mm	<b>MPU-1202K</b>	1	Inner Tubes, Bushings	
DEL.	Strut Bar To Chassis Mount-Adjustable Bushing PS & DS Inc/Dec caster, 69.5 tube, Bracket width 40mm	<b>MPU-1202AK</b>	1	Inner Tubes, Bushings	
DEL.	Sway Bar Mount To Chassis Bushing Measure bar diameter 24,25,26,27mm available	<b>MPU-1636-__K</b>	1	Bushings	
F & R	SuperPro Alignment Kit SPF1202AK x 1, SPF1869K x 2. See any notes listed against individual part numbers below.	<b>MPK-123K</b>	1	Inner Tubes, Bushings	



## NISSAN Silvia S13 - 1984 - 1994

Página 2 (Continúa)



Aplicaci...	Descripción	Referencia	Kits por...	Contenido del Kit	
F & R	SuperPro Enhancement Kit SPF1009x1 Stepped shell 34mm to 36mm outside diameter, SPF1202Kx1, SPF1639Kx1, SPF1638Kx2. See any notes listed against...	<b>MPK-124K</b>	1	Outer Shells, Inner Tubes, Bushings	
F & R	SuperPro Enhancement Kit SPF1483Kx1 Stepped shell 38mm to 40mm outside diameter, SPF1202Kx1, SPF1639Kx1, SPF1638Kx2. See any notes listed against...	<b>MPK-125K</b>	1	Outer Shells, Inner Tubes, Bushings	
TRAS.	Control Arm Lower-Inner Bushing 45mm crush tube	<b>MPU-1639K</b>	1	Bushings, Inner Tubes	
TRAS.	Control Arm Rear-LWR-Toe Adjusting.....Arm Front wheel steering only	<b>MPU-1638K</b>	1	Inner Tubes, Bushings	
TRAS.	Control Arm Upper-Inner / Outer Kit 40mm crush tube	<b>MPU-1638K</b>	2	Inner Tubes, Bushings	
TRAS.	Control Arm Upper-Inner or Outer..... Eccentric Bushing Inner & outer camber adjustment,40mm long offset tube	<b>MPU-1869K</b>	2	Inner Tubes, Bushings	









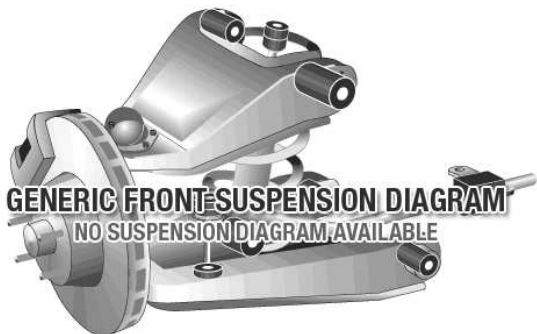

## NISSAN Silvia S13 - 1984 - 1994

Página 3 (Continúa)



Aplicaci...	Descripción	Referencia	Kits por...	Contenido del Kit	
TRAS.	Cross-member Supplement Washers Large ring, 80mm outside diameter	<b>MPU-1799K</b>	0	Bushings	
TRAS.	Cross-member Supplement Washers Small ring, 69.5mm outside diameter	<b>MPU-1800K</b>	0	Bushings	
TRAS.	Crossmember Insert Enhancement Kit Supplement washers, outer cross member, top & bottom.	<b>MPU-2687K</b>	1	Bushings	
TRAS.	Radius Arm Upper-Inner/Outer Bushing 40mm crush tube	<b>MPU-1638K</b>	1	Inner Tubes, Bushings	
TRAS.	Sway Bar Link Bushing Kit	<b>MPU-2667K</b>	1	Bushings	
TRAS.	Sway Bar Mount To Chassis Bushing Measure bar diameter 15,16,18,20,22,23,24mm available	<b>MPU-1485-__K</b>	1	Bushings	



**NISSAN Navara D21/ Pick Up 2WD & 4WD - 1/1986 - 3/1997**

Página 1

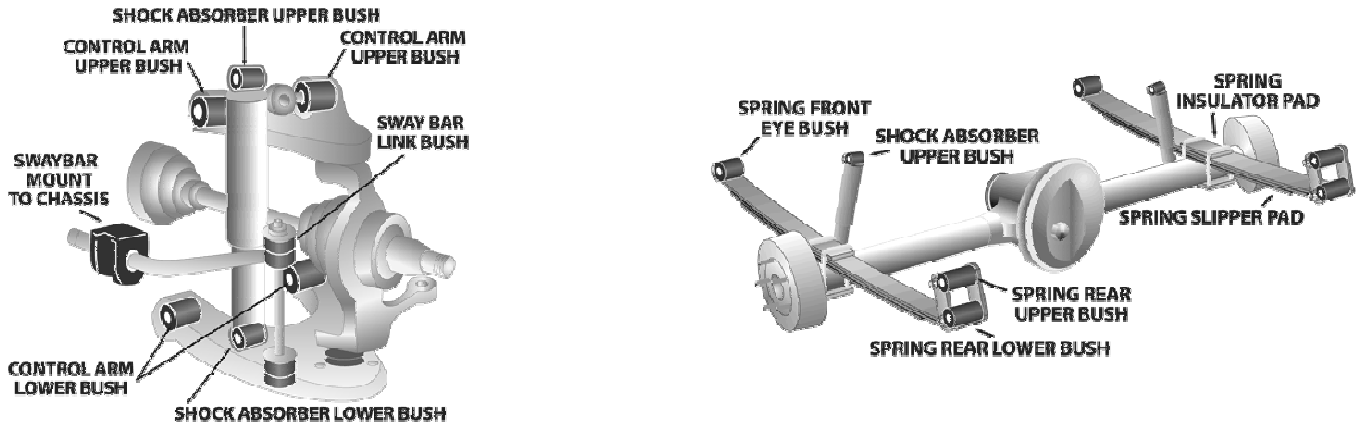

Aplicaci...	Descripción	Referencia	Kits por...	Contenido del Kit	
DEL.	Bump Stop - Upper	<b>MPU-0658K</b>	1	Bushings	
DEL.	Control Arm Lower Rear Bushing 4WD	<b>MPU-0148K</b>	1	Inner Tubes, Bushings	
DEL.	Control Arm Lower-Front Bushing 2WD & 4WD; Must remove OE outer shell for fitment.	<b>MPU-2151K</b>	1	Inner Tubes, Bushings	
DEL.	Control Arm Upper-Inner Kit Re-use original shell, "D21 Only"	<b>MPU-0879K</b>	1	Inner Tubes, Bushings	
DEL.	Idler Arm Bushing 2WD & 4WD straight style bush, normally D21 model	<b>MPU-1288K</b>	1	Bushings	
DEL.	Shock Absorber Upper Bushing	<b>MPU-0094K</b>	2	Bushings	
DEL.	Strut Bar To Chassis Mount Kit 2WD	<b>MPU-0881K</b>	1	Inner Tubes, Bushings	



**NISSAN Navara D21/ Pick Up 2WD & 4WD - 1/1986 - 3/1997**

Página 2 (Continúa)

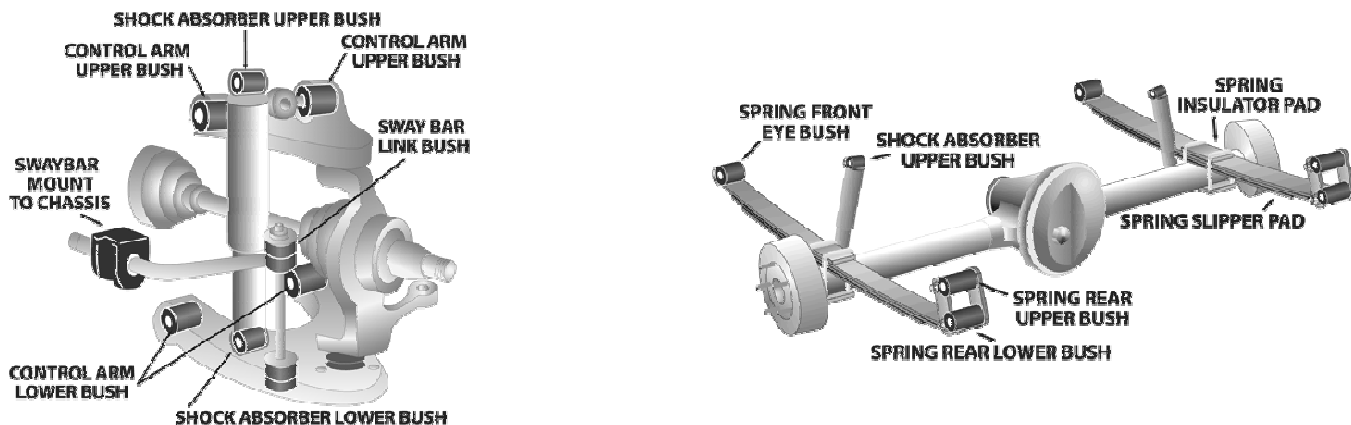

Aplicaci...	Descripción	Referencia	Kits por...	Contenido del Kit	
DEL.	Sway Bar Link Bushing Kit	<b>MPU-2092BK</b>	1	Bushings	
DEL.	Sway Bar Mount To Chassis Bushing 4WD Measure bar diameter 20, 22, 24mm available	<b>MPU-0900-__K</b>	1	Bushings	
DEL.	Sway Bar Mount To Chassis Bushing 2WD measure bar diameter 19,23,25mm available	<b>MPU-0965-__K</b>	1	Bushings	
TRAS.	Leaf Spring Bushing All 4WD Kit contains 1 x SPF1163K & 1 X SPF0203K	<b>MPK-136K</b>	1	Inner Tubes, Bushings	
TRAS.	Leaf Spring Bushing All 2WD Kit contains SPF0055Kx1 & SPF0203Kx1	<b>MPK-074K</b>	1	Bushings	
TRAS.	Shock Absorber Upper / Lower Bushing	<b>MPU-2178-16K</b>	2	Bushings	
TRAS.	Spring Front Eye Bushing 2WD	<b>MPU-0055K</b>	1	Bushings	



NISSAN Navara D21/ Pick Up 2WD & 4WD - 1/1986 - 3/1997

Página 3 (Continúa)

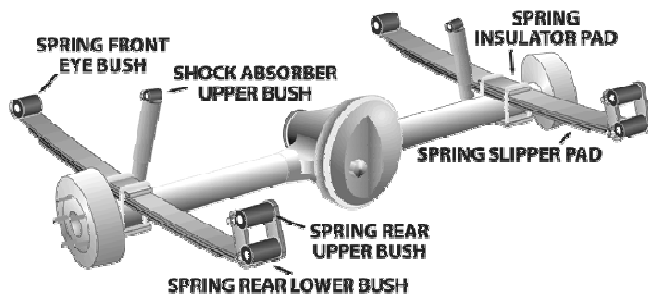
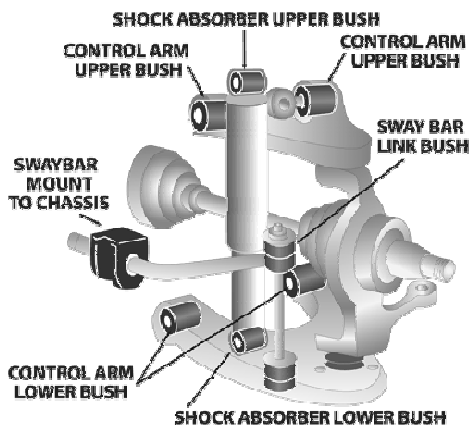

Aplicaci...	Descripción	Referencia	Kits por...	Contenido del Kit	
TRAS.	Spring Front Eye Bushing 4WD	MPU-1163K	1	Inner Tubes, Bushings	
TRAS.	Spring Rear Bushing All Excluding V6 "2WD & 4WD"	MPU-0203K	1	Bushings	
TRAS.	Spring Rear Bushing All V6 model 1992 onwards	MPU-0995K	1	Inner Tubes, Bushings	



## NISSAN Patrol Y60 Series GQ LWB & SWB - Safari - 2/1988 - ...

Página 1

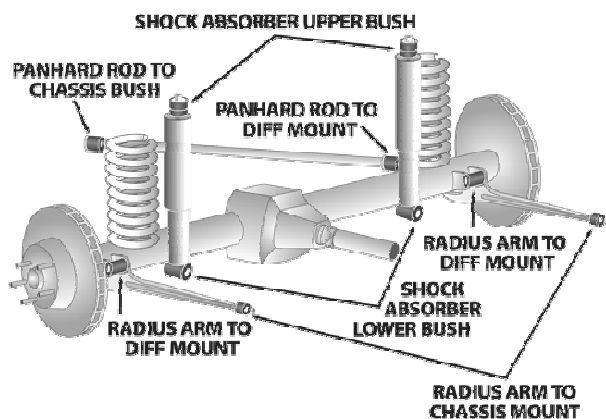
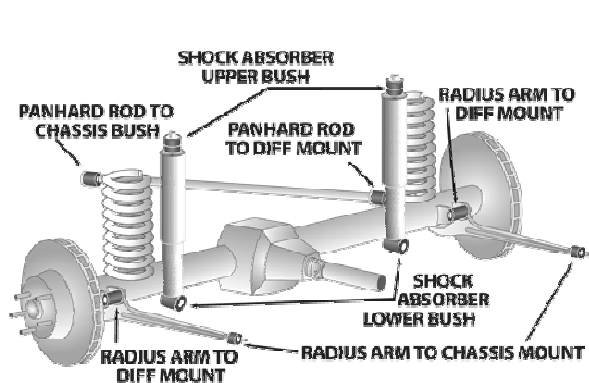

Aplicaci...	Descripción	Referencia	Kits por...	Contenido del Kit	
DEL.	Coil Spring Spacer Bushing Raises vehicle approximately 15mm	<b>MPU-1734K</b>	2	Bushings	
DEL.	Coil Spring Spacer Bushing Raises vehicle approximately 30mm	<b>MPU-2364-30K</b>	2	Bushings	
DEL.	Panhard Rod Bushing	<b>MPU-0398K</b>	1	Inner Tubes, Bushings	
DEL.	Radius Arm To - Chassis Kit	<b>MPU-0397K</b>	1	Bushings	
DEL.	Radius Arm To - Chassis, Setback Kit Alignment correction kit	<b>MPU-3467K</b>	1	Inst Sheet, Bushings	
DEL.	Radius Arm To - Diff Mount - Eccentric Kit Offset centre hole to increase caster settings	<b>MPU-1721K</b>	1	Inst Sheet, Outer Shells, Inner Tubes, Bushings	
DEL.	Radius Arm To - Diff Mount - Eccentric Kit Extra offset "High Lift Vehicles" To increase caster settings	<b>MPU-1721XK</b>	1	Inst Sheet, Outer Shells, Inner Tubes, Bushings	



## NISSAN Patrol Y60 Series GQ LWB & SWB - Safari - 2/1988 -...

Página 2 (Continúa)

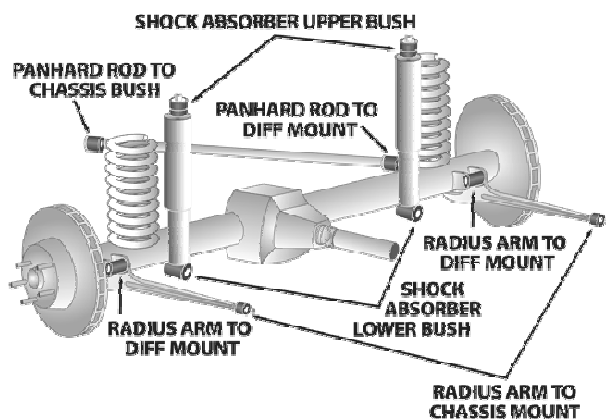
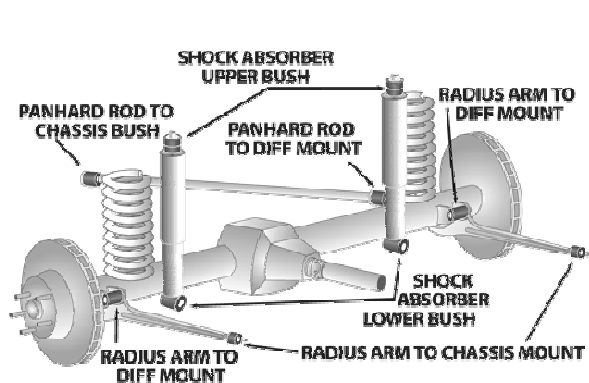







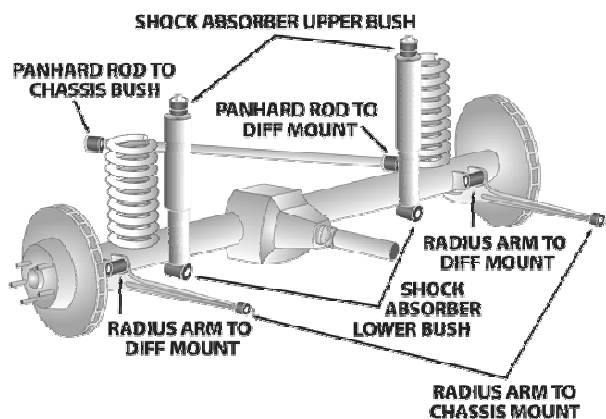
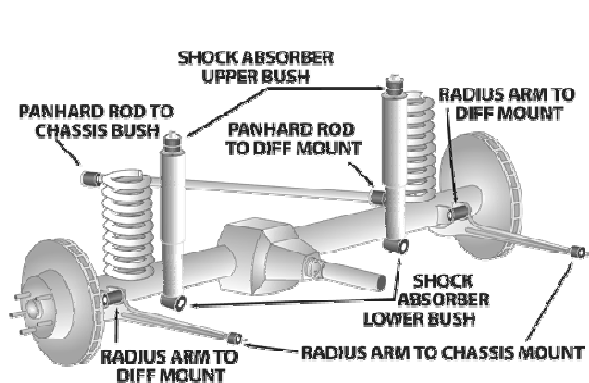

Aplicaci...	Descripción	Referencia	Kits por...	Contenido del Kit	
DEL.	Radius Arm To - Diff Mount Bushing	<b>MPU-0396K</b>	1	Inner Tubes, Bushings	 SPF0396K
DEL.	Shock Absorber Upper / Lower Bushing	<b>MPU-0740K</b>	2	Bushings	 0740K
DEL.	Sway Bar Link Bushing Kit	<b>MPU-2092BK</b>	1	Bushings	 SPF2092BK
DEL.	Sway Bar Mount To Axle Bushing Measure bar diameter 15,18,20,22,24mm available	<b>MPU-0626-__K</b>	1	Bushings	
F & R	Radius Arms & Panhard Rods Bush Kit Up to 1989	<b>MPK-059K</b>	1		
F & R	Radius Arms & Panhard Rods Bush Kit 1989 on	<b>MPK-060K</b>	1		
TRAS.	Coil Spring Spacer Bushing Raises vehicle approximately 15mm	<b>MPU-1736-15K</b>	2	Bushings	 1736-15K



## NISSAN Patrol Y60 Series GQ LWB & SWB - Safari - 2/1988 - ...

Página 3 (Continúa)









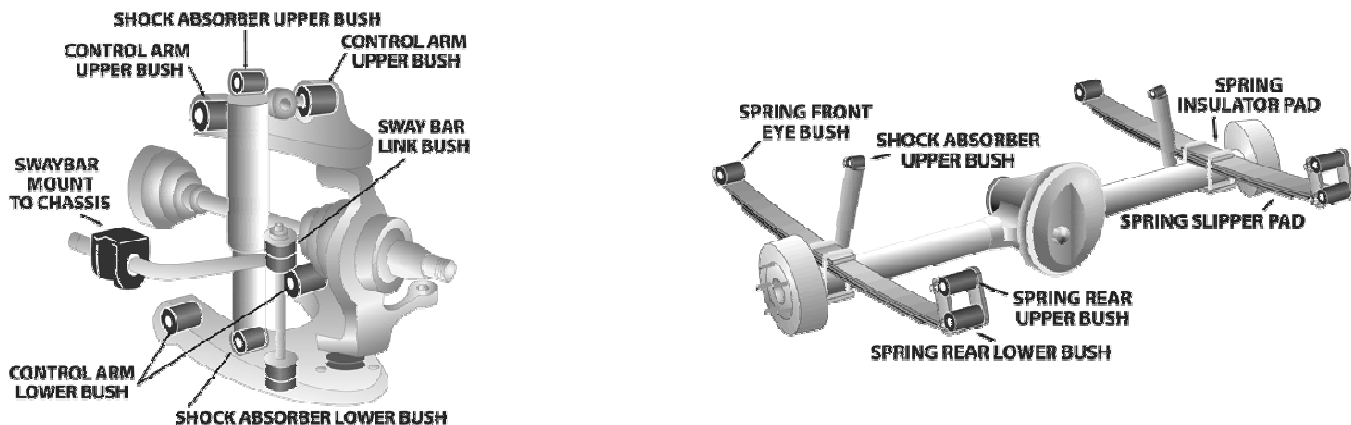

Aplicaci...	Descripción	Referencia	Kits por...	Contenido del Kit	
TRAS.	Coil Spring Spacer Bushing Raises vehicle approximately 30mm	<b>MPU-1736-30K</b>	2	Bushings	
TRAS.	Panhard Rod Bushing 1989 model on	<b>MPU-0398K</b>	1	Inner Tubes, Bushings	
TRAS.	Panhard Rod Bushing Up to 1989 model	<b>MPU-0444K</b>	1	Bushings, Inner Tubes	
TRAS.	Sway Bar Link Bushing Kit	<b>MPU-2092B-4K</b>	1	Bushings	
TRAS.	Sway Bar Mount To Axle Bushing Measure bar diameter 15,18,20,22,24mm available	<b>MPU-0627-__K</b>	1	Bushings	
TRAS.	Trailing Arm Lower Bushing All	<b>MPU-0399K</b>	2	Inner Tubes, Bushings	
TRAS.	Trailing Arm Upper Bushing All	<b>MPU-0399K</b>	2	Inner Tubes, Bushings	



## NISSAN Navara D22 / Frontier 2WD & 4WD Series I & II -...

Página 1



Aplicaci...	Descripción	Referencia	Kits por...	Contenido del Kit	
DEL.	Control Arm Lower-Inner Front Kit 4WD	<b>MPU-2150K</b>	1	Bushings, Inner Tubes	
DEL.	Control Arm Lower-Inner Rear Kit 4/1997 to 10/2001 4WD Remove original shell for fitment	<b>MPU-2151K</b>	1	Inner Tubes, Bushings	
DEL.	Control Arm Lower-Inner Rear Kit 11/2001 to Current 4WD, Remove OE shell for fitment	<b>MPU-2341K</b>	1	Inner Tubes, Bushings	
DEL.	Control Arm Upper-Inner Kit Must Re-use original shell	<b>MPU-2021K</b>	1	Inner Tubes, Bushings	
DEL.	Sway Bar Link Bushing Kit	<b>MPU-2092K</b>	1	Bushings	
DEL.	Sway Bar Mount To Chassis Bushing Please measure bar diameter	<b>MPU-1484-__K</b>	1	Bushings	
TRAS.	Leaf Spring Bushing All 4WD Kit contains 1 x SPF1163K & 1 X SPF0203K	<b>MPK-136K</b>	1	Inner Tubes, Bushings	





## NISSAN Navara D22 / Frontier 2WD & 4WD Series I & II -...

Página 2 (Continúa)

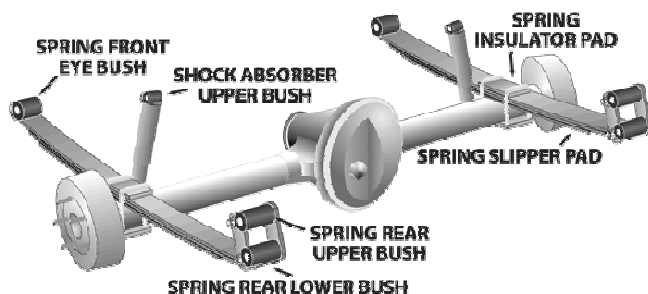
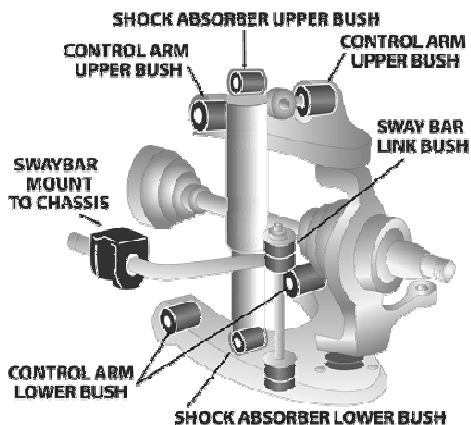



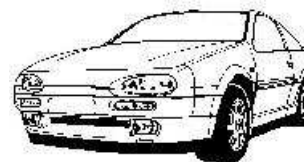



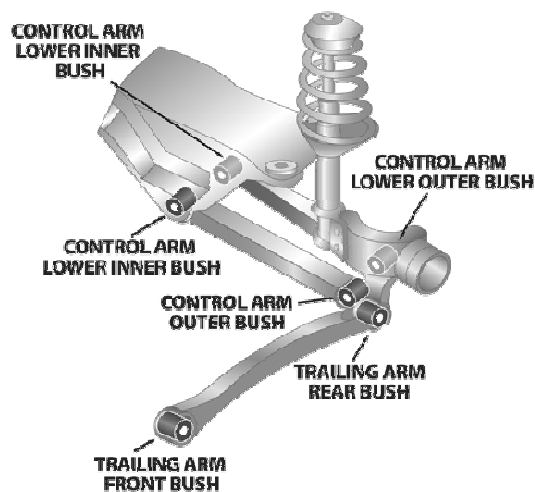
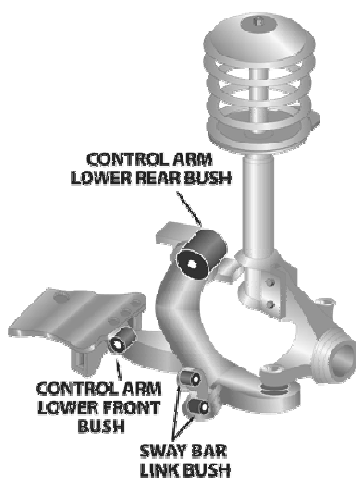

Aplicaci...	Descripción	Referencia	Kits por...	Contenido del Kit	
TRAS.	Leaf Spring Bushing All 2WD Kit contains SPF0055Kx1 & SPF0203Kx1	<b>MPK-074K</b>	1	Bushings	
TRAS.	Spring Front Eye Bushing 2WD	<b>MPU-0055K</b>	1	Bushings	
TRAS.	Spring Front Eye Bushing 4WD	<b>MPU-1163K</b>	1	Inner Tubes, Bushings	
TRAS.	Spring Rear Bushing All	<b>MPU-0203K</b>	1	Bushings	



NISSAN NX-R Coupe - 10/1991 - 5/1995

Página 1





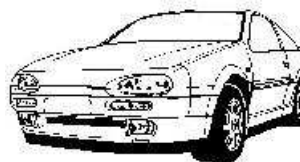

Aplicaci...	Descripción	Referencia	Kits por...	Contenido del Kit	
DEL.	Control Arm Lower Rear Bushing Standard setting	MPU-1338K	1	Bushings	
DEL.	Control Arm Lower Rear Bushing 1 x Offset 1 x Standard bushing, to adjust caster settings	MPU-1339K	1	Bushings	
DEL.	Control Arm Lower Rear Bushing 2 x Offset bushings, Increase positive caster both sides	MPU-1340AK	1	Bushings	
DEL.	Control Arm Lower Rear Bushing 2 x Offset bushings, PS increased DS decrease caster	MPU-1340K	1	Bushings	
DEL.	Control Arm Lower-Front Bushing	MPU-1341K	1	Washers, Inner Tubes, Bushings	
DEL.	Sway Bar Mount Bushing Measure bar diameter 16,22,24,25,26,27,28mm available	MPU-1135-__K	1	Bushings	
TRAS.	Sway Bar Mount To Chassis Bushing Measure bar diameter 12,13,14,16mm available	MPU-1192-__K	1	Bushings	

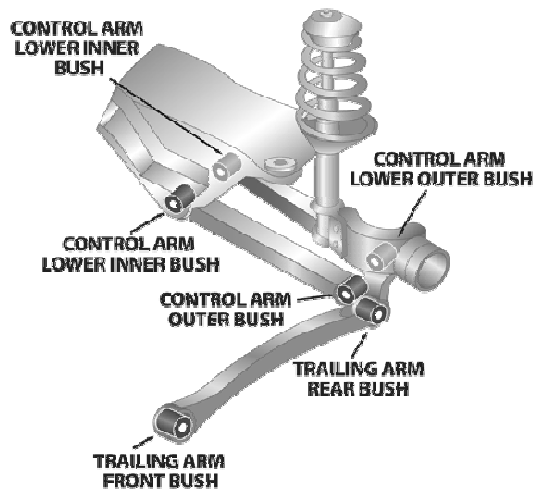
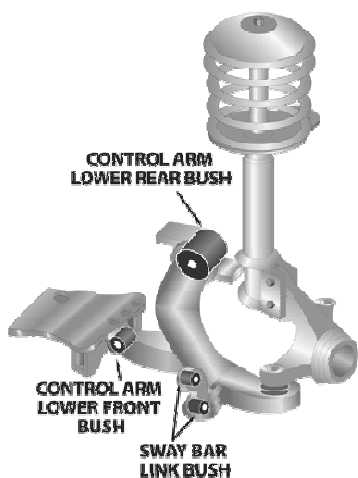

**NISSAN NX-R Coupe - 10/1991 - 5/1995**

Página 2 (Continúa)









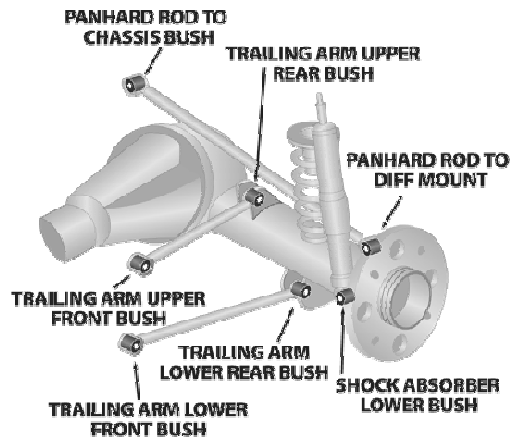
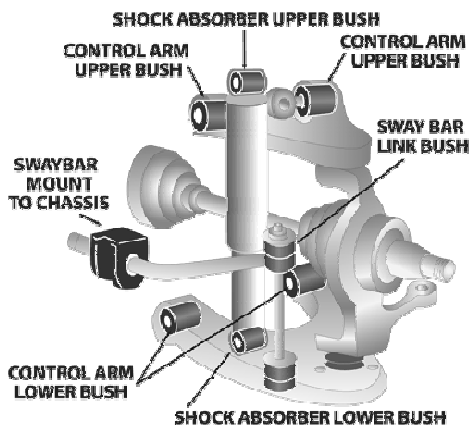

Aplicaci...	Descripción	Referencia	Kits por...	Contenido del Kit	
TRAS.	Trailing Arm - Front Bushing	<b>MPU-0835-4K</b>	1	Inner Tubes, Bushings	
TRAS.	Trailing Arm - Rear Bushing	<b>MPU-0691-2K</b>	1	Inner Tubes, Bushings	



**NISSAN Terrano II / Mistral R20 Series - 3/1997 - 6/2000**

Página 1









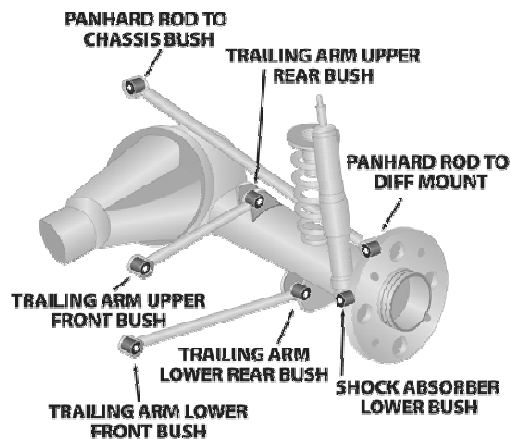
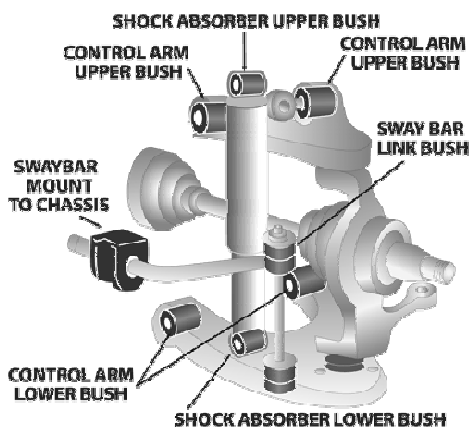

Aplicaci...	Descripción	Referencia	Kits por...	Contenido del Kit	
DEL.	Control Arm Lower-Inner Rear Kit Must remove OE outer shell for fitment.	<b>MPU-2151K</b>	1	Inner Tubes, Bushings	
DEL.	Control Arm Upper-Inner Kit Re-use original shell	<b>MPU-0879K</b>	1	Inner Tubes, Bushings	
DEL.	Idler Arm Bushing	<b>MPU-1288K</b>	1	Bushings	
DEL.	Strut Bar To Chassis Mount Kit	<b>MPU-0148K</b>	1	Inner Tubes, Bushings	
DEL.	Sway Bar Link To Chassis Bushing	<b>MPU-2092B-4K</b>	1	Bushings	
DEL.	Sway Bar Mount Bushing Please measure bar diameter	<b>MPU-1484-__K</b>	1	Bushings	
TRAS.	Panhard Rod Bushing	<b>MPU-1248K</b>	1	Inner Tubes, Bushings	



## NISSAN Terrano II / Mistral R20 Series - 3/1997 - 6/2000

Página 2 (Continúa)









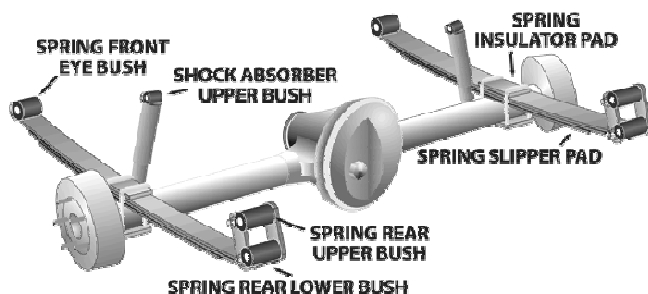
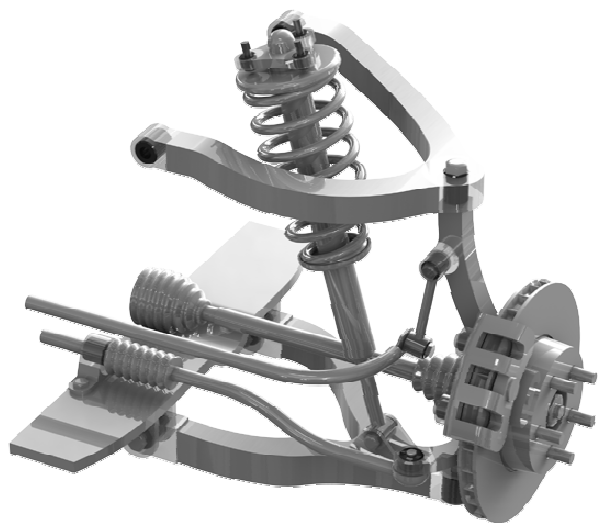

Aplicaci...	Descripción	Referencia	Kits por...	Contenido del Kit	
TRAS.	Sway Bar Link Bushing Kit	MPU-2092BK	1	Bushings	 SPF2092BK
TRAS.	Sway Bar Mount To Chassis Bushing	MPU-2257-__K	1	Bushings	
TRAS.	Trailing Arm Lower Bushing All	MPU-1247K	1	Inner Tubes, Bushings	 1 2 4 7 K
TRAS.	Trailing Arm Lower Bushing All	MPU-0399K	2	Inner Tubes, Bushings	 SPF0399K
TRAS.	Trailing Arm Upper Bushing All	MPU-1247K	1	Inner Tubes, Bushings	 1 2 4 7 K
TRAS.	Trailing Arm Upper Bushing All	MPU-0399K	2	Inner Tubes, Bushings	 SPF0399K



## NISSAN Navara D40 / Frontier 4WD - 2006 - On

Página 1









Aplicaci...	Descripción	Referencia	Kits por...	Contenido del Kit	
DEL.	Control Arm Lower-Inner Bushing Standard replacement.	<b>MPU-3023K</b>	1	Outer Shells, Inner Tubes, Bushings	
DEL.	Control Arm Lower-Inner Eccentric Kit 4 x Bushings with offset hole.	<b>MPU-3024K</b>	1	Outer Shells, Inner Tubes, Bushings	
DEL.	Control Arm Lower-Inner Eccentric Kit 4 x offset bushings & 4 x offset tubes, for use where max adjustment is needed	<b>MPU-3024XK</b>	1	Outer Shells, Inner Tubes, Bushings	
DEL.	Control Arm Upper-Inner Eccentric Kit Offset tubes to aid in camber adjustment in raised vehicles.	<b>MPU-3022XK</b>	1	Inst Sheet, Outer Shells, Inner Tubes, Bushings	
DEL.	Control Arm Upper-Inner Kit Standard replacement.	<b>MPU-3022K</b>	1	Inst Sheet, Outer Shells, Inner Tubes, Bushings	
DEL.	Spring Seat & Upper Shock Mount Kit Raises vehicle approx 10-15mm	<b>MPU-3026K</b>	1	Bushings	
DEL.	Steering Rack & Pinion Mount Bushing Replaces original hyme joint style bushings Suits Spanish built models only	<b>MPU-3028K</b>	1	Inner Tubes, Bushings	

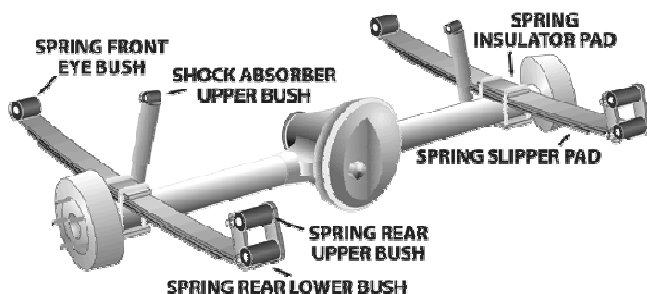
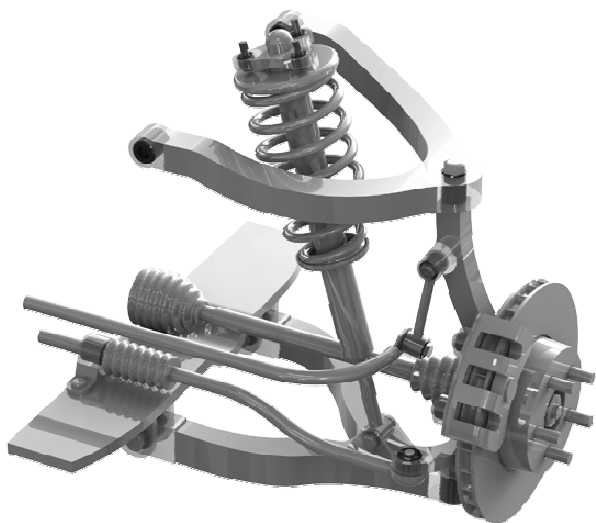

## NISSAN Navara D40 / Frontier 4WD - 2006 - On

Página 2 (Continúa)





Aplicaci...	Descripción	Referencia	Kits por...	Contenido del Kit	
DEL.	Sway Bar Mount Bushing Measure sway bar diameter, 33 & 34.3mm available	<b>MPU-3025-__K</b>	1	Bushings	 SPF3025K
TRAS.	Complete Rear Kit SPF2768K X 1, SPF2766K X 1, SPF2767K X 1	<b>MPK-141K</b>	1		
TRAS.	Spring Front Eye Bushing See special instruction sheet included in kit at fitment stage.	<b>MPU-2766K</b>	1	Inner Tubes, Bushings	 SPF2766K
TRAS.	Spring Rear Eye Bushing	<b>MPU-2767K</b>	1	Bushings	 SPF2767K
TRAS.	Spring Shackle Upper Bushing Bushing located in chassis	<b>MPU-2768K</b>	1	Bushings	

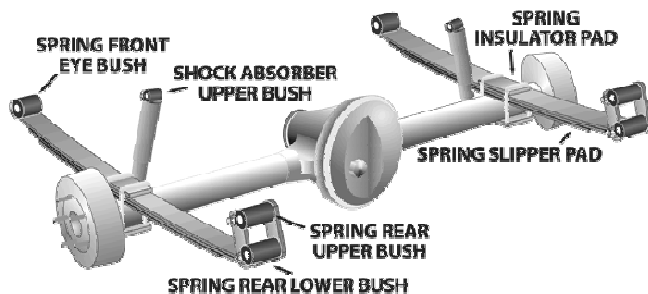
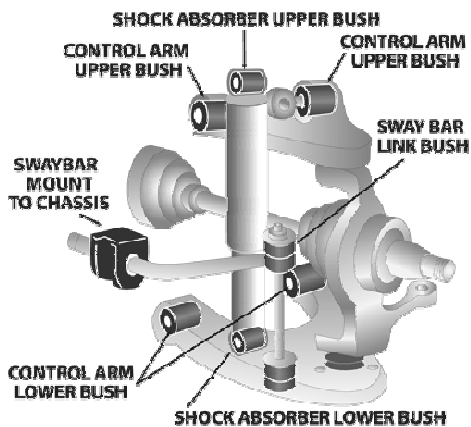

## NISSAN Caball Light Truck -

Página 1



Aplicaci...	Descripción	Referencia	Kits por...	Contenido del Kit	
TRAS.	Spring Shackle Rear-Upper&Lower Kit Bush 32mm outside diameter, 20mm inside diameter & 32mm body length	<b>MPU-0229K</b>	1	Bushings	







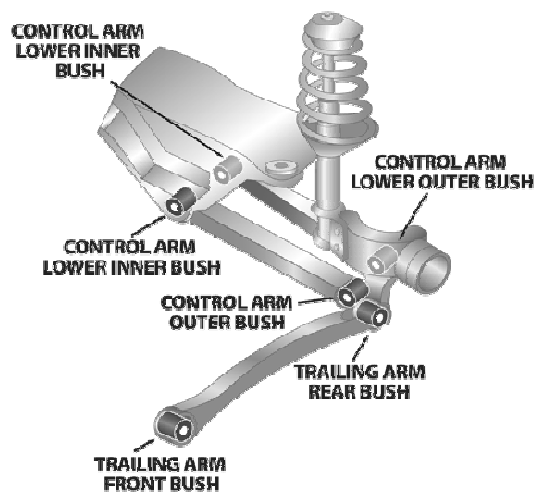
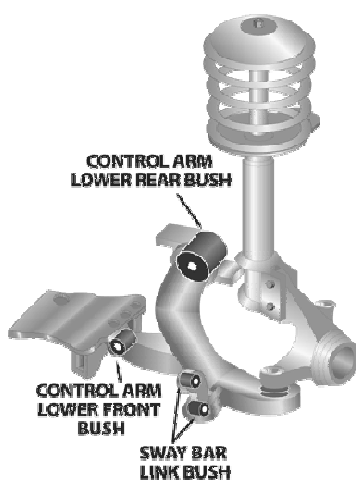

## NISSAN X-Trail T31 (Mk 2) 2WD / 4WD - 2007- On

Página 1







Aplicaci...	Descripción	Referencia	Kits por...	Contenido del Kit	
DEL.	Control Arm Lower-Inner Rear Eccentric Replaces Bushing in original arm #54500JG000 & 54501JG000 / 1x Offset bush & 1x Standard...	<b>MPU-3453K</b>	1	Bushings, Outer Shells, Inner Tubes, Inst Sheet	
DEL.	Control Arm Lower-Inner Rear Eccentric Replaces Bushing in original arm #54500JG000 & 54501JG000 / 2x Offset bushings.	<b>MPU-3454K</b>	1	Inst Sheet, Outer Shells, Inner Tubes, Bushings	
DEL.	Control Arm Lower-Inner Rear Kit Replaces Bushing in original arm #54500JG000 & 54501JG000	<b>MPU-3452K</b>	1	Inst Sheet, Outer Shells, Inner Tubes, Bushings	
TRAS.	Lateral Arm Rear Inner Bushing	<b>MPU-3929K</b>	1	Inner Tubes, Bushings	

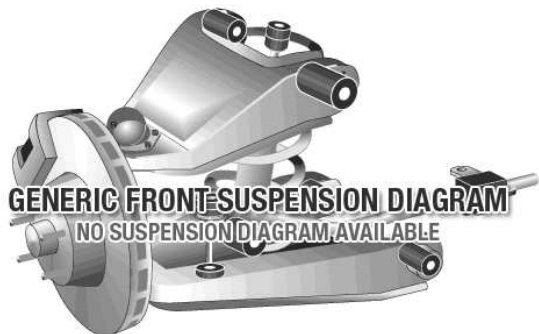

**NISSAN X-Trail T30 (Mk 1) 2WD / 4WD - 2001 - 2007**

Página 1







Aplicaci...	Descripción	Referencia	Kits por...	Contenido del Kit	
DEL.	Sway Bar Mount To Chassis Bushing Measure bar diameter 25mm available.	<b>MPU-3608-__K</b>	1	Bushings	
TRAS.	Sway Bar Mount To Chassis Bushing Please measure bar diameter	<b>MPU-3609-__K</b>	1	Bushings	

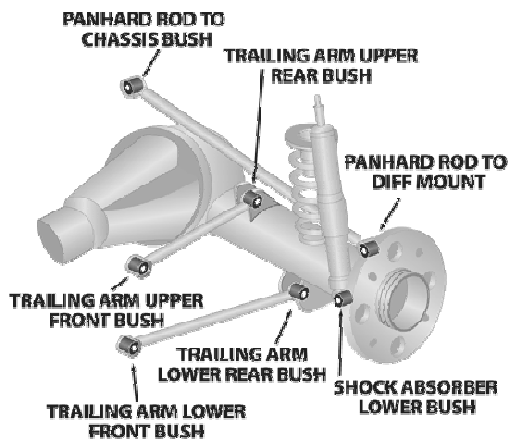
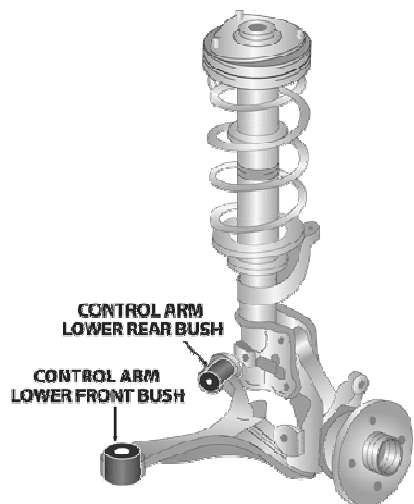

**NISSAN Murano Z50 Series Wagon - 8/2005 - 2009**

Página 1





Aplicaci...	Descripción	Referencia	Kits por...	Contenido del Kit	
DEL.	Control Arm Lower-Inner Eccentric Kit 1 x Standard & 1 x Offset bushing, Remove OE shell for fitment.	<b>MPU-3411K</b>	1	Bushings, Outer Shells, Inner Tubes, Washers, Inst Sheet	
DEL.	Control Arm Lower-Inner Eccentric Kit 2 x Offset bushings, Remove OE shell for fitment.	<b>MPU-3412K</b>	1	Inst Sheet, Washers, Outer Shells, Inner Tubes, Bushings	
DEL.	Control Arm Lower-Inner Front & Rear Remove OE shell for fitment.	<b>MPU-3410K</b>	1	Inst Sheet, Washers, Outer Shells, Inner Tubes, Bushings	

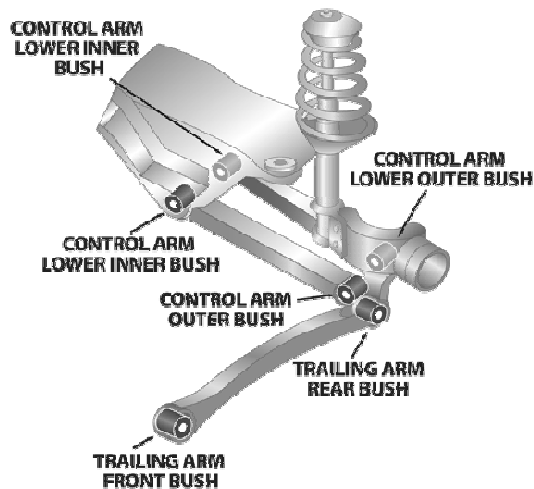
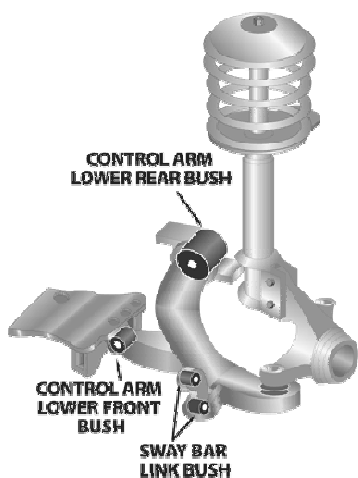

**NISSAN Tida C11 - 2/2006 - 2/2010**

Página 1









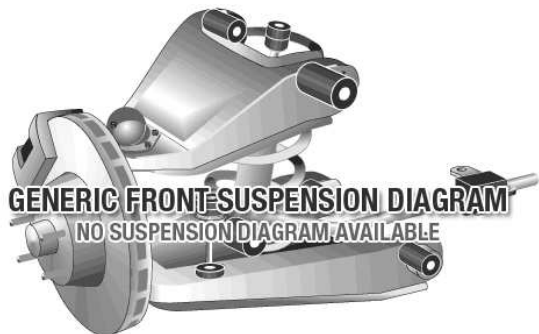

Aplicaci...	Descripción	Referencia	Kits por...	Contenido del Kit	
DEL.	Control Arm Lower-Inner Rear Kit Standard replacement	<b>MPU-3472K</b>	1	Bushings, Outer Shells, Inner Tubes, Inst Sheet	



## NISSAN 370Z Z34 (Coupe & Roadster) - 2009 - On

Página 1



Aplicaci...	Descripción	Referencia	Kits por...	Contenido del Kit	
DEL.	Control Arm Lower Rear Bushing Offset.	<b>MPU-3886K</b>	1	Bushings, Outer Shells, Inner Tubes	
DEL.	Control Arm Lower-Front Bushing	<b>MPU-3885K</b>	1	Bushings, Inner Tubes	
DEL.	Control Arm Upper-Inner Eccentric Kit Offset tubes for +/- camber adjustment, approx 0.5 degree change; Note vehicles with wide...	<b>MPU-3297K</b>	1	Inst Sheet, Inner Tubes, Bushings	
DEL.	Control Arm Upper-Inner Kit Standard replacement.	<b>MPU-3296K</b>	1	Inst Sheet, Inner Tubes, Bushings	
DEL.	Sway Bar Mount To Chassis Bushing AVAILABLE SIZES - 27,28mm	<b>MPU-3838-__K</b>	1	Bushings	
TRAS.	Control Arm Lower-Front Arm-Inner Kit Standard replacement.	<b>MPU-3316K</b>	1	Outer Shells, Inner Tubes, Bushings	
TRAS.	Control Arm Lower-Front Arm-Outer Kit Bushing mounted in hub.	<b>MPU-3318K</b>	1	Inst Sheet, Outer Shells, Inner Tubes, Bushings	



**NISSAN 370Z Z34 (Coupe & Roadster) - 2009 - On**

Página 2 (Continúa)

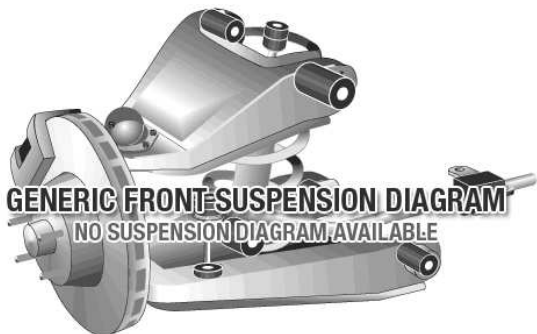



Aplicaci...	Descripción	Referencia	Kits por...	Contenido del Kit	
TRAS.	Control Arm Lower-Inner Front.....Eccentric Offset bushing +/- camber adjustment.	<b>MPU-3317K</b>	1	Inst Sheet, Outer Shells, Inner Tubes, Bushings	
TRAS.	Control Arm Lower-Inner Rear Eccentric Offset tube in kit for +/- toe adjustment.	<b>MPU-3321K</b>	1	Inst Sheet, Outer Shells, Inner Tubes, Bushings	
TRAS.	Control Arm Lower-Rear Arm-Inner Kit Standard replacement.	<b>MPU-3320K</b>	1	Outer Shells, Inner Tubes, Bushings	
TRAS.	Control Arm Lower-Rear Arm-Outer Kit Bushing mounted in hub.	<b>MPU-3322K</b>	1	Inst Sheet, Outer Shells, Inner Tubes, Bushings	
TRAS.	Control Arm Upper-Inner Eccentric Kit Note	<b>MPU-3313XK</b>	1	Inst Sheet, Inner Tubes, Bushings	
TRAS.	Control Arm Upper-Inner Kit Standard replacement.	<b>MPU-3313K</b>	1	Inst Sheet, Inner Tubes, Bushings	
TRAS.	Sway Bar Mount To Chassis Bushing AVAILABLE SIZES - 24,25mm	<b>MPU-3839-__K</b>	1	Bushings	



**NISSAN 370Z Z34 (Coupe & Roadster) - 2009 - On**

Página 3 (Continúa)









Aplicaci...	Descripción	Referencia	Kits por...	Contenido del Kit	
TRAS.	Trailing Arm - Front Bushing	<b>MPU-3314K</b>	1	Washers, Outer Shells, Inner Tubes, Bushings	
TRAS.	Trailing Arm - Rear Bushing Bushing mounted in hub.	<b>MPU-3315K</b>	1	Inst Sheet, Outer Shells, Inner Tubes, Bushings	

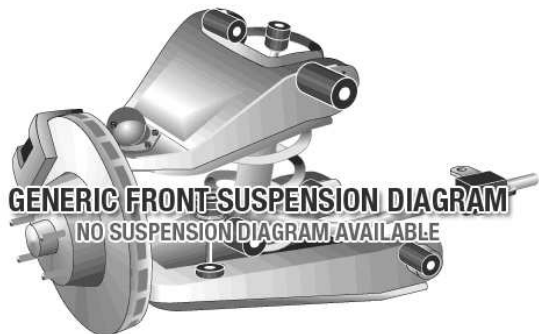

**NISSAN Elgrand E50 - 5/1997 - 5/2002**

Página 1



Aplicaci...	Descripción	Referencia	Kits por...	Contenido del Kit	
DEL.	Control Arm Lower-Front Bushing	<b>MPU-2036K</b>	1	Inner Tubes, Bushings	
DEL.	Control Arm Lower-Inner Rear Eccentric Single offset	<b>MPU-2038K</b>	1	Bushings	
DEL.	Control Arm Lower-Inner Rear Eccentric Double offset	<b>MPU-2039K</b>	1	Bushings	
DEL.	Control Arm Lower-Inner Rear Kit Standard Replacement	<b>MPU-2037K</b>	1	Bushings	









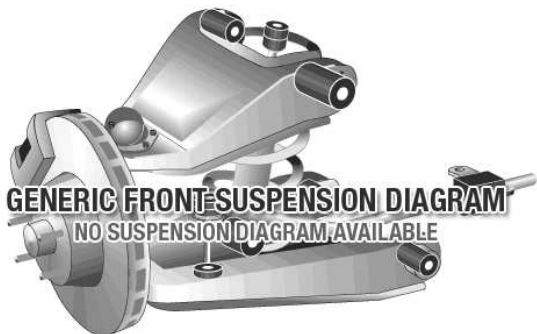



## NISSAN GT-R R35 - 2007 - Current

Página 1









Aplicaci...	Descripción	Referencia	Kits por...	Contenido del Kit	
DEL.	Control Arm Lower-Inner Front Kit	<b>MPU-3851K</b>	1	Inner Tubes, Bushings	
DEL.	Control Arm Lower-Inner Rear Eccentric Double Offset Kit.	<b>MPU-3852K</b>	1	Outer Shells, Inner Tubes, Bushings	
DEL.	Control Arm Upper-Inner Eccentric Kit Camber Adjustable includes spanner for adjustment.	<b>MPU-3850K</b>	1	Inner Tubes, Bushings, Bushings	
DEL.	Shock Absorber Lower Bushing Fits in control arm.	<b>MPU-3854K</b>	1	Outer Shells, Inner Tubes, Bushings	
DEL.	Steering Rack & Pinion Mount Bushing	<b>MPU-3857K</b>	1	Washers, Inner Tubes, Bushings	
DEL.	Sway Bar Mount To Chassis Bushing Measure bar diameter as 34,35,36mm available.	<b>MPU-3622-__K</b>	1	Bushings	
TRAS.	Control Arm Lower-Front Arm-Outer Kit Bushing mounted in hub.	<b>MPU-3318K</b>	1	Inst Sheet, Outer Shells, Inner Tubes, Bushings	

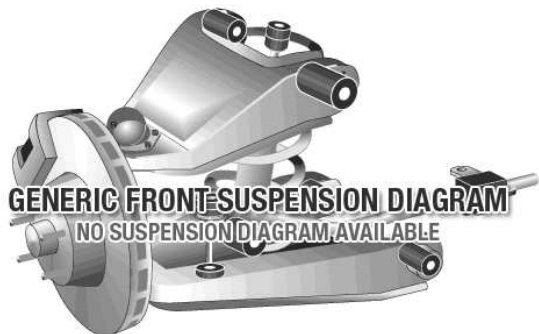

## NISSAN GT-R R35 - 2007 - Current

Página 2 (Continúa)







Aplicaci...	Descripción	Referencia	Kits por...	Contenido del Kit	
TRAS.	Control Arm Lower-Rear Arm-Outer Kit Bushing mounted in hub.	<b>MPU-3322K</b>	1	Inst Sheet, Outer Shells, Inner Tubes, Bushings	
TRAS.	Differential Mount Bushing 2 Kits per vehicle.	<b>MPU-3856K</b>	2	Outer Shells, Inner Tubes, Bushings	
TRAS.	Sway Bar Mount Bushing Measure sway bar diameter 14,18,20,21mm available.	<b>MPU-3621-__K</b>	1	Bushings	
TRAS.	Trailing Arm - Front Bushing	<b>MPU-3855K</b>	1	Inner Tubes, Bushings	
TRAS.	Trailing Arm - Rear Bushing Bushing mounted in hub.	<b>MPU-3315K</b>	1	Inst Sheet, Outer Shells, Inner Tubes, Bushings	

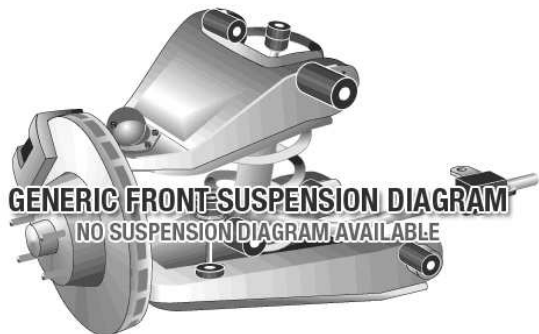

**NISSAN Patrol Y62 - 2010 - Current**

Página 1





Aplicaci...	Descripción	Referencia	Kits por...	Contenido del Kit	
DEL.	Sway Bar Mount Bushing Measure bar diameter	<b>MPU-4126-__K</b>	1	Bushings	
TRAS.	Sway Bar Mount Bushing Measure bar diameter	<b>MPU-4127-__K</b>	1	Bushings	

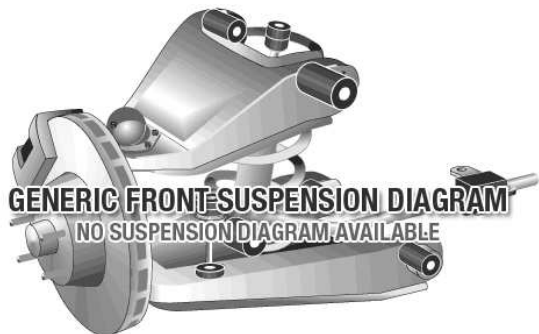

**NISSAN Juke F15 Series - 2010 - Current**

Página 1









Aplicaci...	Descripción	Referencia	Kits por...	Contenido del Kit	
DEL.	Control Arm Lower-Inner Front & Rear	<b>MPU-3962K</b>	1	Spacers, Inst Sheet, Outer Shells, Inner Tubes, Bushings	

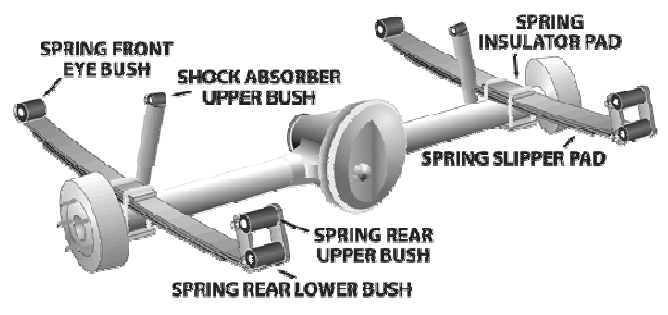
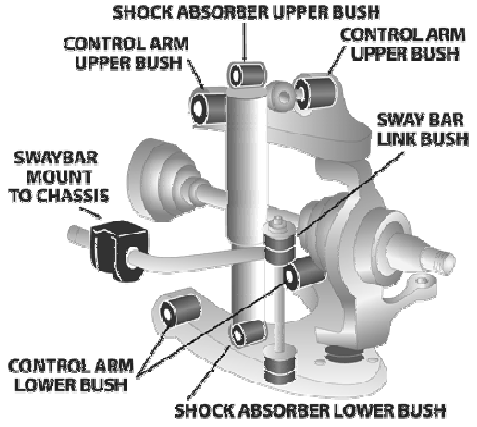

ASIA Rocksta Jeep - 1/1993 - 2000

Página 1









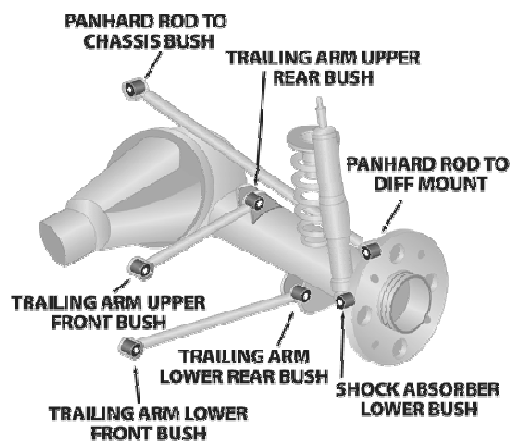
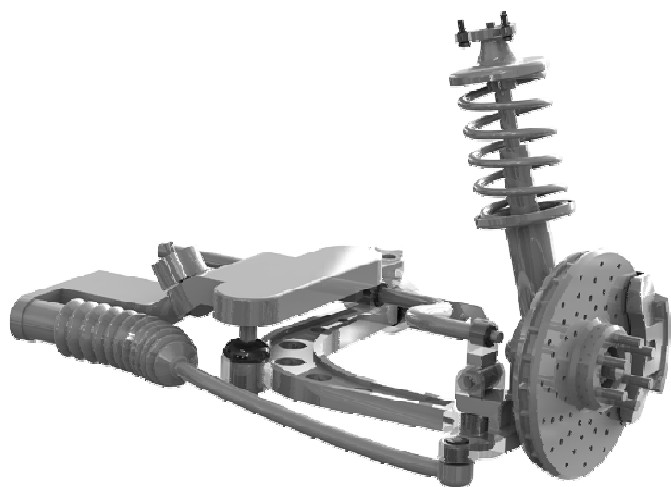

Aplicaci...	Descripción	Referencia	Kits por...	Contenido del Kit	
DEL.	Leaf Spring Bushing All 30mm OD & 16mm ID	<b>MPU-1853K</b>	1	Bushings	
TRAS.	Leaf Spring Bushing All 30mm OD & 16mm ID, Early Models	<b>MPU-1853K</b>	1	Bushings	
TRAS.	Spring Front Eye Bushing 47mm OD Spring Eye Late Models	<b>MPU-1434K</b>	1	Inner Tubes, Bushings	
TRAS.	Spring Rear Eye Bushing 47mm OD Spring Eye Late Models	<b>MPU-1434K</b>	1	Inner Tubes, Bushings	
TRAS.	Spring Shackle Upper Bushing 30mm OD & 16mm ID, Late Models	<b>MPU-1853-4K</b>	1	Bushings	



## OPEL Opel Manta B Including Mk 1 Cavalier, Chevette &...

Página 1







Aplicaci...	Descripción	Referencia	Kits por...	Contenido del Kit	
DEL.	Control Arm Lower-Inner Bushing	<b>MPU-1550K</b>	1	Outer Shells, Inner Tubes, Bushings	
DEL.	Control Arm Upper-Front & Rear Kit	<b>MPU-1552K</b>	1	Inner Tubes, Bushings	
DEL.	Sub Frame to Body Mount Bushing Lower tie cross-member brace outrigger bar to chassis leg	<b>MPU-1753K</b>	1	Inner Tubes, Bushings	
DEL.	Sway Bar Link Bushing Kit	<b>MPU-1111K</b>	1	Bushings	
DEL.	Sway Bar Mount To Chassis Bushing Measure bar diameter 21,22mm available	<b>MPU-1695-__K</b>	1	Bushings	
TRAS.	Panhard Rod Bushing	<b>MPU-0030K</b>	1	Bushings	
TRAS.	Sway Bar Mount To Chassis Bushing Measure bar diameter 12,15,16,18mm available	<b>MPU-1812-__K</b>	1	Bushings	

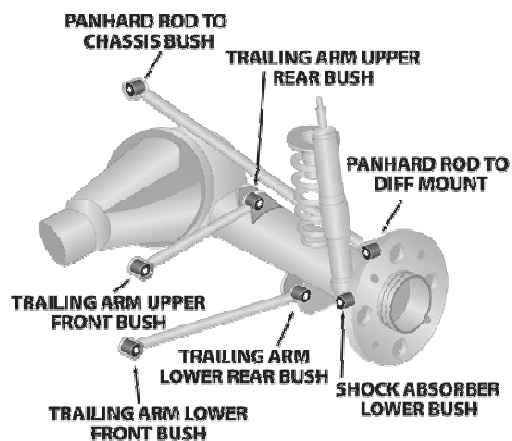
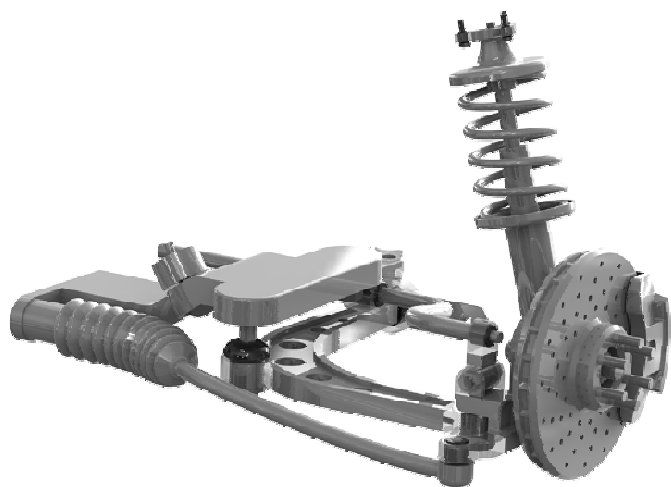

## OPEL Opel Manta B Including Mk 1 Cavalier, Chevette &...

Página 2 (Continúa)



Aplicaci...	Descripción	Referencia	Kits por...	Contenido del Kit	
TRAS.	Trailing Arm Lower Front Bushing	<b>MPU-0403K</b>	1	Bushings, Inner Tubes	
TRAS.	Trailing Arm Lower Rear Bushing	<b>MPU-0402K</b>	1	Bushings, Inner Tubes	



## OPEL Kadett Kadett - 1974 - 1985

Página 1

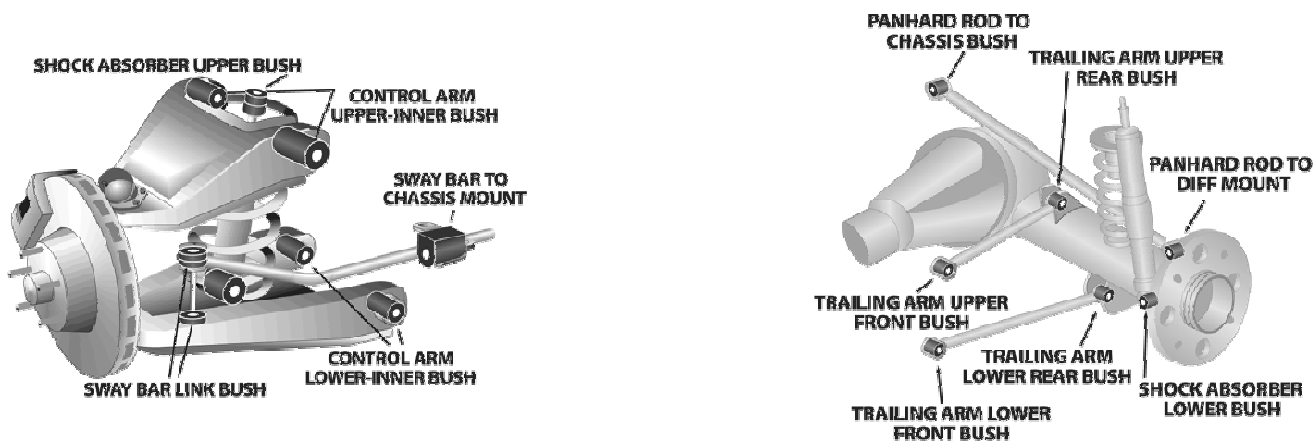

Aplicaci...	Descripción	Referencia	Kits por...	Contenido del Kit	
DEL.	Control Arm Lower-Inner Bushing	<b>MPU-0406K</b>	2	Bushings, Inner Tubes, Outer Shells	
DEL.	Control Arm Upper-Inner Front Bushing Re-use original shell	<b>MPU-0400K</b>	1	Bushings, Inner Tubes	
DEL.	Control Arm Upper-Inner Rear Kit Re-use original shell	<b>MPU-0401K</b>	1	Bushings, Inner Tubes	
DEL.	Shock Absorber Upper Bushing	<b>MPU-2755SK</b>	1	Bushings	
DEL.	Steering Coupling Bushing	<b>MPU-0121K</b>	1	Bushings, Inner Tubes	
DEL.	Steering Rack & Pinion Mount Bush....Manual Steering	<b>MPU-1116K</b>	1	Bushings	
DEL.	Sway Bar Link Bushing Kit	<b>MPU-2092BK</b>	1	Bushings	









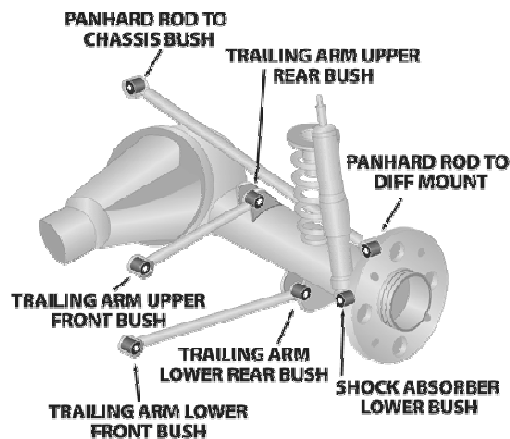
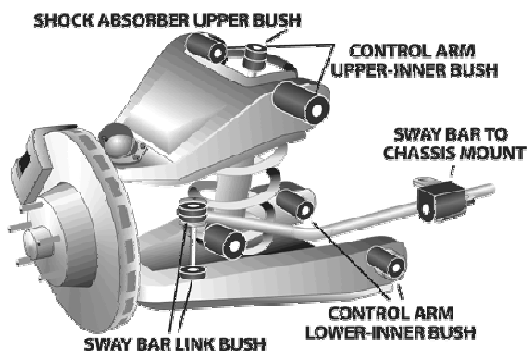



## OPEL Kadett Kadett - 1974 - 1985

Página 2 (Continúa)





Aplicaci...	Descripción	Referencia	Kits por...	Contenido del Kit	
DEL.	Sway Bar Mount To Chassis Bushing Measure bar diameter 14,16,18,19,20,23,24,25,26,27,28,30	<b>MPU-1453-__K</b>	1	Bushings	
TRAS.	Panhard Rod Bushing	<b>MPU-0030K</b>	1	Bushings	
TRAS.	Shock Absorber Lower Bushing	<b>MPU-2178-16K</b>	1	Bushings	
TRAS.	Shock Absorber Upper Bushing	<b>MPU-2755SK</b>	1	Bushings	
TRAS.	Sway Bar Link Bushing Kit	<b>MPU-0513K</b>	1	Inner Tubes, Bushings	
TRAS.	Sway Bar Mount To Chassis Bushing Measure bar diameter 13,14,15,16,17,18,20mm available	<b>MPU-0514-__K</b>	1	Bushings	
TRAS.	Trailing Arm Lower Front Bushing	<b>MPU-0402K</b>	1	Bushings, Inner Tubes	

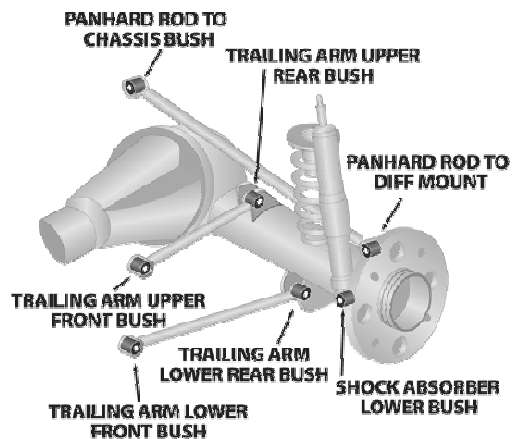
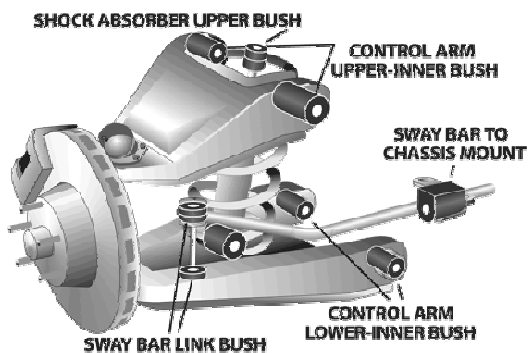

## OPEL Kadett Kadett - 1974 - 1985

Página 3 (Continúa)





Aplicaci...	Descripción	Referencia	Kits por...	Contenido del Kit	
TRAS.	Trailing Arm Lower Rear Bushing	MPU-0403K	1	Bushings, Inner Tubes	

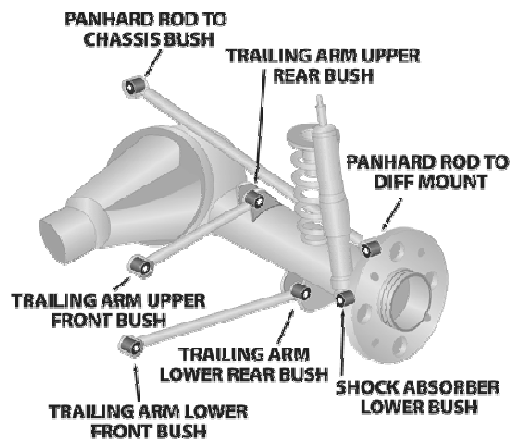
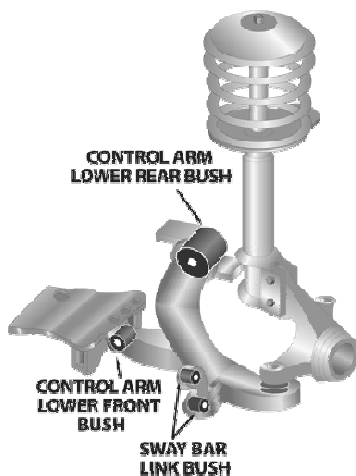

**SSANGYONG Musso 4 Door Wagon 4WD - 8/1996 - 5/1998**

Página 1



Aplicaci...	Descripción	Referencia	Kits por...	Contenido del Kit	
DEL.	Control Arm Upper-Inner Kit Re-use all original mounting washers	<b>MPU-2279K</b>	1	Inner Tubes, Bushings	



## SUBARU Leone L Series Sedan & Wagon 2WD & 4WD - 1979 -...

Página 1

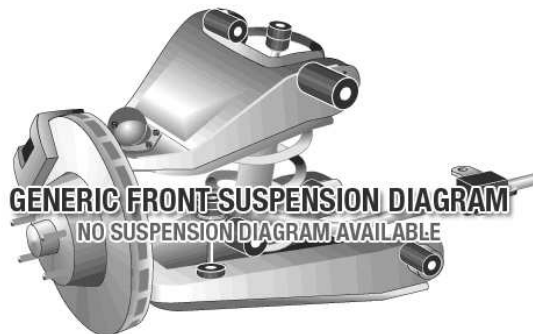
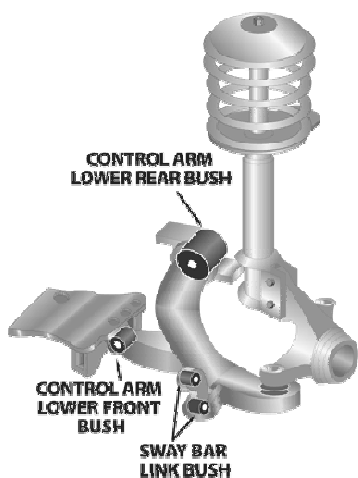







Aplicaci...	Descripción	Referencia	Kits por...	Contenido del Kit	
DEL.	Control Arm Lower-Inner Bushing To fit arm with hole inside diameter of 28mm	<b>MPU-1097K</b>	1	Bushings, Inner Tubes	
DEL.	Control Arm Lower-Inner Bushing To fit arm with hole inside diameter of 24mm	<b>MPU-1691K</b>	1	Bushings, Inner Tubes	
DEL.	Strut Bar To Chassis Mount Kit To suit 17mm outside diameter shaft	<b>MPU-1098K</b>	1	Bushings	
DEL.	Strut Bar To Chassis Mount Kit To suit 18mm shaft diameter	<b>MPU-2534K</b>	1	Bushings	
DEL.	Sway Bar Link To Lower Arm Bushing 1984 to 1994 L12	<b>MPU-2755SK</b>	1	Bushings	
DEL.	Sway Bar Link To Lower Arm Bushing 1/1987 to 6/1994	<b>MPU-3004K</b>	1	Inner Tubes, Bushings	
DEL.	Sway Bar Link Upper Bushing Sway bar end bush	<b>MPU-2239K</b>	1	Bushings, Inner Tubes	

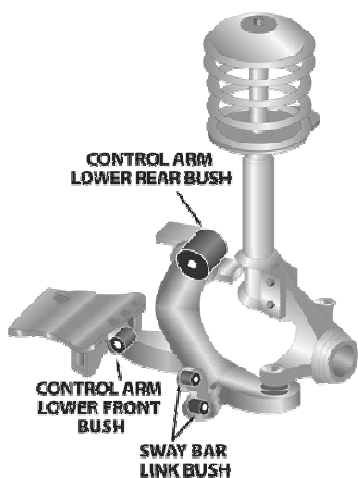

## SUBARU Leone L Series Sedan & Wagon 2WD & 4WD - 1979 -...

Página 2 (Continúa)







Aplicaci...	Descripción	Referencia	Kits por...	Contenido del Kit	
DEL.	Sway Bar Mount To Chassis Bushing Only suits 10/1979 to 1984	MPU-1100-__K	1	Bushings	
DEL.	Sway Bar Mount To Chassis Bushing Measure bar diameter 13,14,15,16,17,18,19,20,21,22,23,24,25.4 &...	MPU-1383-__K	1	Bushings	
DEL.	Sway Bar To Strut Arm D Bushing 10/1979 to 1984, Should always be 17mm	MPU-1099-__K	1	Bushings	
TRAS.	Differential Pinion Mount Bushing Pinion to cross-member mount, horizontally mounted, must remove original shell for fitment.	MPU-3005K	1	Inner Tubes, Bushings	
TRAS.	Trailing Arm - Bushing Kit Re-use original shell	MPU-1144K	1	Bushings, Inner Tubes	

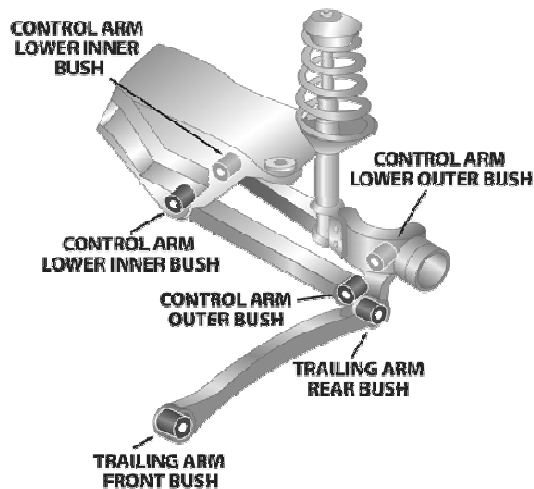
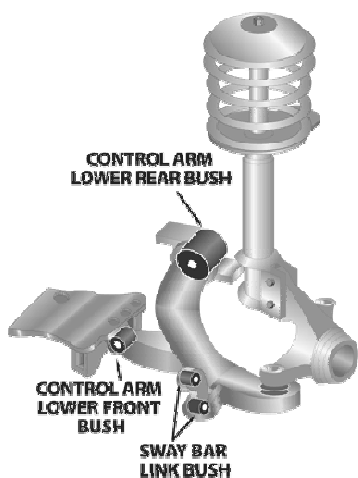

SUBARU Legacy/ Liberty BE / BH - 11/1998 - 9/2003

Página 1









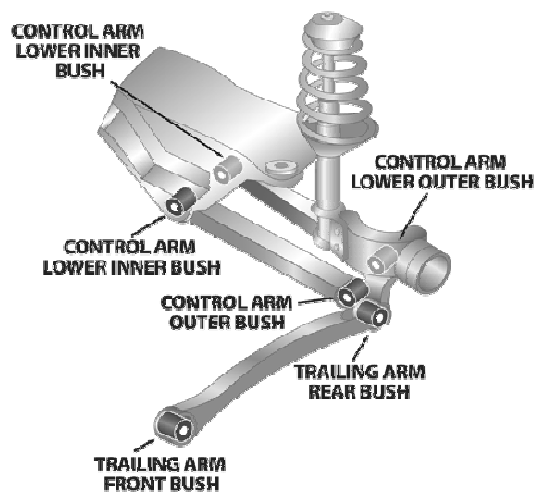
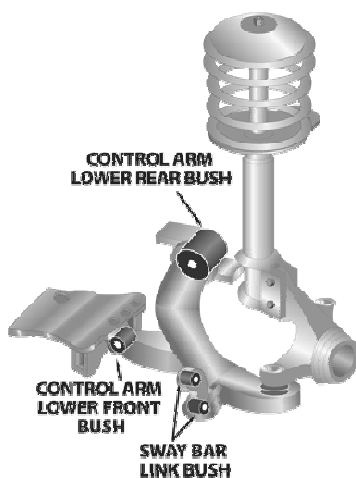

Aplicaci...	Descripción	Referencia	Kits por...	Contenido del Kit	
DEL.	Control Arm Lower-Inner Front Kit Tube length 55mm	<b>MPU-1390K</b>	1	Washers, Inner Tubes, Bushings	
DEL.	Control Arm Lower-Inner Front Kit Tube length 61mm	<b>MPU-2429K</b>	1	Inner Tubes, Bushings	
DEL.	Control Arm Lower-Inner Rear Eccentric Autocross Kit, Anti Lift, & Caster Increase both sides, 2 x offset bushings per kit.	<b>MPU-1388AK</b>	1	Washers, Outer Shells, Inner Tubes, Bushings	
DEL.	Control Arm Lower-Inner Rear Kit Standard replacement	<b>MPU-1387K</b>	1	Outer Shells, Inner Tubes, Bushings	
DEL.	Control Arm Lower-Inner Rear Kit PS Standard DS Decrease, to provide caster spread	<b>MPU-1388K</b>	1	Outer Shells, Inner Tubes, Bushings	
DEL.	Gear-linkage, Support Bar, Front Bush Competition Use	<b>MPU-2462K</b>	1	Inner Tubes, Bushings	
DEL.	Gear-linkage, Support Bar, Front Bush	<b>MPU-2704K</b>	1	Bushings	



## SUBARU Legacy/ Liberty BE / BH - 11/1998 - 9/2003

Página 2 (Continúa)





Aplicaci...	Descripción	Referencia	Kits por...	Contenido del Kit	
DEL.	Gearbox Cross Member Isolator Mount	<b>MPU-2358K</b>	1	Bushings	
DEL.	Steering Rack & Pinion Mount Bushing	<b>MPU-2580K</b>	1	Bushings	
DEL.	Sway Bar Link Bushing Kit 2 x large bushings & 2 x small bushings	<b>MPU-1200K</b>	1	Inner Tubes, Bushings	 SPF1200K
DEL.	Sway Bar Mount To Chassis Bushing Measure bar diameter 17,18,19,20,21,22,23,24,25.4 & 27mm available	<b>MPU-1617-__K</b>	1	Bushings	
TRAS.	Control Arm Lower-Inner & Outer Kit	<b>MPU-3391K</b>	1	Outer Shells, Inner Tubes, Bushings	 SPF3391K
TRAS.	Control Arm Upper-Outer Bushing	<b>MPU-3389K</b>	1	Inner Tubes, Bushings	
TRAS.	Sway Bar Link Bushing Kit All 4 x bushes are the same size	<b>MPU-1200AK</b>	1	Inner Tubes, Bushings	 1200AK

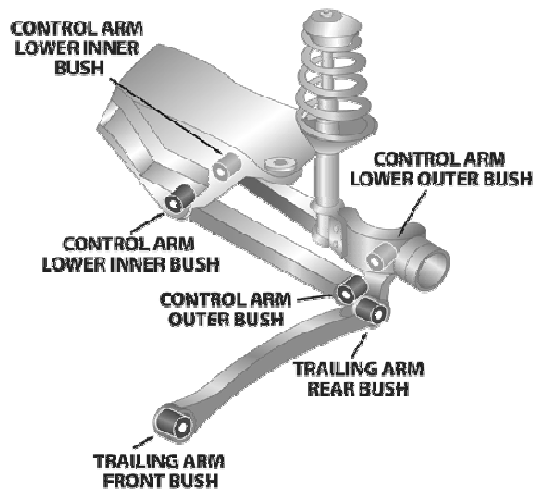
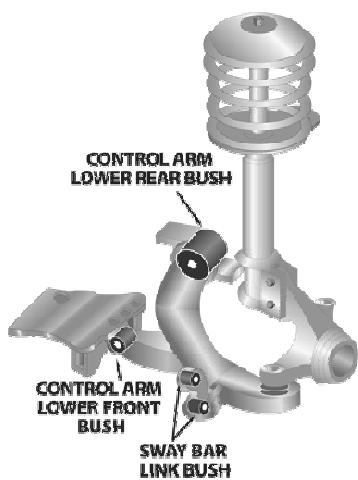

SUBARU Legacy/ Liberty BE / BH - 11/1998 - 9/2003

Página 3 (Continúa)



Aplicaci...	Descripción	Referencia	Kits por...	Contenido del Kit	
TRAS.	Sway Bar Mount To Chassis Bushing Measure bar diameter 13,14,15,16,17,18,19,20,21,22,23,24,25.4 &...	MPU-1383-__K	1	Bushings	
TRAS.	Toe Control Arm - Outer Bushing	MPU-3392K	1	Inner Tubes, Bushings	
TRAS.	Trailing Arm - Front Bushing	MPU-3388-70K	1	Outer Shells, Inner Tubes, Bushings	





**SUBARU Legacy/ Liberty BL / BP 4th Generation - 9/2003 - 2009**

Página 1

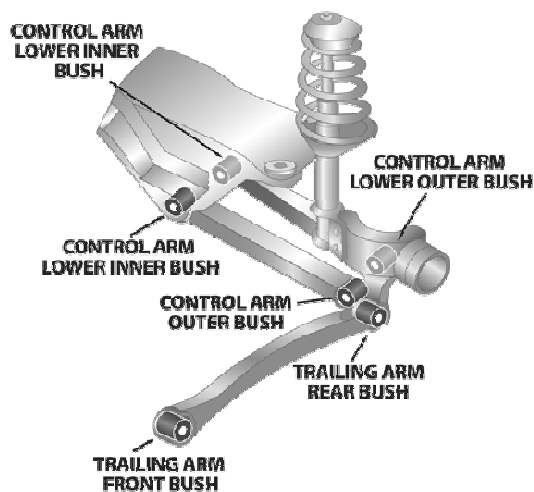







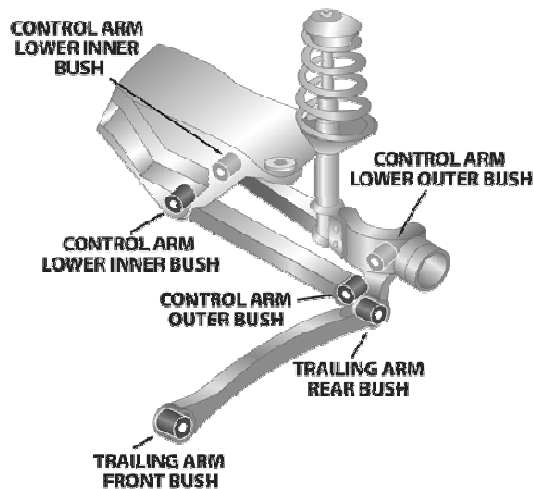

Aplicaci...	Descripción	Referencia	Kits por...	Contenido del Kit	
DEL.	Control Arm Lower-Inner Front Kit	<b>MPU-3091K</b>	1	Washers, Inner Tubes, Bushings	 SPF3091K
DEL.	Control Arm Lower-Inner Rear Eccentric 1 x offset bushing & 1 x standard bushing in kit	<b>MPU-2802K</b>	1	Bushings, Outer Shells, Inner Tubes	
DEL.	Control Arm Lower-Inner Rear Eccentric 2 x offset bushings in kit	<b>MPU-2803K</b>	1	Bushings, Outer Shells, Inner Tubes	
DEL.	Control Arm Lower-Inner Rear Kit 2 x Standard bushings per kit	<b>MPU-2801K</b>	1	Outer Shells, Inner Tubes, Bushings	 SPF2801K
DEL.	Steering Rack & Pinion Mount Bushing Passenger side bushing replaces original part number 34115AG000 ** THIS KIT INCLUDES...	<b>MPU-2889K</b>	1	Nuts, Rods, Washers, Outer Shells, Inner Tubes, Bushings	 SPF2889K
DEL.	Steering Rack & Pinion Mount Bushing ** DOES NOT INCLUDE REMOVAL TOOL **	<b>MPU-2889BK</b>	1	Inst Sheet, Inner Tubes, Bushings	 SPF2889BK
DEL.	Sway Bar Mount Bushing Measure bar diameter, 18,20,21,22,23,24,25mm available	<b>MPU-3096-__K</b>	1	Bushings	 SPF3096-__K



**SUBARU Legacy/ Liberty BL / BP 4th Generation - 9/2003 - 2009**

Página 2 (Continúa)









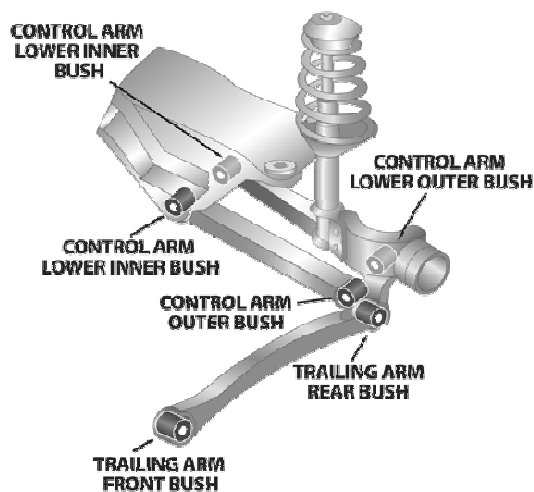
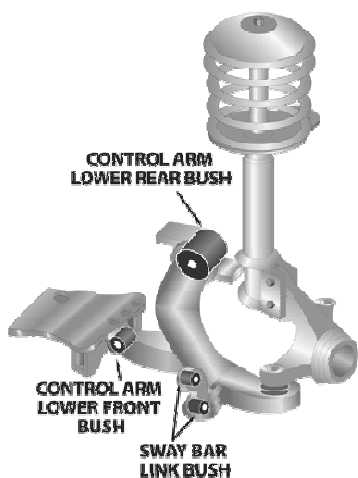

Aplicaci...	Descripción	Referencia	Kits por...	Contenido del Kit	
TRAS.	Control Arm Lower-Inner & Outer Kit	<b>MPU-3391K</b>	1	Outer Shells, Inner Tubes, Bushings	
TRAS.	Control Arm Upper-Outer Bushing	<b>MPU-3389K</b>	1	Inner Tubes, Bushings	
TRAS.	Cross-member Supplement Washers Upper & Lower position, Only suited to vehicles with voids in original bushing top & bottom.	<b>MPU-3007K</b>	1	Bushings	
TRAS.	Cross-member Supplement Washers Bottom location position only, when vehicle has solid top mount, fits into original rubber bushing	<b>MPU-3008K</b>	1	Bushings	
TRAS.	Toe Control Arm - Outer Bushing	<b>MPU-3392K</b>	1	Inner Tubes, Bushings	
TRAS.	Trailing Arm - Front Bushing	<b>MPU-3388-70K</b>	1	Outer Shells, Inner Tubes, Bushings	



## SUBARU Legacy/ Liberty BC / BF - 10/1989 - 5/1994

Página 1







Aplicaci...	Descripción	Referencia	Kits por...	Contenido del Kit	
DEL.	Control Arm Lower-Front Bushing Tube length 55mm	<b>MPU-1390K</b>	1	Washers, Inner Tubes, Bushings	
DEL.	Control Arm Lower-Inner Rear Kit Standard	<b>MPU-1387K</b>	1	Outer Shells, Inner Tubes, Bushings	
DEL.	Control Arm Lower-Inner Rear Kit PS Standard DS Decrease, to provide caster spread	<b>MPU-1388K</b>	1	Outer Shells, Inner Tubes, Bushings	
DEL.	Steering Rack & Pinion Mount Bushing 25mm Bracket width, passenger side	<b>MPU-1835K</b>	1	Bushings	
DEL.	Steering Rack & Pinion Mount Bushing 30mm bracket width, passenger side	<b>MPU-1972K</b>	1	Bushings	
DEL.	Sway Bar Link Bushing Kit 2 x large bushings & 2 x small bushings	<b>MPU-1200K</b>	1	Inner Tubes, Bushings	
DEL.	Sway Bar Mount To Chassis Bushing Measure bar diameter as 16,117,18,19,20,21,22,24 & 26mm available.	<b>MPU-0362-__K</b>	1	Bushings	

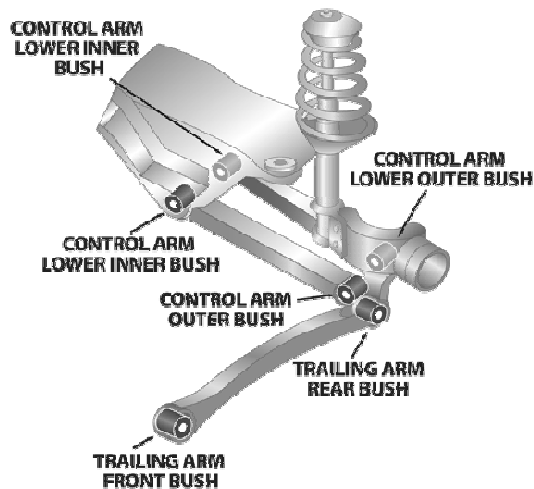
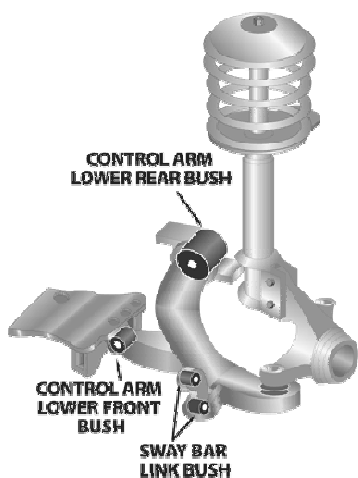

**SUBARU Legacy/ Liberty BC / BF - 10/1989 - 5/1994**

Página 2 (Continúa)









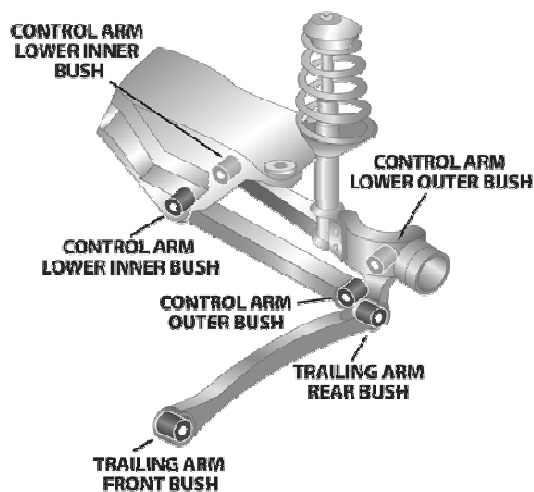
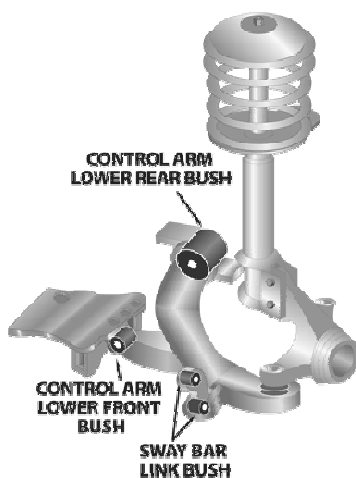

Aplicaci...	Descripción	Referencia	Kits por...	Contenido del Kit	
TRAS.	Sway Bar Link Bushing Kit All 4 x bushes are the same size	<b>MPU-1200AK</b>	1	Inner Tubes, Bushings	
TRAS.	Sway Bar Mount To Chassis Bushing Measure bar diameter as 16,117,18,19,20,21,22,24 & 26mm available.	<b>MPU-0362-__K</b>	1	Bushings	



## SUBARU Legacy/ Liberty BD / BG - 6/1994 - 1/1999

Página 1



Aplicaci...	Descripción	Referencia	Kits por...	Contenido del Kit	
DEL.	Control Arm Lower-Front Bushing Tube length 55mm	<b>MPU-1390K</b>	1	Washers, Inner Tubes, Bushings	
DEL.	Control Arm Lower-Inner Rear Eccentric	<b>MPU-1388AK</b>	1	Washers, Outer Shells, Inner Tubes, Bushings	
DEL.	Control Arm Lower-Inner Rear Kit Standard	<b>MPU-1387K</b>	1	Outer Shells, Inner Tubes, Bushings	
DEL.	Control Arm Lower-Inner Rear Kit PS Standard DS Decrease, to provide caster spread	<b>MPU-1388K</b>	1	Outer Shells, Inner Tubes, Bushings	
DEL.	Gear-linkage, Support Bar, Front Bush	<b>MPU-2704K</b>	1	Bushings	
DEL.	Steering Rack & Pinion Mount Bushing 25mm Bracket width, passenger side	<b>MPU-1835K</b>	1	Bushings	
DEL.	Steering Rack & Pinion Mount Bushing 30mm bracket width, passenger side	<b>MPU-1972K</b>	1	Bushings	



## SUBARU Legacy/ Liberty BD / BG - 6/1994 - 1/1999

Página 2 (Continúa)

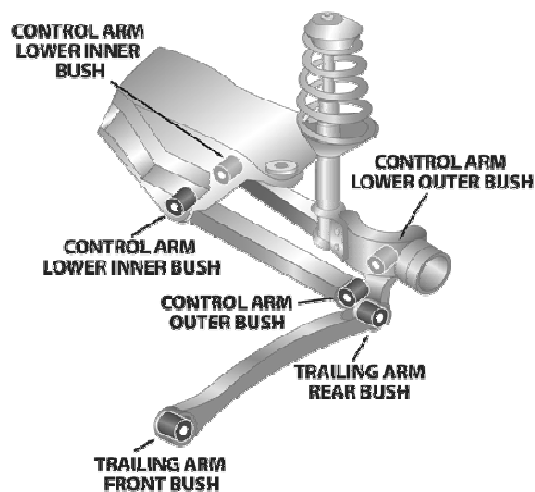
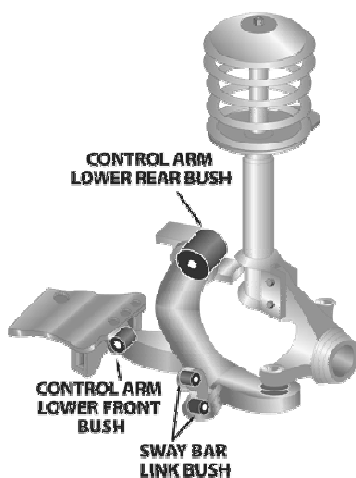







Aplicaci...	Descripción	Referencia	Kits por...	Contenido del Kit	
DEL.	Sway Bar Link Bushing Kit 2 x large bushings & 2 x small bushings	<b>MPU-1200K</b>	1	Inner Tubes, Bushings	
DEL.	Sway Bar Mount To Chassis Bushing Measure bar diameter 13,14,15,16,17,18,19,20,21,22,23,24,25.4 &...	<b>MPU-1383-__K</b>	1	Bushings	
TRAS.	Control Arm Lower-Inner Bushing	<b>MPU-1492K</b>	1	Inner Tubes, Bushings	
TRAS.	Control Arm Lower-Outer Bushing	<b>MPU-1497K</b>	1	Inner Tubes, Bushings	
TRAS.	Cross-member Supplement Washers	<b>MPU-1978K</b>	1	Bushings	
TRAS.	Differential Support Bracket Mount Kit	<b>MPU-2664K</b>	1	Washers, Inner Tubes, Bushings	
TRAS.	Sway Bar Link Bushing Kit All 4 x bushes are the same size	<b>MPU-1200AK</b>	1	Inner Tubes, Bushings	

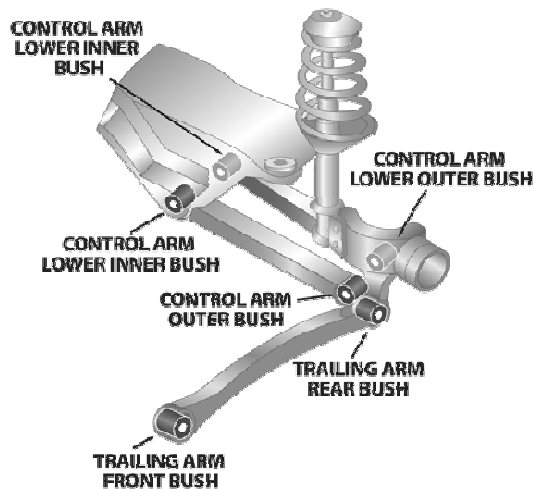
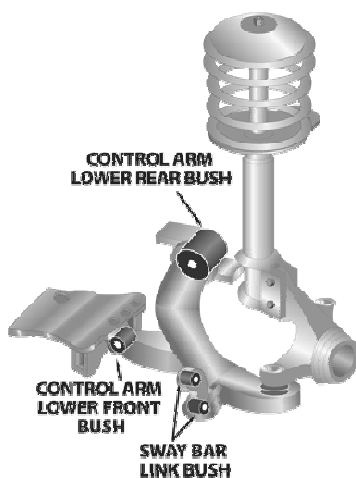

## SUBARU Legacy/ Liberty BD / BG - 6/1994 - 1/1999

Página 3 (Continúa)









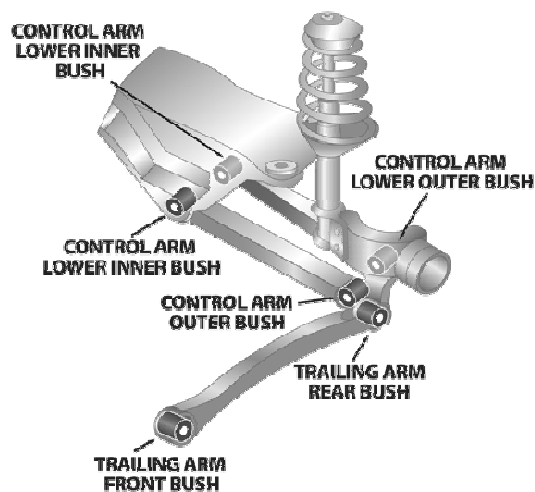
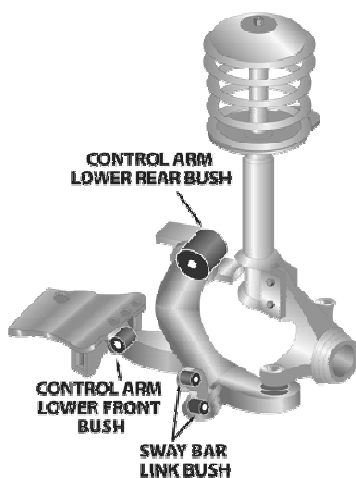

Aplicaci...	Descripción	Referencia	Kits por...	Contenido del Kit	
TRAS.	Sway Bar Link Bushing Kit	<b>MPU-1384AK</b>	1	Inner Tubes, Bushings	
TRAS.	Sway Bar Mount To Chassis Bushing Measure bar diameter 13,14,15,16,17,18,19,20,21,22,23,24,25.4 &...	<b>MPU-1383-__K</b>	1	Bushings	
TRAS.	Sway Bar Mount To Chassis Bushing Wagon, measure bar diameter 14,15,16,17,18,19,20,21,22,23 & 24mm...	<b>MPU-1713-__K</b>	1	Bushings	
TRAS.	Trailing Arm Lower Front Bushing	<b>MPU-1491K</b>	1	Inner Tubes, Bushings	
TRAS.	Trailing Arm Lower Rear Bushing	<b>MPU-1907K</b>	1	Inner Tubes, Bushings	



## SUBARU WRX Impreza, Sportswagon & Hatch GD and GG...

Página 1



Aplicaci...	Descripción	Referencia	Kits por...	Contenido del Kit	
DEL.	Control Arm Lower-Inner Rear Eccentric Autocross Kit, Anti Lift, & Caster Increase both sides, 2 x offset bushings per kit.	<b>MPU-1388AK</b>	1	Washers, Outer Shells, Inner Tubes, Bushings	 SPF1388AK
DEL.	Control Arm Lower-Inner Rear Kit Standard	<b>MPU-1387K</b>	1	Outer Shells, Inner Tubes, Bushings	 SPF1387K
DEL.	Control Arm Lower-Inner Rear Kit PS Standard DS Decrease, to provide caster spread	<b>MPU-1388K</b>	1	Outer Shells, Inner Tubes, Bushings	 1388K
DEL.	Control Arm-Inner Front Bushing Tube length 55mm	<b>MPU-1390K</b>	1	Washers, Inner Tubes, Bushings	 SPF1390K
DEL.	Control Arm-Inner Front Bushing Tube length 61mm	<b>MPU-2429K</b>	1	Inner Tubes, Bushings	
DEL.	Gear-linkage, Support Bar, Front Bush 6 Speed - Replaces original bushing 35035FE010, 40mm outside diameter bushing	<b>MPU-2462K</b>	1	Inner Tubes, Bushings	
DEL.	Gear-linkage, Support Bar, Front Bush 5 Speed - Replaces original bushing 35035AC030, 44mm outside diameter bushing	<b>MPU-2704K</b>	1	Bushings	





## SUBARU WRX Impreza, Sportswagon & Hatch GD and GG...

Página 2 (Continúa)

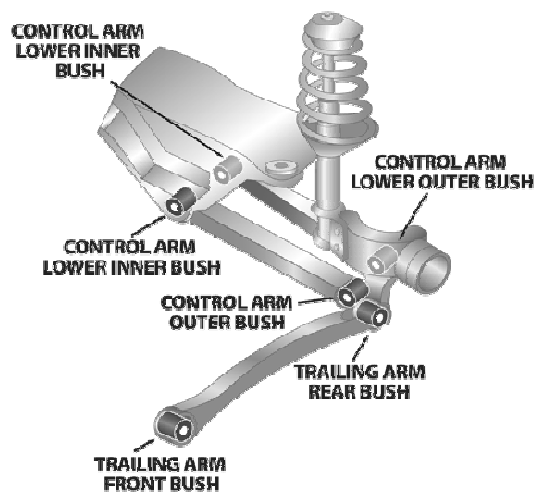
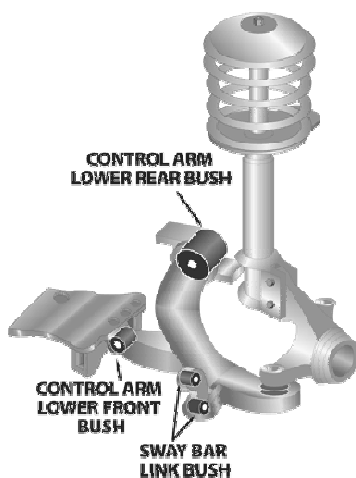







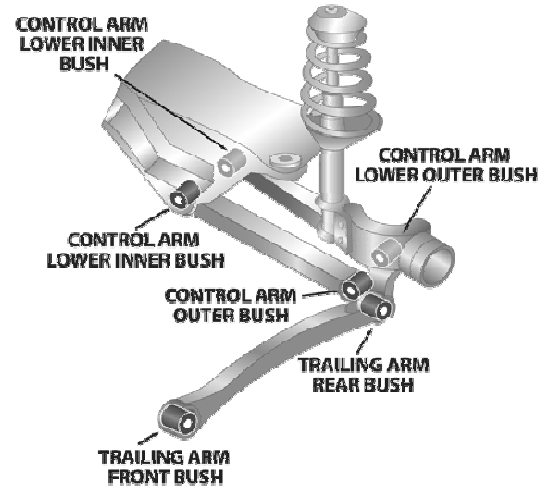
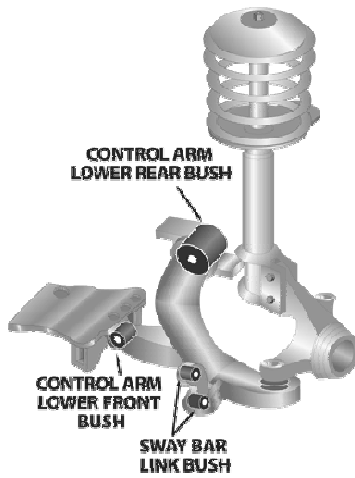

Aplicaci...	Descripción	Referencia	Kits por...	Contenido del Kit	
DEL.	Gearbox Cross Member Isolator Mount	<b>MPU-2358K</b>	1	Bushings	
DEL.	Steering Rack & Pinion Mount Bushing 30mm bracket width, passenger side	<b>MPU-1972K</b>	1	Bushings	
DEL.	Steering Rack & Pinion Mount Bushing Suited to limited vehicle production run with 48mm diameter housing.	<b>MPU-1972-48K</b>	1	Bushings	
DEL.	Sway Bar Mount To Chassis Bushing Measure bar diameter 17,18,19,20,21,22,23,24,25.4 & 27mm available	<b>MPU-1617-__K</b>	1	Bushings	
F & R	SuperPro Alignment Kit (10/2000-9/2004) FRONT= SPF1388AKx1 REAR=KCA414 Camber Bolts. See any notes against individual part...	<b>MPK-118K</b>	1	Outer Shells, Inner Tubes, Bushings, Bushings	
F & R	SuperPro Enhancement Kit (10/2000-10/2002) SPF1390Kx1, SPF1388AKx1, SPF1972Kx1, SPF1463Kx1, SPF1491Kx1, SPF1907Kx1. See any notes listed against individual part numbers...	<b>MPK-119K</b>	1	Washers, Outer Shells, Inner Tubes, Bushings	



## SUBARU WRX Impreza, Sportswagon & Hatch GD and GG...

Página 3 (Continúa)







Aplicaci...	Descripción	Referencia	Kits por...	Contenido del Kit	
F & R	SuperPro Enhancement Kit (10/2002-9/2004) SPF2429Kx1, SPF1388AKx1, SPF1972Kx1, SPF1463Kx1, SPF1491Kx1, SPF1907Kx1. See any notes listed against individual part numbers...	<b>MPK-120K</b>	1	Washers, Outer Shells, Inner Tubes, Bushings	
TRAS.	Control Arm Lower-Inner & Outer Kit Measure arm housing ID upon removal of OE rubber bushing, this kit suited to 34mm inside...	<b>MPU-1463K</b>	1	Washers, Inner Tubes, Bushings	
TRAS.	Cross-member Supplement Washers Anti tramp bushing	<b>MPU-1978K</b>	1	Bushings	
TRAS.	Differential Support Bracket Mount Kit Competition use recommended	<b>MPU-2433K</b>	1	Inner Tubes, Bushings	
TRAS.	Sway Bar Link Bushing Kit	<b>MPU-1384AK</b>	1	Inner Tubes, Bushings	
TRAS.	Sway Bar Mount To Chassis Bushing Measure bar diameter 13,14,15,16,17,18,19,20,21,22,23,24,25.4 &...	<b>MPU-1383-__K</b>	1	Bushings	

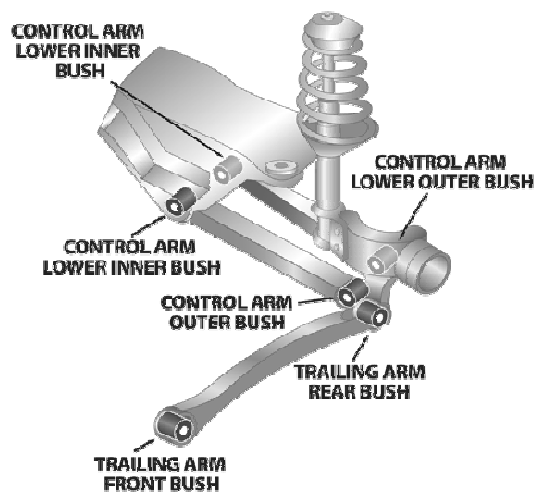
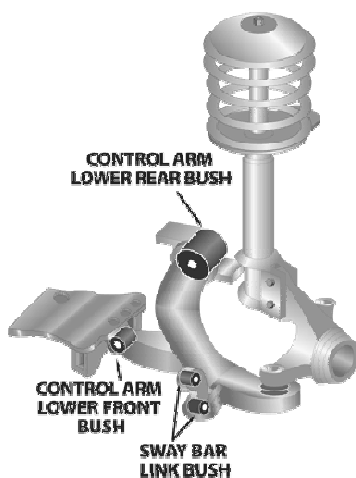

## SUBARU WRX Impreza, Sportswagon & Hatch GD and GG...

Página 4 (Continúa)









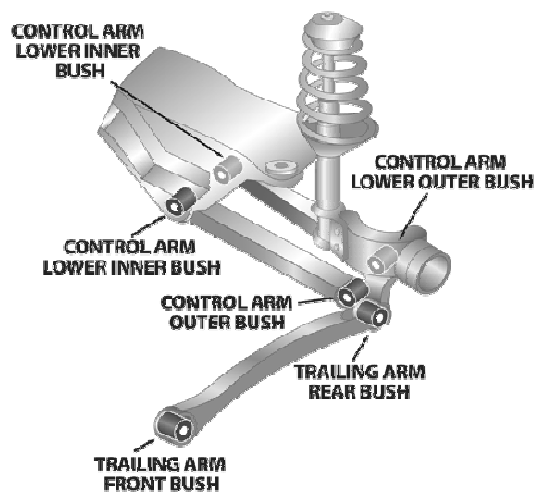
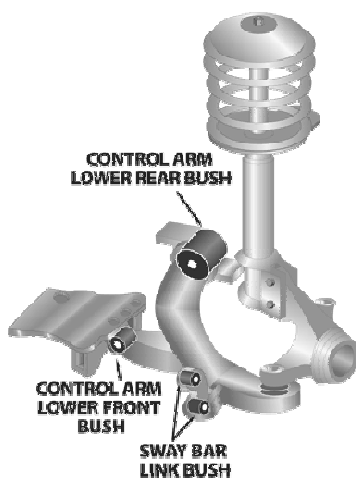

Aplicaci...	Descripción	Referencia	Kits por...	Contenido del Kit	
TRAS.	Trailing Arm Lower Front Bushing	<b>MPU-1491K</b>	1	Inner Tubes, Bushings	
TRAS.	Trailing Arm Lower Rear Bushing	<b>MPU-1907K</b>	1	Inner Tubes, Bushings	



## SUBARU WRX Impreza, Sportswagon & Hatch GD and GG...

Página 1









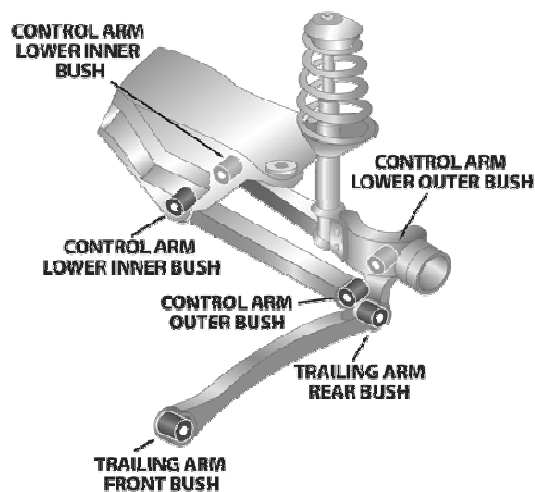
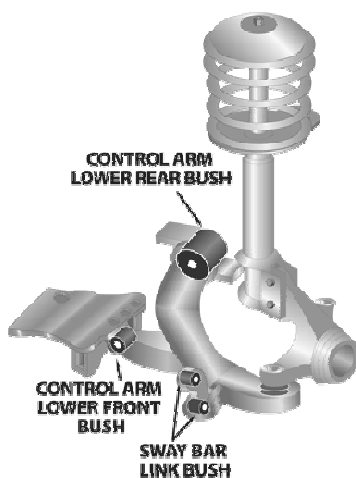

Aplicaci...	Descripción	Referencia	Kits por...	Contenido del Kit	
DEL.	Control Arm Lower-Inner Rear Eccentric Autocross Kit, Anti Lift, & Caster Increase both sides, 2 x offset bushings per kit.	<b>MPU-1388AK</b>	1	Washers, Outer Shells, Inner Tubes, Bushings	
DEL.	Control Arm Lower-Inner Rear Kit Standard	<b>MPU-1387K</b>	1	Outer Shells, Inner Tubes, Bushings	
DEL.	Control Arm Lower-Inner Rear Kit PS Standard DS Decrease, to provide caster spread	<b>MPU-1388K</b>	1	Outer Shells, Inner Tubes, Bushings	
DEL.	Control Arm-Inner Front Bushing Tube length 61mm	<b>MPU-2429K</b>	1	Inner Tubes, Bushings	
DEL.	Gear-linkage, Support Bar, Front Bush 6 Speed - Replaces original bushing 35035FE010, 40mm outside diameter bushing	<b>MPU-2462K</b>	1	Inner Tubes, Bushings	
DEL.	Gear-linkage, Support Bar, Front Bush 5 Speed - Replaces original bushing 35035AC030, 44mm outside diameter bushing	<b>MPU-2704K</b>	1	Bushings	
DEL.	Gearbox Cross Member Isolator Mount	<b>MPU-2358K</b>	1	Bushings	



## SUBARU WRX Impreza, Sportswagon & Hatch GD and GG...

Página 2 (Continúa)









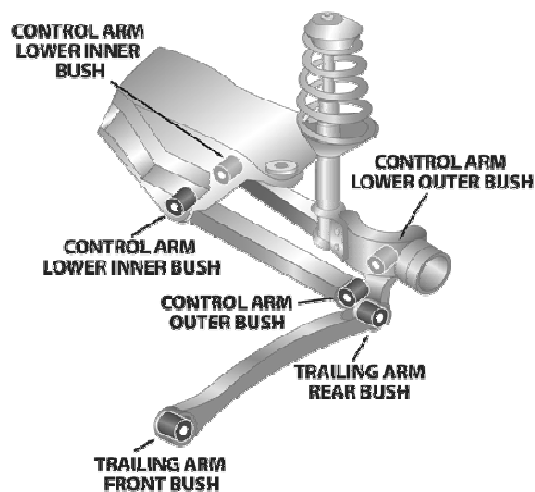
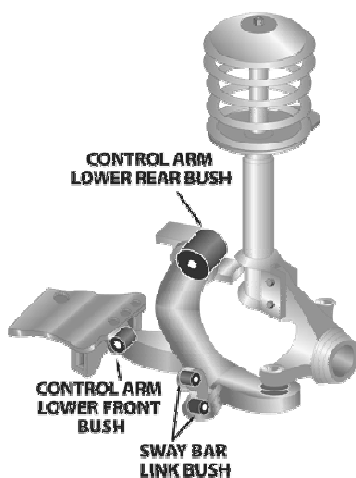

Aplicaci...	Descripción	Referencia	Kits por...	Contenido del Kit	
DEL.	Steering Rack & Pinion Mount Bushing 30mm bracket width, passenger side	<b>MPU-1972K</b>	1	Bushings	
DEL.	Steering Rack & Pinion Mount Bushing Models 2005-2007 ** THIS KIT INCLUDES O.E BUSH REMOVAL TOOL **	<b>MPU-2648K</b>	1	Nuts, Rods, Washers, Outer Shells, Inner Tubes, Bushings	
DEL.	Steering Rack & Pinion Mount Bushing Models 2005-2007 ** DOES NOT INCLUDE REMOVAL TOOL **	<b>MPU-2648BK</b>	1	Inst Sheet, Inner Tubes, Bushings	
DEL.	Sway Bar Link Bushing Kit	<b>MPU-1384K</b>	1	Inner Tubes, Bushings	
DEL.	Sway Bar Mount To Chassis Bushing Measure bar diameter 17,18,19,20,21,22,23,24,25.4 & 27mm available	<b>MPU-1617-__K</b>	1	Bushings	
F & R	SuperPro Alignment Kit (10/2000-9/2004) FRONT= SPF1388AKx1 REAR=KCA414 Camber Bolts. See any notes against individual part...	<b>MPK-118K</b>	1	Outer Shells, Inner Tubes, Bushings, Bushings	
F & R	SuperPro Enhancement Kit (10/2002-9/2004) SPF2429Kx1, SPF1388AKx1, SPF1972Kx1, SPF1463Kx1, SPF1491Kx1, SPF1907Kx1. See...	<b>MPK-120K</b>	1	Washers, Outer Shells, Inner Tubes, Bushings	



## SUBARU WRX Impreza, Sportswagon & Hatch GD and GG...

Página 3 (Continúa)





Aplicaci...	Descripción	Referencia	Kits por...	Contenido del Kit	
F & R	below.	<b>MPK-120K</b>	1	Washers, Outer Shells, Inner Tubes, Bushings	
TRAS.	Control Arm Lower-Inner & Outer Kit Measure arm housing ID upon removal of OE rubber bushing, this kit suited to 34mm inside...	<b>MPU-1463K</b>	1	Washers, Inner Tubes, Bushings	
TRAS.	Cross-member Supplement Washers GDB, Race or Track only, possible NVH in street car.	<b>MPU-2701K</b>	1	Bushings	
TRAS.	Differential Support Bracket Mount Kit Competition use recommended	<b>MPU-2433K</b>	1	Inner Tubes, Bushings	
TRAS.	Sway Bar Link Bushing Kit	<b>MPU-1384AK</b>	1	Inner Tubes, Bushings	
TRAS.	Sway Bar Mount Bushing Measure bar diameter, 14,16,17,18,20,21,22,24mm available.	<b>MPU-2791-__K</b>	1	Bushings	
TRAS.	Trailing Arm Lower Front Bushing	<b>MPU-1491K</b>	1	Inner Tubes, Bushings	

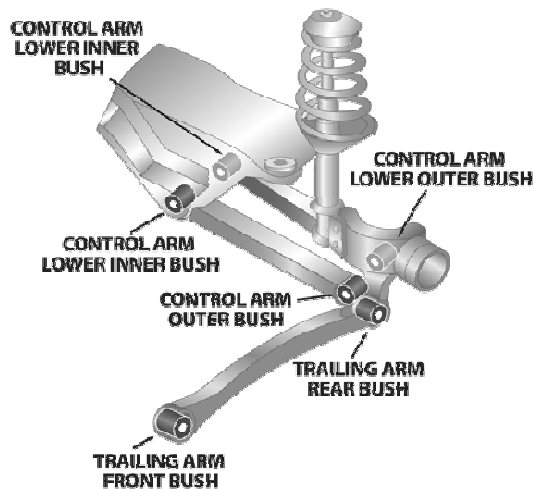
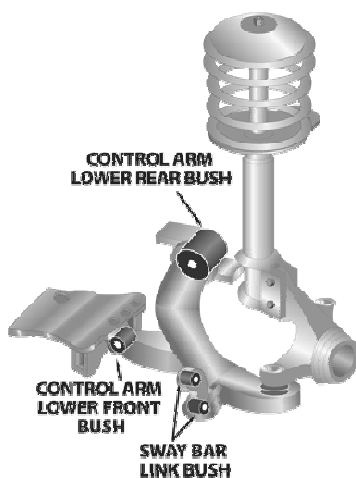

**SUBARU WRX Impreza, Sportswagon & Hatch GD and GG...**

Página 4 (Continúa)









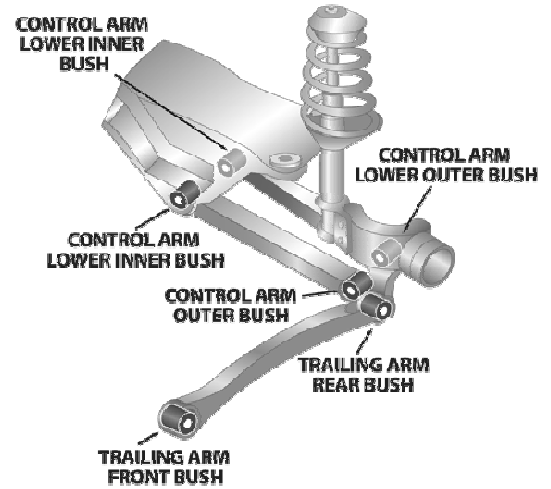
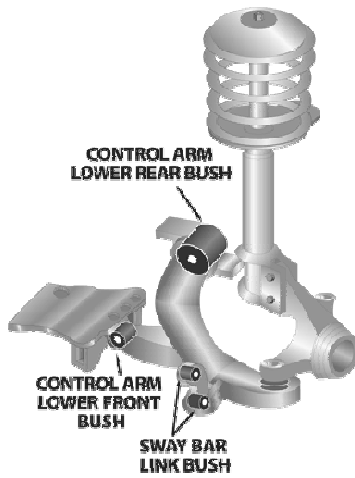

Aplicaci...	Descripción	Referencia	Kits por...	Contenido del Kit	
TRAS.	Trailing Arm Lower Rear Bushing	MPU-1907K	1	Inner Tubes, Bushings	



## SUBARU WRX Impreza, Sportswagon & Hatch GD STi - 2005 -...

Página 1



Aplicaci...	Descripción	Referencia	Kits por...	Contenido del Kit	
DEL.	Control Arm Lower-Inner Rear Eccentric Autocross Kit, Anti Lift, & Caster Increase both sides, 2 x offset bushings per kit.	<b>MPU-1388AK</b>	1	Washers, Outer Shells, Inner Tubes, Bushings	
DEL.	Control Arm Lower-Inner Rear Kit 1 x Standard & 1 x Offset bushing in kit	<b>MPU-1388K</b>	1	Outer Shells, Inner Tubes, Bushings	
DEL.	Control Arm-Inner Front Bushing	<b>MPU-2429K</b>	1	Inner Tubes, Bushings	
DEL.	Control Arm-Inner Rear Bushing Standard replacement	<b>MPU-1387K</b>	1	Outer Shells, Inner Tubes, Bushings	
DEL.	Gear-linkage, Support Bar, Front Bush 6 Speed - Replaces original bushing 35035FE010, 40mm outside diameter bushing	<b>MPU-2462K</b>	1	Inner Tubes, Bushings	
DEL.	Gearbox Cross Member Isolator Mount	<b>MPU-2358K</b>	1	Bushings	
DEL.	Steering Rack & Pinion Mount Bush.....Power Steering ** THIS KIT INCLUDES O.E BUSH REMOVAL TOOL **	<b>MPU-2648K</b>	1	Nuts, Rods, Washers, Outer Shells, Inner Tubes, Bushings	









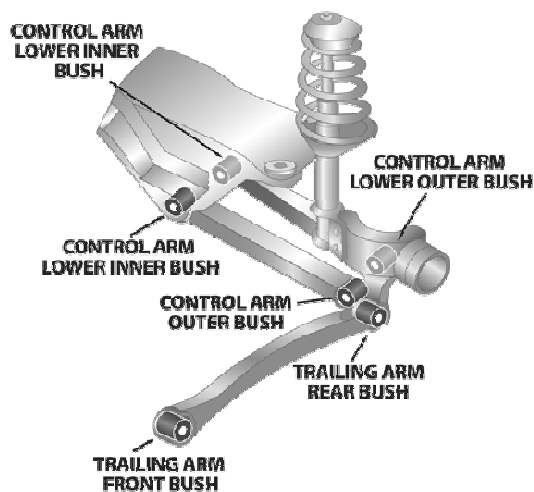
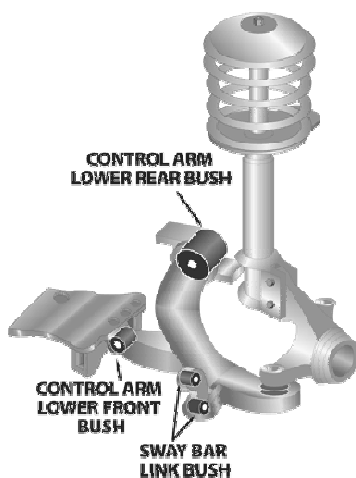



## SUBARU WRX Impreza, Sportswagon & Hatch GD STi - 2005 -...

Página 2 (Continúa)









Aplicaci...	Descripción	Referencia	Kits por...	Contenido del Kit	
DEL.	Steering Rack & Pinion Mount Bushing ** DOES NOT INCLUDE REMOVAL TOOL **	<b>MPU-2648BK</b>	1	Inst Sheet, Inner Tubes, Bushings	
DEL.	Sway Bar Mount To Chassis Bushing Measure bar diameter as 17,18,19,20,21,22,23,24,25.4 & 27mm available	<b>MPU-1617-__K</b>	1	Bushings	
F & R	Vehicle Master Kit SUITS STi MODELS ONLY CONTENTS - SPF2429K x 1,SPF1388AK x 1,SPF2648BK x 1,SPF2808K x 1,SPF1491K x...	<b>MPK-179K</b>	1	Washers, Inner Tubes, Bushings	
F & R	Vehicle Master Kit SUITS STi MODELS ONLY CONTENTS - SPF2429K x 1,SPF1388AK x 1,SPF2648BK x 1,SPF1463K x 1,SPF1491K x...	<b>MPK-192K</b>	1	Washers, Inner Tubes, Bushings	
TRAS.	Control Arm Lower-Inner & Outer Kit Measure arm housing ID upon removal of OE rubber bushing, this kit suited to 38mm inside...	<b>MPU-2808K</b>	1	Washers, Inner Tubes, Bushings	
TRAS.	Control Arm Lower-Inner & Outer Kit Measure arm housing ID upon removal of OE rubber bushing, this kit suited to 34mm inside...	<b>MPU-1463K</b>	1	Washers, Inner Tubes, Bushings	
TRAS.	Cross-member Supplement Washers Race or Track only, possible NVH in street car.	<b>MPU-2701K</b>	1	Bushings	

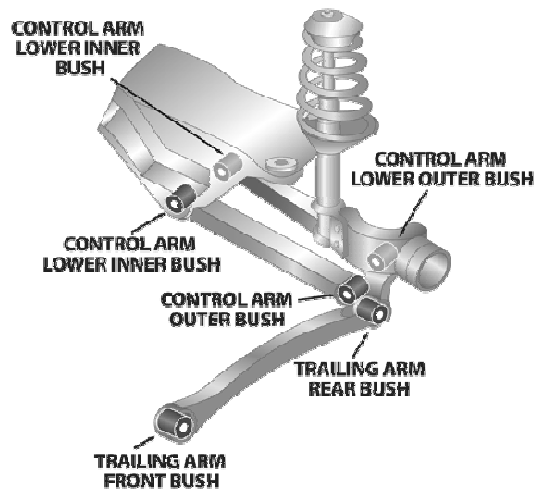
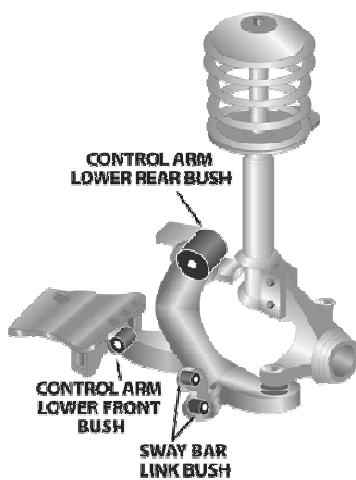

## SUBARU WRX Impreza, Sportswagon & Hatch GD STi - 2005 -...

Página 3 (Continúa)









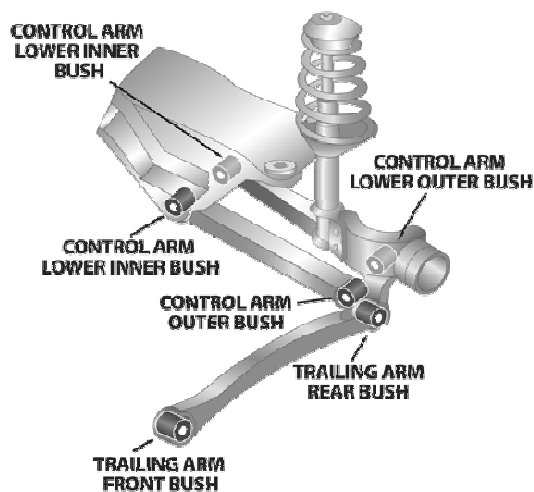

Aplicaci...	Descripción	Referencia	Kits por...	Contenido del Kit	
TRAS.	Differential Support Bracket Mount Kit Competition use recommended	<b>MPU-2433K</b>	1	Inner Tubes, Bushings	
TRAS.	Sway Bar Mount Bushing Measure bar diameter, 14,16,17,18,20,21,22,24mm available.	<b>MPU-2791-__K</b>	1	Bushings	
TRAS.	Trailing Arm Lower Front Bushing	<b>MPU-1491K</b>	1	Inner Tubes, Bushings	
TRAS.	Trailing Arm Lower Rear Bushing	<b>MPU-2810K</b>	1	Inner Tubes, Bushings	



## SUBARU WRX Impreza, Sportswagon & Hatch GH Sedan &...

Página 1



Aplicaci...	Descripción	Referencia	Kits por...	Contenido del Kit	
DEL.	Control Arm Lower-Inner Front Kit	<b>MPU-3091K</b>	1	Washers, Inner Tubes, Bushings	 SPF3091K
DEL.	Control Arm Lower-Inner Front Kit SUITS MY08 -MY10 (STi ALLOY ARMS ONLY)	<b>MPU-3728K</b>	1	Bushings, Inner Tubes	 SPF3728K
DEL.	Control Arm Lower-Inner Rear Eccentric 2 x Offset bushings, giving 0.75 degree castor change per side; Suits WRX & STi with 60mm...	<b>MPU-3094K</b>	1	Inst Sheet, Outer Shells, Inner Tubes, Bushings	
DEL.	Control Arm Lower-Inner Rear Eccentric 1 x Standard & 1 x Offset bushing, giving 0.75 degree castor change one side; Suits WRX &...	<b>MPU-3093K</b>	1	Inst Sheet, Outer Shells, Inner Tubes, Bushings	
DEL.	Control Arm Lower-Inner Rear Kit Standard replacement; Suits WRX & STi with 60mm OD Bushes.	<b>MPU-3092K</b>	1	Inst Sheet, Outer Shells, Inner Tubes, Bushings	
DEL.	Gearbox Cross Member Isolator Mount Re-use OE crush tubes, Replaces OE# 41022GA400	<b>MPU-3199K</b>	1	Inst Sheet, Bushings	 SPF3199K
DEL.	Steering Rack & Pinion Mount Bushing ** THIS KIT INCLUDES O.E BUSH REMOVAL TOOL **	<b>MPU-2889K</b>	1	Nuts, Rods, Washers, Outer Shells, Inner Tubes, Bushings	 SPF2889K



## SUBARU WRX Impreza, Sportswagon & Hatch GH Sedan &...

Página 2 (Continúa)

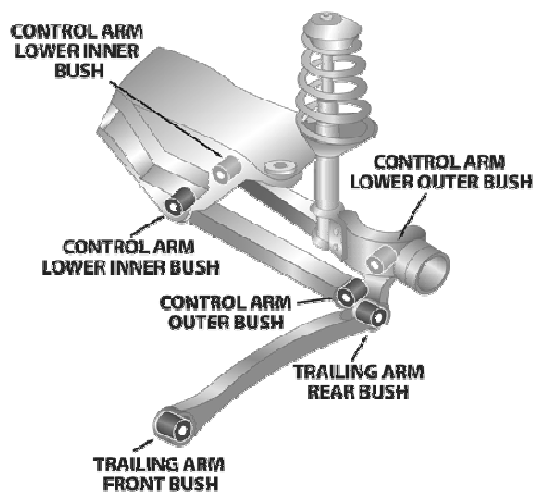

Aplicaci...	Descripción	Referencia	Kits por...	Contenido del Kit	
DEL.	Steering Rack & Pinion Mount Bushing ** DOES NOT INCLUDE REMOVAL TOOL **	<b>MPU-2889BK</b>	1	Inst Sheet, Inner Tubes, Bushings	
DEL.	Sway Bar Mount Bushing Measure bar diameter, 18,20,21,22,23,24,25mm available	<b>MPU-3096-__K</b>	1	Bushings	
TRAS.	Control Arm Lower-Inner Bushing Standard replacement	<b>MPU-3106K</b>	1	Inst Sheet, Inner Tubes, Bushings	
TRAS.	Control Arm Lower-Inner Eccentric Kit Offset tubes in kit for adjustment	<b>MPU-3107K</b>	1	Inst Sheet, Inner Tubes, Bushings	
TRAS.	Control Arm Lower-Outer Bushing Replaces Hyme joint in hub	<b>MPU-3104K</b>	1	Inst Sheet, Inner Tubes, Bushings	
TRAS.	Control Arm Upper-Inner Eccentric Kit Offset tubes for adjustment	<b>MPU-3101K</b>	1	Inst Sheet, Inner Tubes, Bushings	
TRAS.	Control Arm Upper-Inner Kit Standard replacement	<b>MPU-3100K</b>	1	Inst Sheet, Inner Tubes, Bushings	



## SUBARU WRX Impreza, Sportswagon & Hatch GH Sedan &...

Página 3 (Continúa)

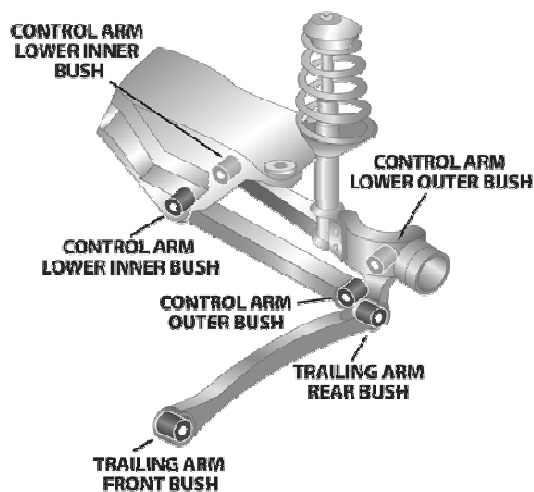





Aplicaci...	Descripción	Referencia	Kits por...	Contenido del Kit	
TRAS.	Crossmember Insert Enhancement Kit Use with OE rubber mounts 3202 - Lower side 3203 - Upper side	<b>MPU-3831K</b>	1	Bushings	
TRAS.	Differential Mount Bushing Replaces OE#41322FG000	<b>MPU-3201K</b>	1	Inst Sheet, Outer Shells, Inner Tubes, Bushings	
TRAS.	Differential Pinion, Bracket Mount Kit	<b>MPU-3200K</b>	1	Inner Tubes, Bushings	
TRAS.	Sway Bar Link Complete Rod.....OE Replacement	<b>MPU-3915K</b>	1	Link Rod, Inner Tubes, Bushings	
TRAS.	Sway Bar Link Lower Bushing Suited to original link rod, Note upper is ball joint style mount	<b>MPU-3109K</b>	1	Inner Tubes, Bushings	
TRAS.	Sway Bar Mount Bushing Measure bar diameter	<b>MPU-3108-__K</b>	1	Bushings	
TRAS.	Toe Control Arm - Inner Bushing Note, Outer bushing is ball joint style	<b>MPU-3099K</b>	1	Inner Tubes, Bushings	

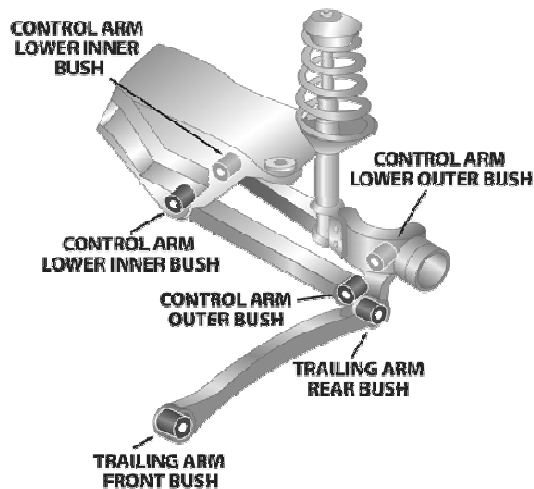

**SUBARU WRX Impreza, Sportswagon & Hatch GH Sedan &...**

Página 4 (Continúa)









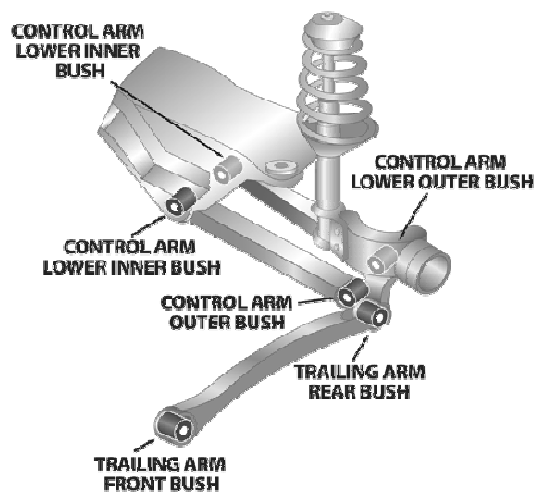
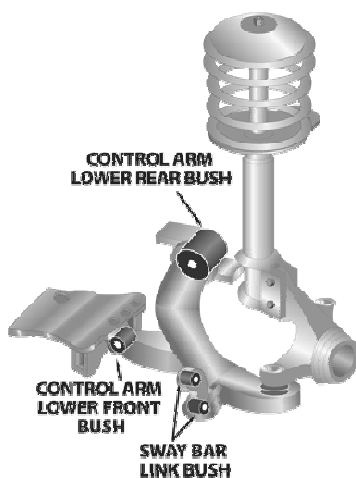

Aplicaci...	Descripción	Referencia	Kits por...	Contenido del Kit	
TRAS.	Trailing Arm - Front Bushing	<b>MPU-3097K</b>	1	Inst Sheet, Washers, Inner Tubes, Bushings	 SPF3097K
TRAS.	Trailing Arm - Rear Bushing	<b>MPU-3098K</b>	1	Inst Sheet, Inner Tubes, Bushings	 SPF3098K



## SUBARU WRX Impreza, Sportswagon & Hatch GC, GF and GM...

Página 1









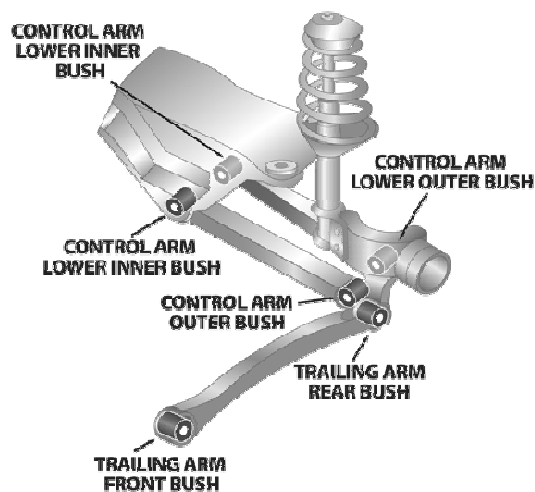
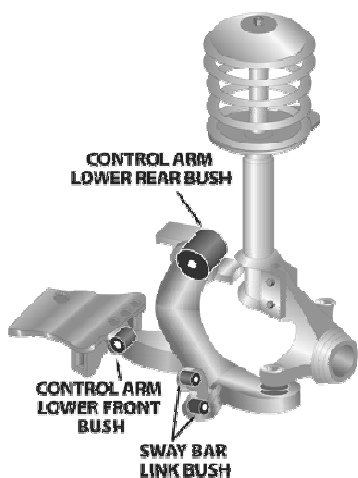

Aplicaci...	Descripción	Referencia	Kits por...	Contenido del Kit	
DEL.	Control Arm Lower-Inner Rear Eccentric Autocross Kit, Anti Lift, & Caster Increase both sides, 2 x offset bushings per kit.	<b>MPU-1388AK</b>	1	Washers, Outer Shells, Inner Tubes, Bushings	
DEL.	Control Arm Lower-Inner Rear Kit Standard	<b>MPU-1387K</b>	1	Outer Shells, Inner Tubes, Bushings	
DEL.	Control Arm Lower-Inner Rear Kit PS Standard DS Decrease, to provide caster spread	<b>MPU-1388K</b>	1	Outer Shells, Inner Tubes, Bushings	
DEL.	Control Arm-Inner Front Bushing Tube length 55mm	<b>MPU-1390K</b>	1	Washers, Inner Tubes, Bushings	
DEL.	Gear-linkage, Support Bar, Front Bush 5 Speed - Replaces original bushing 35035AC030, 44mm outside diameter bushing	<b>MPU-2704K</b>	1	Bushings	
DEL.	Gearbox Cross Member Isolator Mount	<b>MPU-2358K</b>	1	Bushings	
DEL.	Steering Rack & Pinion Mount Bushing 25mm Bracket width, passenger side	<b>MPU-1835K</b>	1	Bushings	



## SUBARU WRX Impreza, Sportswagon & Hatch GC, GF and GM...

Página 2 (Continúa)



Aplicaci...	Descripción	Referencia	Kits por...	Contenido del Kit	
DEL.	Steering Rack & Pinion Mount Bushing 30mm bracket width, passenger side	<b>MPU-1972K</b>	1	Bushings	
DEL.	Sway Bar Link Bushing Kit	<b>MPU-1384K</b>	1	Inner Tubes, Bushings	
DEL.	Sway Bar Mount To Chassis Bushing Measure bar diameter 13,14,15,16,17,18,19,20,21,22,23,24,25.4 &...	<b>MPU-1383-__K</b>	1	Bushings	
F & R	SuperPro Alignment Kit Front Suspension SPF1388AK X 1 & Rear Suspension 81260 x 1 (Camber Pins) in kit. See any notes listed...	<b>MPK-133K</b>	1	Pin, Washers, Outer Shells, Inner Tubes, Bushings	
F & R	SuperPro Enhancement Kit WRX	<b>MPK-134K</b>	1	Washers, Outer Shells, Inner Tubes, Bushings	
F & R	SuperPro Enhancement Kit STI = SPF1390Kx1, SPF1388AKx1, SPF1972Kx1, SPF1463Kx1, SPF1491Kx1, SPF1907Kx1. See notes against...	<b>MPK-135K</b>	1	Washers, Outer Shells, Inner Tubes, Bushings	
TRAS.	Control Arm Lower-Inner & Outer Kit Measure arm housing ID upon removal of OE rubber bushing, this kit suited to 34mm inside...	<b>MPU-1463K</b>	1	Washers, Inner Tubes, Bushings	





## SUBARU WRX Impreza, Sportswagon & Hatch GC, GF and GM...

Página 3 (Continúa)

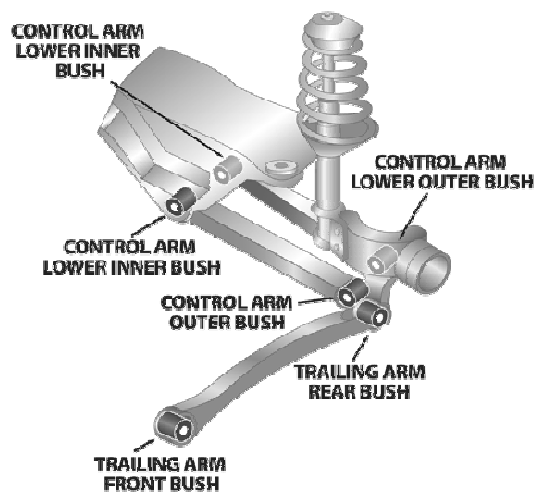
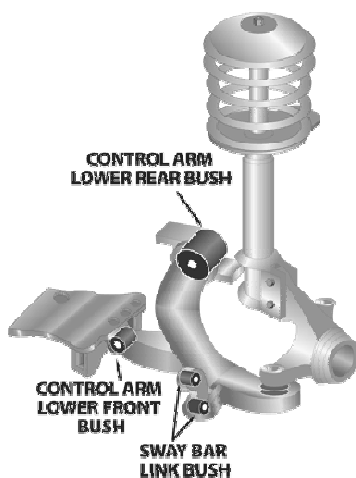

Aplicaci...	Descripción	Referencia	Kits por...	Contenido del Kit	
TRAS.	Cross-member Supplement Washers Anti tramp bushing	<b>MPU-1978K</b>	1	Bushings	
TRAS.	Differential Support Bracket Mount Kit	<b>MPU-2664K</b>	1	Washers, Inner Tubes, Bushings	
TRAS.	Sway Bar Link Bushing Kit	<b>MPU-1384AK</b>	1	Inner Tubes, Bushings	
TRAS.	Sway Bar Mount To Chassis Bushing Measure bar diameter 13,14,15,16,17,18,19,20,21,22,23,24,25.4 &...	<b>MPU-1383-__K</b>	1	Bushings	
TRAS.	Trailing Arm Lower Front Bushing	<b>MPU-1491K</b>	1	Inner Tubes, Bushings	
TRAS.	Trailing Arm Lower Rear Bushing	<b>MPU-1907K</b>	1	Inner Tubes, Bushings	



## SUBARU Forester AWD SG Wagon - 5/2002 - 2/2008

Página 1

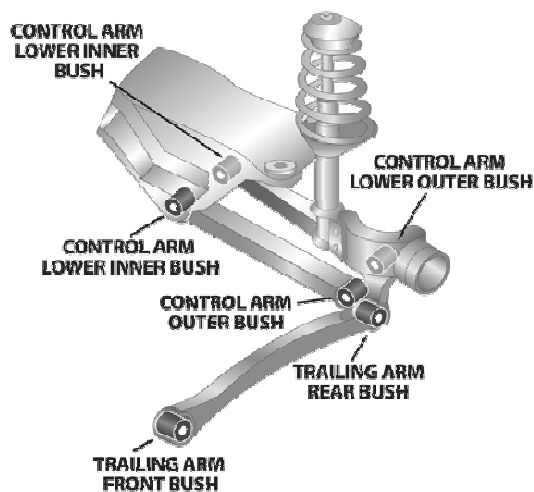







Aplicaci...	Descripción	Referencia	Kits por...	Contenido del Kit	
DEL.	Control Arm Lower-Inner Rear Eccentric Autocross Kit, Anti Lift, & Caster Increase both sides, 2 x offset bushings per kit.	<b>MPU-1388AK</b>	1	Washers, Outer Shells, Inner Tubes, Bushings	
DEL.	Control Arm Lower-Inner Rear Eccentric PS Standard DS Decrease, to provide caster spread	<b>MPU-1388K</b>	1	Outer Shells, Inner Tubes, Bushings	
DEL.	Control Arm Lower-Inner Rear Kit Standard replacement	<b>MPU-1387K</b>	1	Outer Shells, Inner Tubes, Bushings	
DEL.	Spring Insulator Pad Bushing Upper spring seat bushing	<b>MPU-2994K</b>	1	Bushings	
DEL.	Steering Rack & Pinion Mount Bushing 25mm Bracket width, passenger side	<b>MPU-1835K</b>	1	Bushings	
DEL.	Steering Rack & Pinion Mount Bushing 30mm bracket width, passenger side	<b>MPU-1972K</b>	1	Bushings	
DEL.	Sway Bar Mount To Chassis Bushing Bar diameters 17,18,19,20,21,22,23,24,25.4 and 27mm available	<b>MPU-1617-__K</b>	1	Bushings	

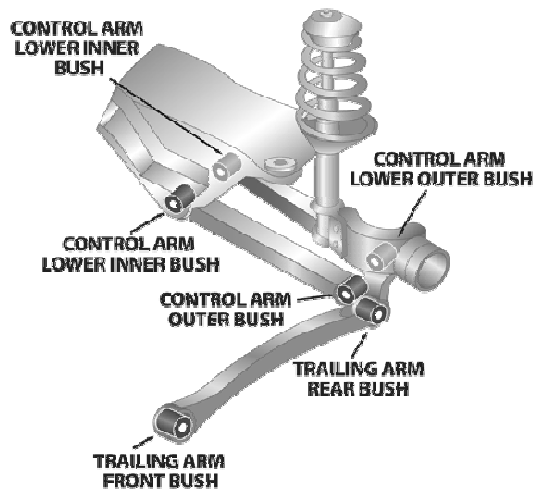

## SUBARU Forester AWD SG Wagon - 5/2002 - 2/2008

Página 2 (Continúa)









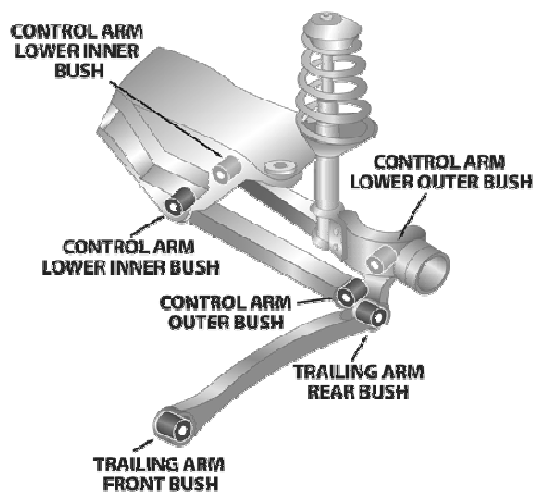

Aplicaci...	Descripción	Referencia	Kits por...	Contenido del Kit	
TRAS.	Control Arm Lower-Inner & Outer Kit Measure arm housing ID upon removal of OE rubber bushing, this kit suited to 34mm inside...	<b>MPU-1463K</b>	1	Washers, Inner Tubes, Bushings	
TRAS.	Differential Support Bracket Mount Kit	<b>MPU-2664K</b>	1	Washers, Inner Tubes, Bushings	
TRAS.	Sway Bar Mount To Chassis Bushing Bar diameters 13,14,15,16,17,18,19,20,21,22,23,24,25.4...	<b>MPU-1383-__K</b>	1	Bushings	
TRAS.	Trailing Arm Lower Front Bushing	<b>MPU-1491K</b>	1	Inner Tubes, Bushings	
TRAS.	Trailing Arm Lower Rear Bushing	<b>MPU-1907K</b>	1	Inner Tubes, Bushings	



## SUBARU Forester AWD SH Wagon - 6/2008 - Current

Página 1



Aplicaci...	Descripción	Referencia	Kits por...	Contenido del Kit	
DEL.	Control Arm Lower-Inner Front Kit	<b>MPU-3091K</b>	1	Washers, Inner Tubes, Bushings	 SPF3091K
DEL.	Control Arm Lower-Inner Rear Eccentric 1 x Standard & 1 x Offset bushing	<b>MPU-3379K</b>	1	Inst Sheet, Outer Shells, Inner Tubes, Bushings	
DEL.	Control Arm Lower-Inner Rear Eccentric 2 x Offset bushing, .75 degree castor change.	<b>MPU-3380K</b>	1	Inst Sheet, Outer Shells, Inner Tubes, Bushings	
DEL.	Control Arm Lower-Inner Rear Eccentric	<b>MPU-3094K</b>	1	Inst Sheet, Outer Shells, Inner Tubes, Bushings	
DEL.	Control Arm Lower-Inner Rear Kit Standard replacement	<b>MPU-3378K</b>	1	Inst Sheet, Outer Shells, Inner Tubes, Bushings	
DEL.	Steering Rack & Pinion Mount Bush.....Power Steering ** THIS KIT INCLUDES O.E BUSH REMOVAL TOOL **	<b>MPU-2889K</b>	1	Nuts, Rods, Washers, Outer Shells, Inner Tubes, Bushings	 SPF2889K
DEL.	Steering Rack & Pinion Mount Bushing ** DOES NOT INCLUDE REMOVAL TOOL **	<b>MPU-2889BK</b>	1	Inst Sheet, Inner Tubes, Bushings	 SPF2889BK



## SUBARU Forester AWD SH Wagon - 6/2008 - Current

Página 2 (Continúa)

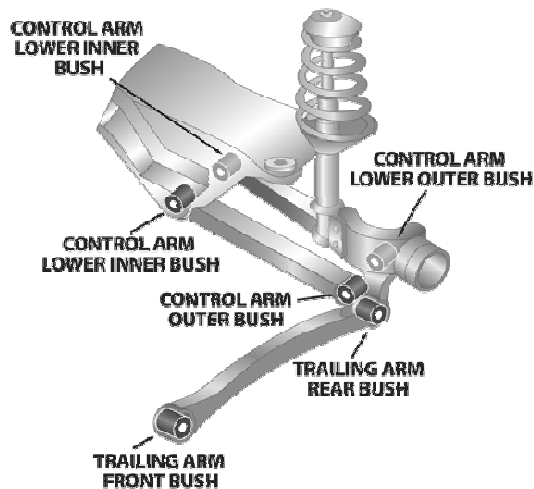

Aplicaci...	Descripción	Referencia	Kits por...	Contenido del Kit	
DEL.	Sway Bar Mount Bushing Measure bar diameter, 14,16,17,18,20,21,22,24mm available.	MPU-2791-__K	1	Bushings	
DEL.	Sway Bar Mount Bushing Bar diameters 18,20,21,22,23,24,25mm available	MPU-3096-__K	1	Bushings	
TRAS.	Control Arm Lower-Inner Bushing Standard replacement	MPU-3106K	1	Inst Sheet, Inner Tubes, Bushings	
TRAS.	Control Arm Lower-Inner Eccentric Kit Offset tubes in kit for adjustment	MPU-3107K	1	Inst Sheet, Inner Tubes, Bushings	
TRAS.	Control Arm Lower-Outer Bushing Replaces Hyme joint in hub	MPU-3104K	1	Inst Sheet, Inner Tubes, Bushings	
TRAS.	Control Arm Upper-Inner Eccentric Kit Offset tubes for adjustment	MPU-3101K	1	Inst Sheet, Inner Tubes, Bushings	
TRAS.	Control Arm Upper-Inner Kit Standard replacement	MPU-3100K	1	Inst Sheet, Inner Tubes, Bushings	



## SUBARU Forester AWD SH Wagon - 6/2008 - Current

Página 3 (Continúa)

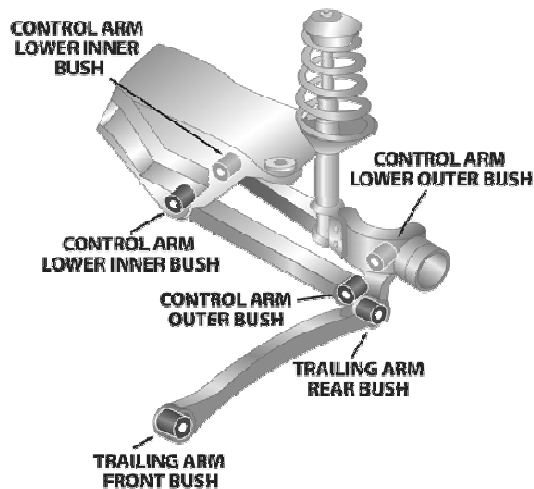

Aplicaci...	Descripción	Referencia	Kits por...	Contenido del Kit	
TRAS.	Crossmember Insert Enhancement Kit Use with OE rubber mounts 3202 - Lower side 3203 - Upper side	<b>MPU-3831K</b>	1	Bushings	
TRAS.	Differential Pinion, Bracket Mount Kit	<b>MPU-3200K</b>	1	Inner Tubes, Bushings	
TRAS.	Gearbox Cross Member Isolator Mount Re-use OE crush tubes, Replaces OE# 41022GA400	<b>MPU-3199K</b>	1	Inst Sheet, Bushings	
TRAS.	Subframe To Chassis Void Fillers Top side of mount, Bore size 46mm to be used with original rubber bushing	<b>MPU-3381K</b>	1	Inst Sheet, Bushings	
TRAS.	Sway Bar Link Complete Rod.....OE Replacement	<b>MPU-3915K</b>	1	Link Rod, Inner Tubes, Bushings	
TRAS.	Sway Bar Link Lower Bushing Suited to original link rod, Note upper is ball joint style mount	<b>MPU-3109K</b>	1	Inner Tubes, Bushings	
TRAS.	Sway Bar Mount Bushing Measure bar diameter	<b>MPU-3108-__K</b>	1	Bushings	



## SUBARU Forester AWD SH Wagon - 6/2008 - Current

Página 4 (Continúa)

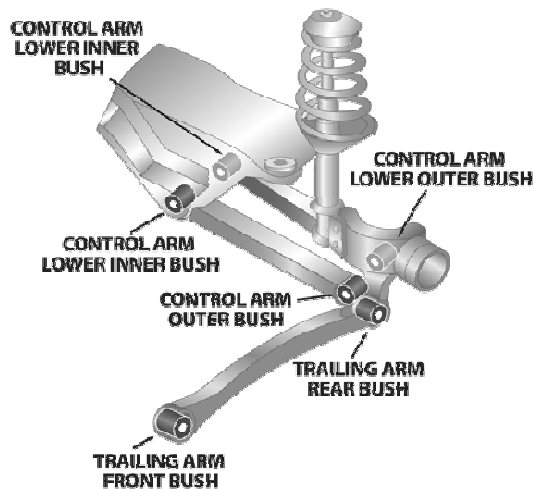

Aplicaci...	Descripción	Referencia	Kits por...	Contenido del Kit	
TRAS.	Toe Control Arm - Inner Bushing Note, Outer bushing is ball joint style	<b>MPU-3099K</b>	1	Inner Tubes, Bushings	
TRAS.	Trailing Arm - Front Bushing	<b>MPU-3097K</b>	1	Inst Sheet, Washers, Inner Tubes, Bushings	
TRAS.	Trailing Arm - Rear Bushing	<b>MPU-3098K</b>	1	Inst Sheet, Inner Tubes, Bushings	



**SUBARU Forester AWD SF Wagon - 8/1997 - 6/2002**

Página 1

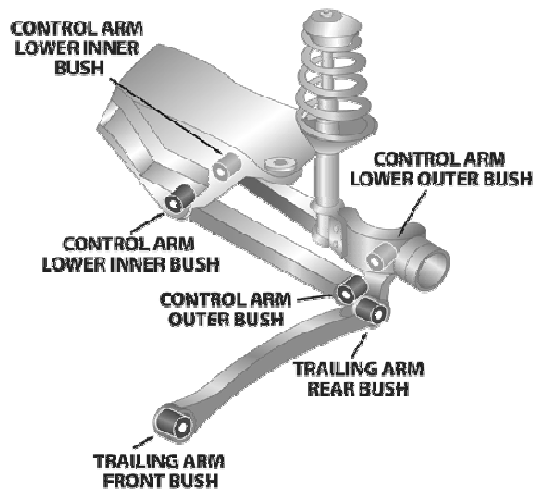
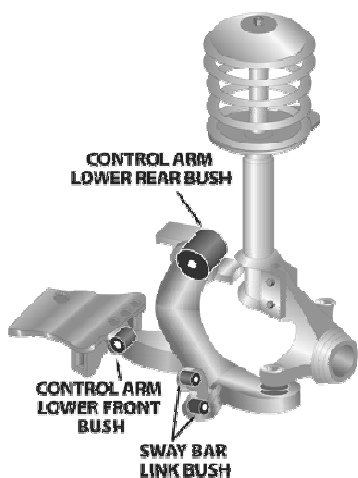

Aplicaci...	Descripción	Referencia	Kits por...	Contenido del Kit	
DEL.	Control Arm Lower-Front Bushing Tube length 55mm	<b>MPU-1390K</b>	1	Washers, Inner Tubes, Bushings	
DEL.	Control Arm Lower-Inner Rear Eccentric Autocross Kit, Anti Lift, & Caster Increase both sides, 2 x offset bushings per kit.	<b>MPU-1388AK</b>	1	Washers, Outer Shells, Inner Tubes, Bushings	
DEL.	Control Arm Lower-Inner Rear Kit Standard replacement	<b>MPU-1387K</b>	1	Outer Shells, Inner Tubes, Bushings	
DEL.	Control Arm Lower-Inner Rear Kit PS Standard DS Decrease, to provide caster spread	<b>MPU-1388K</b>	1	Outer Shells, Inner Tubes, Bushings	
DEL.	Steering Rack & Pinion Mount Bushing 25mm Bracket width, passenger side	<b>MPU-1835K</b>	1	Bushings	
DEL.	Steering Rack & Pinion Mount Bushing 30mm bracket width, passenger side	<b>MPU-1972K</b>	1	Bushings	
DEL.	Sway Bar Link Bushing Kit 2 x large bushings & 2 x small bushings	<b>MPU-1200K</b>	1	Inner Tubes, Bushings	









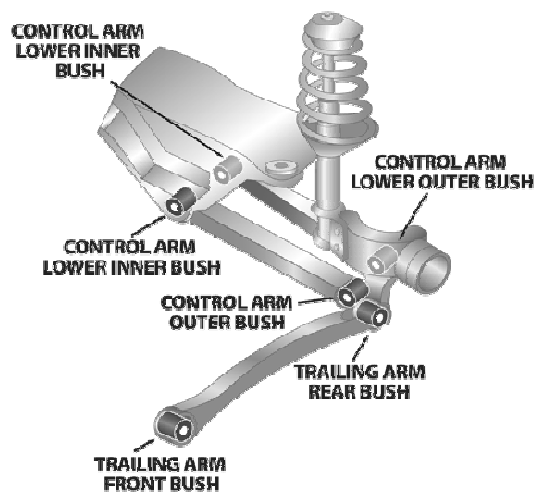
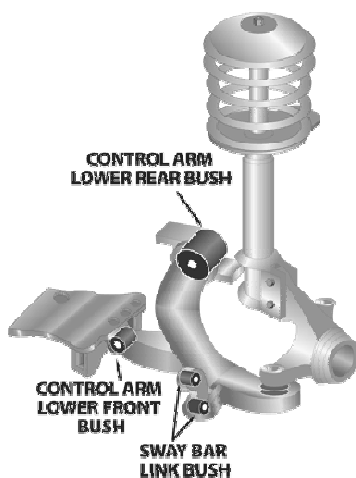



## SUBARU Forester AWD SF Wagon - 8/1997 - 6/2002

Página 2 (Continúa)





Aplicaci...	Descripción	Referencia	Kits por...	Contenido del Kit	
DEL.	Sway Bar Mount To Chassis Bushing Bar diameters 17,18,19,20,21,22,23,24,25.4 and 27mm available	MPU-1617-__K	1	Bushings	
TRAS.	Control Arm Lower-Inner & Outer Kit Measure arm housing ID upon removal of OE rubber bushing, this kit suited to 34mm inside...	MPU-1463K	1	Washers, Inner Tubes, Bushings	
TRAS.	Cross-member Supplement Washers Anti tramp bushing	MPU-1978K	1	Bushings	
TRAS.	Differential Support Bracket Mount Kit	MPU-2664K	1	Washers, Inner Tubes, Bushings	
TRAS.	Sway Bar Link Bushing Kit	MPU-1384AK	1	Inner Tubes, Bushings	
TRAS.	Sway Bar Mount To Chassis Bushing Measure bar diameter 13,14,15,16,17,18,19,20,21,22,23,24,25.4 &...	MPU-1383-__K	1	Bushings	
TRAS.	Trailing Arm Lower Front Bushing	MPU-1491K	1	Inner Tubes, Bushings	

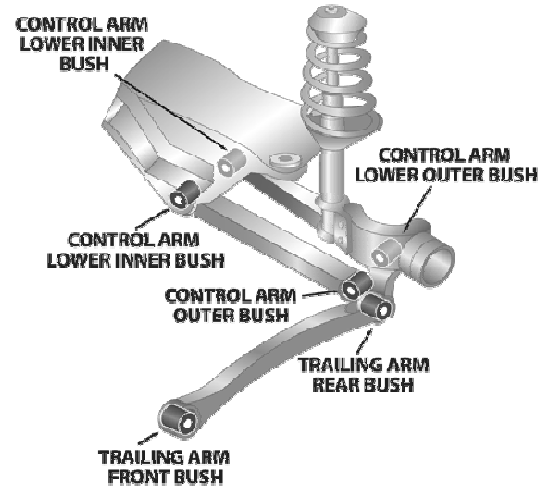
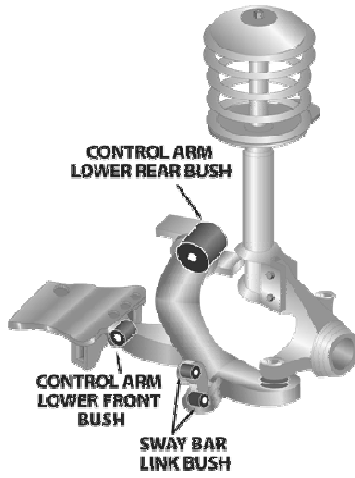

**SUBARU Forester AWD SF Wagon - 8/1997 - 6/2002**

Página 3 (Continúa)





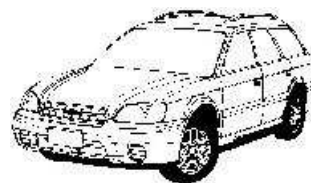



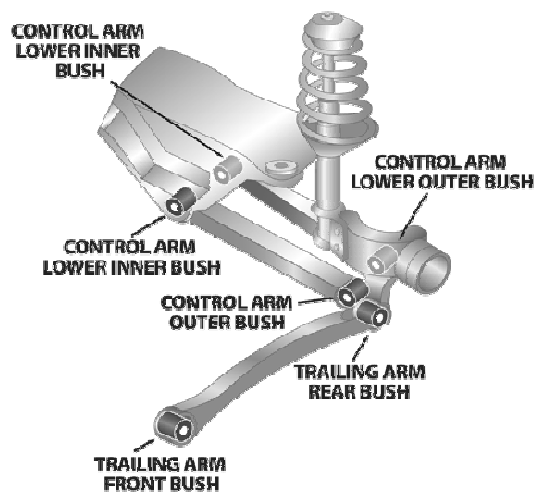
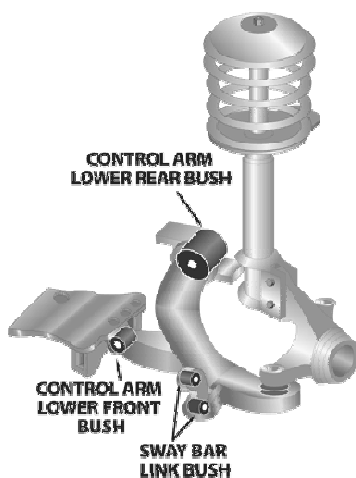

Aplicaci...	Descripción	Referencia	Kits por...	Contenido del Kit	
TRAS.	Trailing Arm Lower Rear Bushing	<b>MPU-1907K</b>	1	Inner Tubes, Bushings	



## SUBARU Outback BH Wagon 4WD 3rd Generation - 12/1997 - ...

Página 1





Aplicaci...	Descripción	Referencia	Kits por...	Contenido del Kit	
DEL.	Control Arm Lower-Inner Rear Eccentric Autocross Kit, Anti Lift, & Caster Increase both sides, 2 x offset bushings per kit.	<b>MPU-1388AK</b>	1	Washers, Outer Shells, Inner Tubes, Bushings	
DEL.	Control Arm Lower-Inner Rear Kit Standard	<b>MPU-1387K</b>	1	Outer Shells, Inner Tubes, Bushings	
DEL.	Control Arm Lower-Inner Rear Kit PS Standard DS Decrease, to provide caster spread	<b>MPU-1388K</b>	1	Outer Shells, Inner Tubes, Bushings	
DEL.	Steering Rack & Pinion Mount Bushing	<b>MPU-2580K</b>	1	Bushings	
DEL.	Sway Bar Link Bushing Kit	<b>MPU-1384K</b>	1	Inner Tubes, Bushings	
DEL.	Sway Bar Mount To Chassis Bushing Measure bar diameter 17,18,19,20,21,22,23,24,25.4 & 27mm available	<b>MPU-1617-__K</b>	1	Bushings	
TRAS.	Differential Mount Bushing Replaces OE#41322FG000	<b>MPU-3201K</b>	1	Inst Sheet, Outer Shells, Inner Tubes, Bushings	

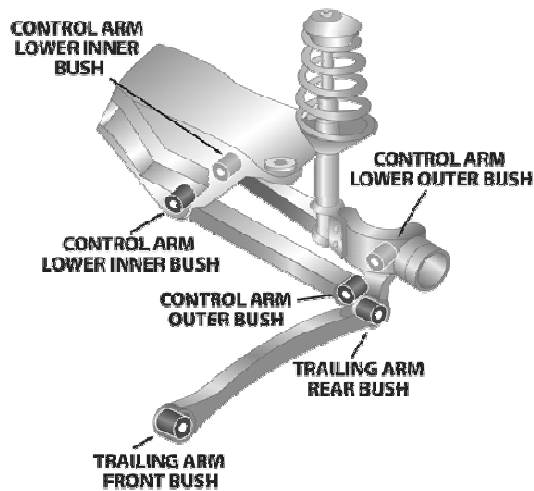
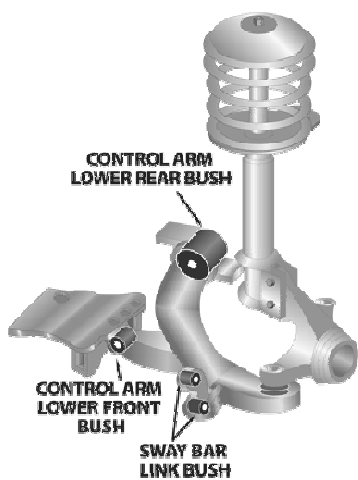

**SUBARU Outback BH Wagon 4WD 3rd Generation - 12/1997 - ...**

Página 2 (Continúa)









Aplicaci...	Descripción	Referencia	Kits por...	Contenido del Kit	
TRAS.	Sway Bar Link Bushing Kit	MPU-1384AK	1	Inner Tubes, Bushings	

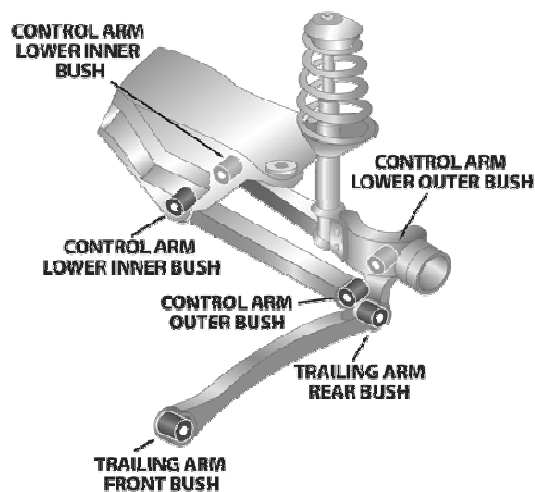

SUBARU Outback BP Wagon 4WD 4th Generation - 9/2003 -...

Página 1





Aplicaci...	Descripción	Referencia	Kits por...	Contenido del Kit	
DEL.	Control Arm Lower-Inner Rear Eccentric 1 x Standard & 1 x Offset bushing	<b>MPU-3379K</b>	1	Inst Sheet, Outer Shells, Inner Tubes, Bushings	
DEL.	Control Arm Lower-Inner Rear Eccentric 2 x Offset bushing, .75 degree castor change.	<b>MPU-3380K</b>	1	Inst Sheet, Outer Shells, Inner Tubes, Bushings	
DEL.	Control Arm Lower-Inner Rear Eccentric	<b>MPU-3094K</b>	1	Inst Sheet, Outer Shells, Inner Tubes, Bushings	
DEL.	Control Arm Lower-Inner Rear Kit Standard Replacement	<b>MPU-3378K</b>	1	Inst Sheet, Outer Shells, Inner Tubes, Bushings	

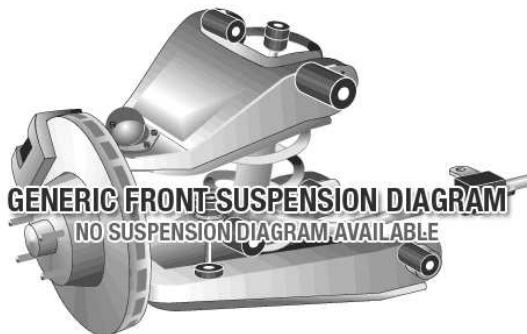
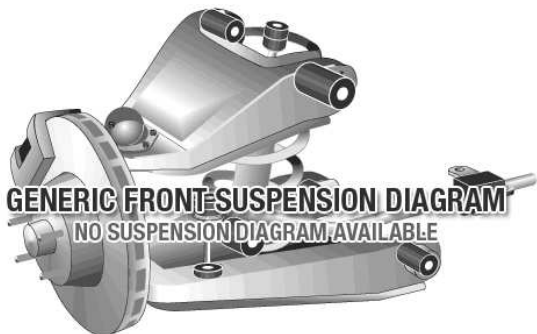

**SUBARU Brumby 4x4 - 1984 - 1994**

Página 1



Aplicaci...	Descripción	Referencia	Kits por...	Contenido del Kit	
TRAS.	Differential Pinion Mount Bushing	<b>MPU-3005K</b>	2	Inner Tubes, Bushings	



**SUBARU BRZ 2012 - ON -**

Página 1

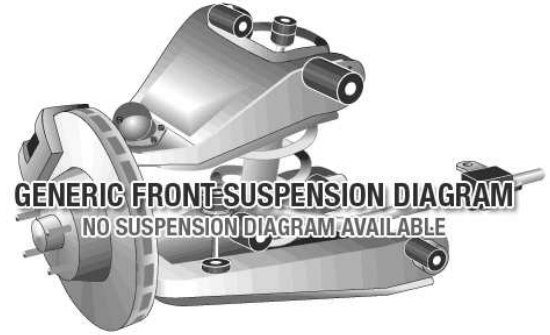







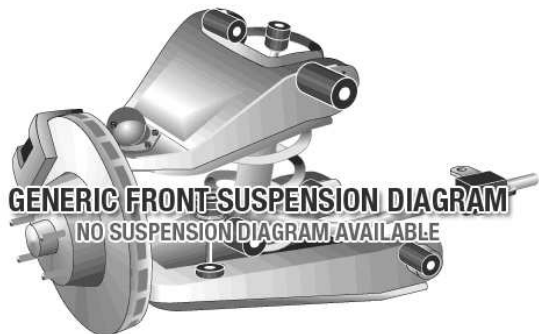

Aplicaci...	Descripción	Referencia	Kits por...	Contenido del Kit	
DEL.	Control Arm Lower-Inner Front & Rear THIS KIT FITS BOTH FRONT & REAR OF THE FRONT LOWER CONTROL ARM	<b>MPU-3877K</b>	1	Outer Shells, Inner Tubes, Bushings	
DEL.	Steering Rack & Pinion Mount Bushing	<b>MPU-3914K</b>	1	Inner Tubes, Bushings	
DEL.	Sway Bar Mount To Chassis Bushing Available sizes	<b>MPU-3868-__K</b>	1	Bushings	
F & R	Vehicle Master Kit CONTENTS - SPF3877K x 1,SPF3914K x 1,SPF3106K x 1,SPF3100K x 1,SPF3907K x 1,SPF3099K x 1,SPF3817K x...	<b>MPK-174K</b>	1	Outer Shells, Inner Tubes, Bushings	
TRAS.	Control Arm Lower-Inner Bushing Standard replacement	<b>MPU-3106K</b>	1	Inst Sheet, Inner Tubes, Bushings	
TRAS.	Control Arm Upper-Inner Eccentric Kit Offset tubes for adjustment	<b>MPU-3101K</b>	1	Inst Sheet, Inner Tubes, Bushings	
TRAS.	Control Arm Upper-Inner Kit Standard replacement	<b>MPU-3100K</b>	1	Inst Sheet, Inner Tubes, Bushings	



**SUBARU BRZ 2012 - ON -**

Página 2 (Continúa)



Aplicaci...	Descripción	Referencia	Kits por...	Contenido del Kit	
TRAS.	Crossmember Insert Enhancement Kit INCLUDES UPPER & LOWER INSERTS	<b>MPU-3907K</b>	1	Bushings	
TRAS.	Differential to Subframe Mount Kit Road Use.	<b>MPU-4112-80K</b>	1	Inner Tubes, Bushings, Inst Sheet	
TRAS.	Differential to Subframe Mount Kit Competition use.	<b>MPU-4112-90K</b>	1	Inst Sheet, Inner Tubes, Bushings	
TRAS.	Subframe to Chassis Mount Bush Kit	<b>MPU-3818K</b>	1	Washers, Inner Tubes, Bushings	
TRAS.	Sway Bar Link Complete Rod.....OE Replacement	<b>MPU-3915K</b>	1	Link Rod, Inner Tubes, Bushings	
TRAS.	Sway Bar Mount Bushing Measure bar diameter	<b>MPU-3108-__K</b>	1	Bushings	
TRAS.	Toe Control Arm - Inner Bushing	<b>MPU-3099K</b>	1	Inner Tubes, Bushings	





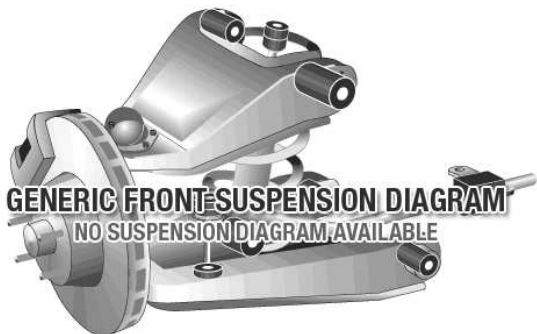

**SUBARU BRZ 2012 - ON -**

Página 3 (Continúa)



Aplicaci...	Descripción	Referencia	Kits por...	Contenido del Kit	
TRAS.	Trailing Arm - Front Bushing	<b>MPU-3817K</b>	1	Inner Tubes, Bushings	
TRAS.	Trailing Arm - Rear Bushing	<b>MPU-3098K</b>	1	Inst Sheet, Inner Tubes, Bushings	



## SUZUKI Swift ZC21 / ZC31 (2nd & 3rd Gen.) - 2005 - 2012

Página 1

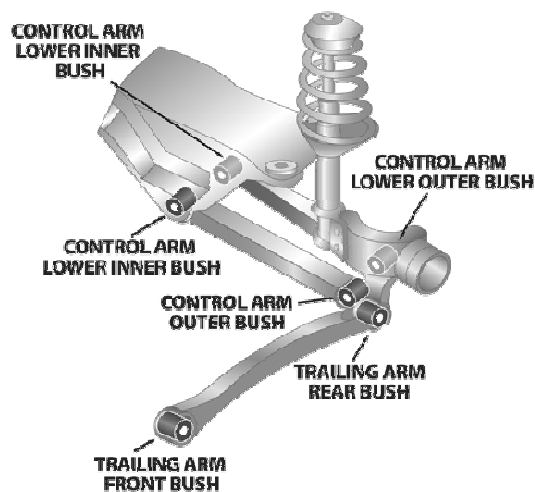
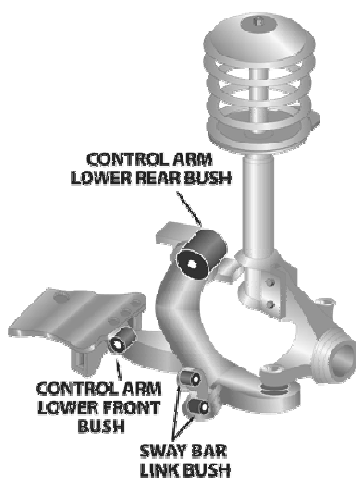

Aplicaci...	Descripción	Referencia	Kits por...	Contenido del Kit	
DEL.	Control Arm Lower-Inner Front Kit Replaces OE#45530-63500	<b>MPU-3169K</b>	1	Inner Tubes, Bushings	
DEL.	Control Arm Lower-Inner Rear Eccentric 1 x Standard bushing & 1 x Offset bushing, Aprox 0.4 degree castor change	<b>MPU-3171K</b>	1	Inst Sheet, Outer Shells, Inner Tubes, Bushings	
DEL.	Control Arm Lower-Inner Rear Eccentric 2 x Offset bushings, aprox 0.8 degree castor change	<b>MPU-3172K</b>	1	Inst Sheet, Outer Shells, Inner Tubes, Bushings	
DEL.	Control Arm Lower-Inner Rear Kit Standard replacement, replaces OE# 45540-63J00	<b>MPU-3170K</b>	1	Inst Sheet, Outer Shells, Inner Tubes, Bushings	
DEL.	Steering Rack & Pinion Mount Bush.....Power Steering	<b>MPU-2799K</b>	1	Bushings, Inner Tubes	
DEL.	Sway Bar Mount Bushing Measure bar diameter, 21,22,24,25mm currently available	<b>MPU-2783-__K</b>	1	Bushings	
F & R	Vehicle Master Kit CONTENTS - SPF3169K x 1,SPF3172K x 1,SPF3662K x 1	<b>MPK-178K</b>	1	Bushings, Inner Tubes, Outer Shells	



**SUZUKI Swift ZC21 / ZC31 (2nd & 3rd Gen.) - 2005 - 2012**

Página 2 (Continúa)

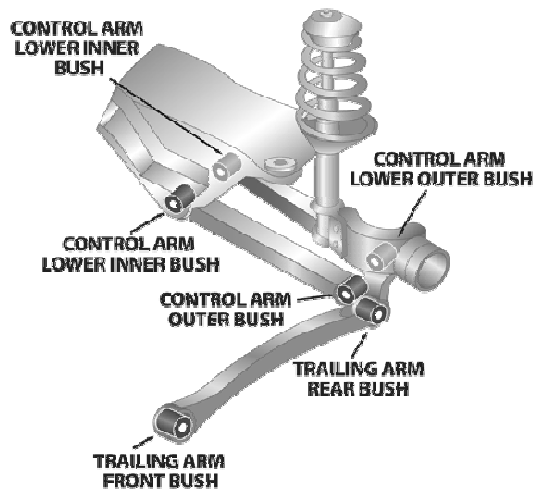
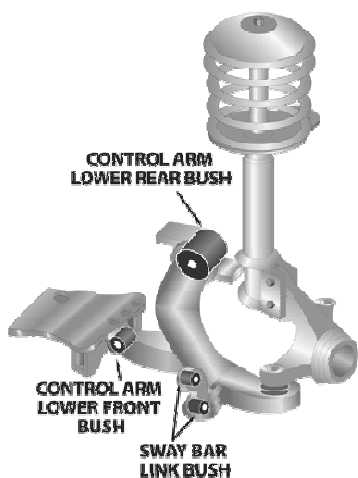







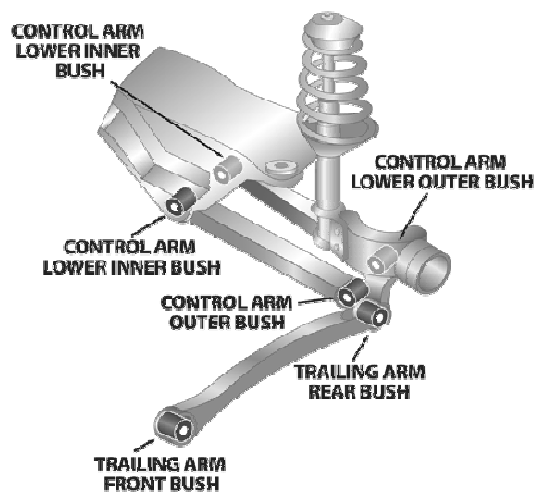
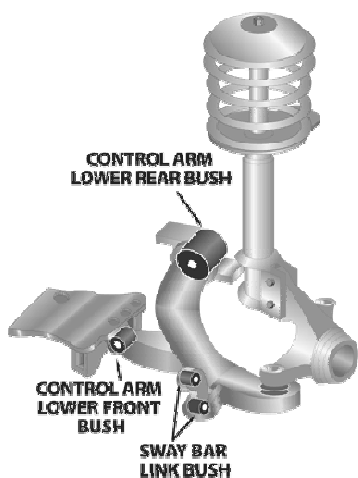

Aplicaci...	Descripción	Referencia	Kits por...	Contenido del Kit	
TRAS.	Beam Axle Pivot Bushing	MPU-3662K	1	Bushings, Inner Tubes	



## SUZUKI Swift GA, GL, GC & GTI Twin Cam - 2/1985 - 12/1988

Página 1









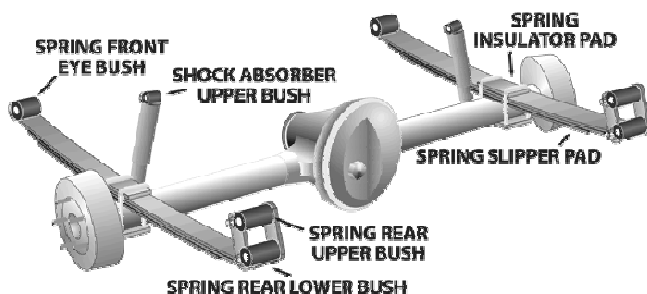
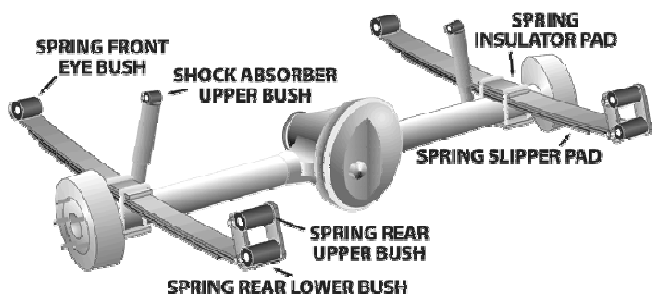

Aplicaci...	Descripción	Referencia	Kits por...	Contenido del Kit	
DEL.	Control Arm-Inner Bushing	<b>MPU-1203K</b>	1	Inner Tubes, Bushings	
DEL.	Steering Rack & Pinion Mount Bush....Manual Steering	<b>MPU-0223K</b>	1	Bushings	
DEL.	Sway Bar Mount To Chassis Bushing Measure bar diameter 21.5,24mm available	<b>MPU-0165-__K</b>	1	Bushings	
DEL.	Sway Bar To Lower Control Arm Kit	<b>MPU-0222K</b>	1	Bushings	
TRAS.	Spring Front Eye Bushing GC, GL	<b>MPU-0176K</b>	1	Bushings, Inner Tubes	
TRAS.	Spring Rear Bushing All GC, GL	<b>MPU-0173K</b>	1	Bushings	
TRAS.	Sway Bar Link Bushing Kit GA	<b>MPU-2092BK</b>	1	Bushings	



SUZUKI Sierra 4WD LJ50, 50V, 80, 80V, 81 - 1974 - 1981

Página 1







Aplicaci...	Descripción	Referencia	Kits por...	Contenido del Kit	
DEL.	Shock Absorber Lower Bushing	MPU-2178-16K	1	Bushings	
DEL.	Shock Absorber Upper Bushing	MPU-2755SK	1	Bushings	
DEL.	Spring Front Bushing All	MPU-0173K	1	Bushings	
DEL.	Spring Rear Eye Bushing	MPU-0176K	1	Bushings, Inner Tubes	
TRAS.	Shock Absorber Lower Bushing	MPU-2178-16K	1	Bushings	
TRAS.	Shock Absorber Upper Bushing LJ50 , LJ50V	MPU-2178-16K	1	Bushings	
TRAS.	Shock Absorber Upper Bushing LJ80 , LJ81	MPU-2755SK	1	Bushings	

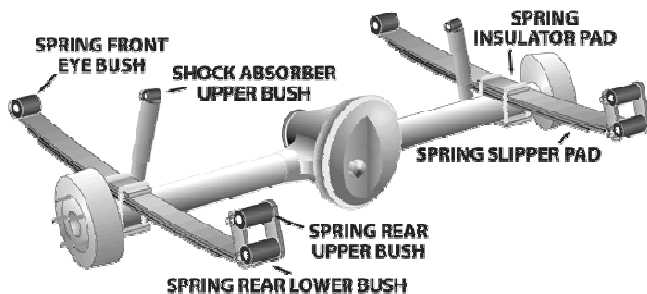
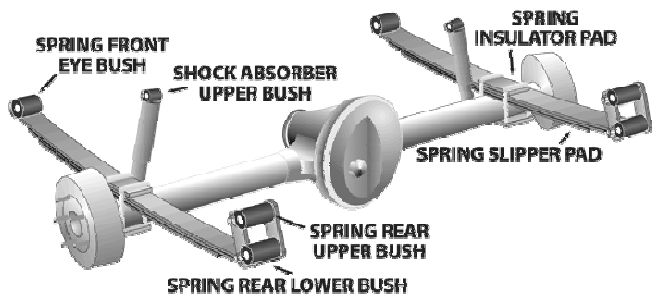

**SUZUKI Sierra 4WD LJ50, 50V, 80, 80V, 81 - 1974 - 1981**

Página 2 (Continúa)







Aplicaci...	Descripción	Referencia	Kits por...	Contenido del Kit	
TRAS.	Spring Front Eye Bushing	<b>MPU-0176K</b>	1	Bushings, Inner Tubes	 <b>0176K</b>
TRAS.	Spring Rear Bushing All	<b>MPU-0173K</b>	1	Bushings	 <b>0173K</b>

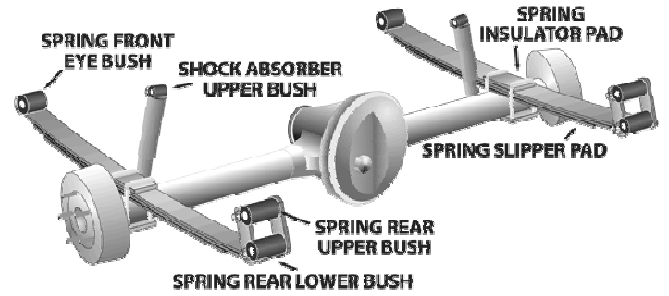
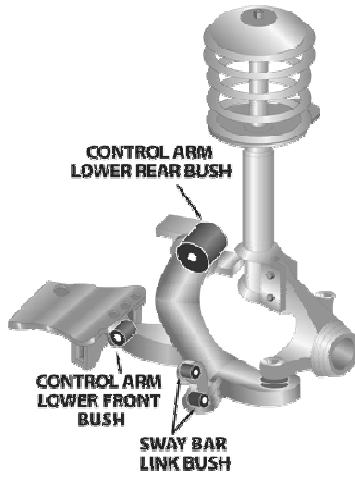

SUZUKI Carry Van ST80, ST90 - 6/1978 - 6/1985

Página 1





Aplicaci...	Descripción	Referencia	Kits por...	Contenido del Kit	
TRAS.	Spring Front Eye Bushing	MPU-0176K	1	Bushings, Inner Tubes	 0176K
TRAS.	Spring Rear Bushing All	MPU-0173K	1	Bushings	 0173K

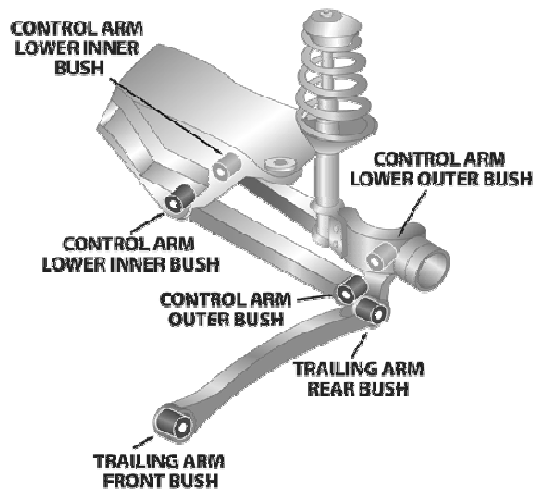
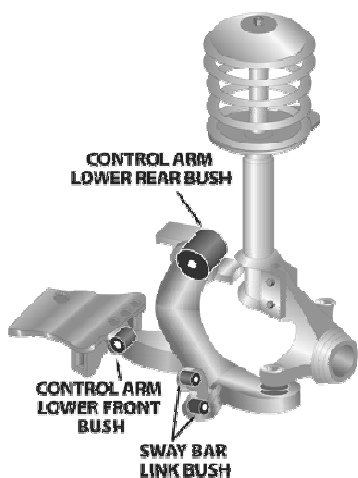

**SUZUKI Ignis Sedan - 11-2000 - 2004**

Página 1



Aplicaci...	Descripción	Referencia	Kits por...	Contenido del Kit	
DEL.	Sway Bar Mount Bushing Measure bar diameter 22,24mm available	MPU-2652-__K	1	Bushings	





SUZUKI X 90 2 Door 4WD - 4/1996 - 6/1998

Página 1

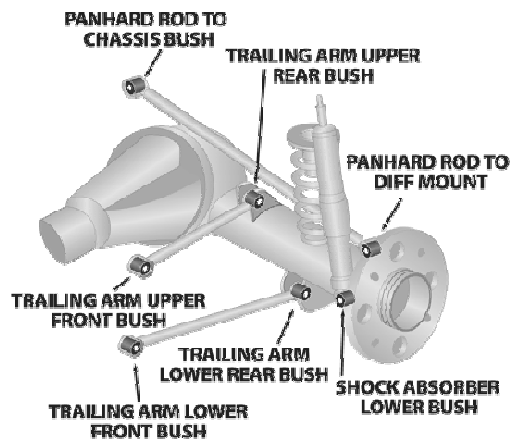
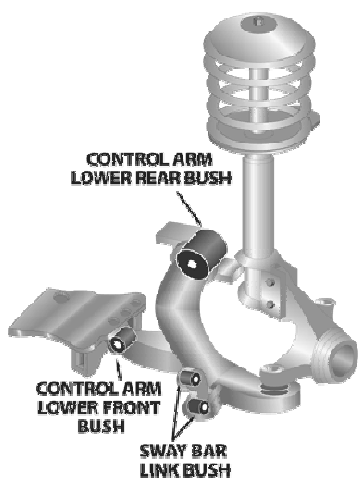



Aplicaci...	Descripción	Referencia	Kits por...	Contenido del Kit	
DEL.	Control Arm Lower Rear Bushing Adjustable caster kit	MPU-0920AK	1	Inner Tubes, Bushings	
DEL.	Control Arm Lower Rear Bushing	MPU-0920K	1	Bushings, Inner Tubes	
DEL.	Control Arm Lower-Front Bushing	MPU-0924K	1	Inner Tubes, Bushings	
DEL.	Sway Bar Link Lower Bushing	MPU-2092BK	1	Bushings	
DEL.	Sway Bar Mount To Chassis Bushing Measure bar diameter 25mm available	MPU-0923-__K	1	Bushings	
TRAS.	Control Arm Upper-Inner Kit	MPU-0921K	1	Inner Tubes, Bushings	
TRAS.	Trailing Arm Lower Bushing All	MPU-0922K	1	Inner Tubes, Bushings	

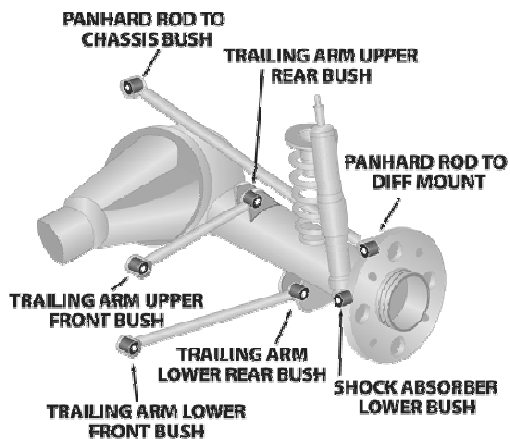
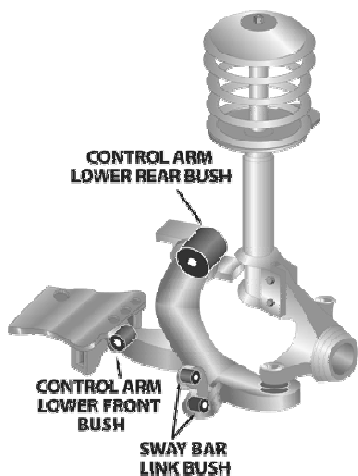

**SUZUKI Vitara Grand Wagon - 04/1998 - 2004**

Página 1



Aplicaci...	Descripción	Referencia	Kits por...	Contenido del Kit	
DEL.	Sway Bar Mount Bushing Measure bar diameter, 22,24 & 25.4mm available	MPU-1538-__K	1	Bushings	



SUZUKI Vitara Grand Wagon, JB Series - 8/2005 - 2009

Página 1

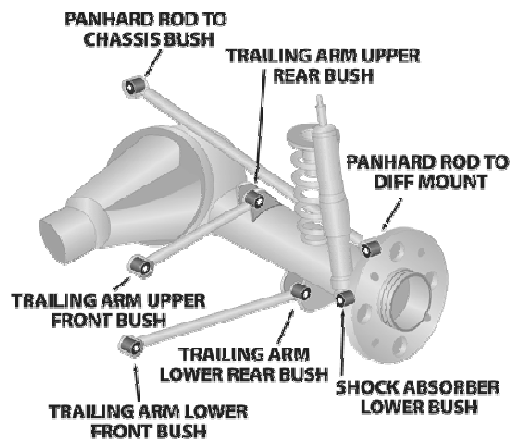
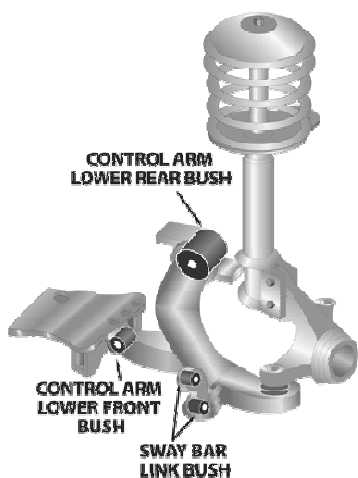

Aplicaci...	Descripción	Referencia	Kits por...	Contenido del Kit	
DEL.	Control Arm Lower-Inner Rear Eccentric 1 x Standard & 1 x offset bushing	<b>MPU-3385K</b>	1	Bushings, Outer Shells, Inner Tubes, Inst Sheet	
DEL.	Control Arm Lower-Inner Rear Eccentric 2 x Offset bushings	<b>MPU-3386K</b>	1	Bushings, Outer Shells, Inner Tubes, Inst Sheet	
DEL.	Control Arm Lower-Inner Rear Kit Standard Replacement	<b>MPU-3384K</b>	1	Bushings, Outer Shells, Inner Tubes, Inst Sheet	



## SUZUKI Baleno GA, GS, GL, GLX Sedan ,Wagon - 4/1995 - 1998

Página 1

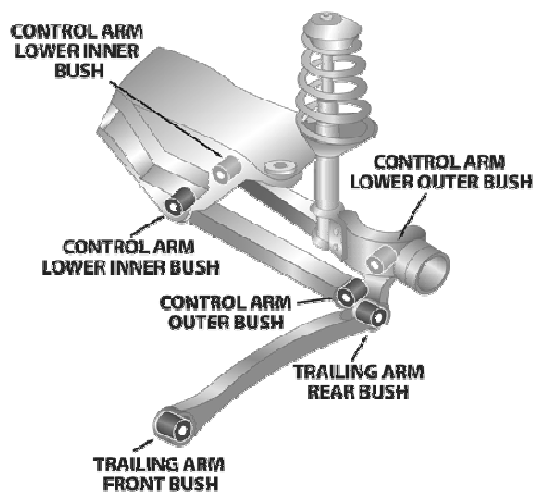
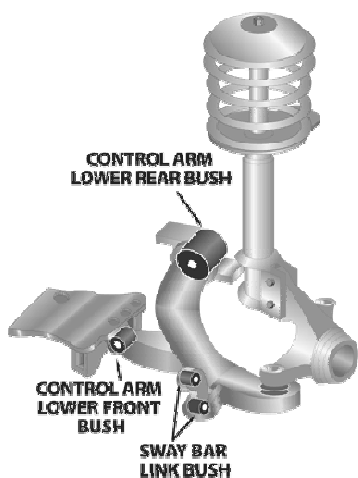





Aplicaci...	Descripción	Referencia	Kits por...	Contenido del Kit	
DEL.	Control Arm Lower Rear Bushing PS & DS standard	<b>MPU-0679K</b>	1	Bushings	
DEL.	Control Arm Lower Rear Bushing PS increased DS standard caster	<b>MPU-1432K</b>	1	Bushings	
DEL.	Control Arm Lower Rear Bushing PS increased, DS decrease or increase caster	<b>MPU-1433K</b>	1	Bushings	
DEL.	Control Arm Lower-Front Bushing	<b>MPU-1431K</b>	1	Bushings, Inner Tubes	
TRAS.	Control Arm-Bush Kit Front & rear arms	<b>MPU-1842K</b>	2	Inner Tubes, Bushings	
TRAS.	Trailing Arm Lower Front Bushing	<b>MPU-1840K</b>	1	Inner Tubes, Bushings	
TRAS.	Trailing Arm Lower Rear Bushing	<b>MPU-1841K</b>	1	Inner Tubes, Bushings	

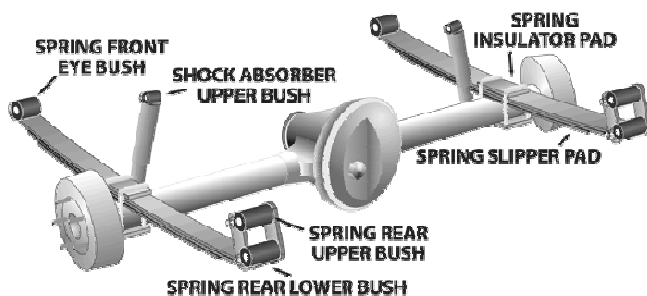
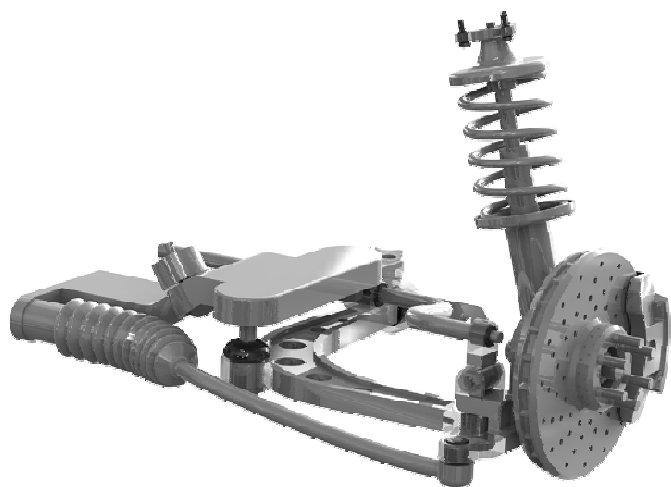

**SUZUKI Super Carry High Roof Van ( SK410 ) - 7/1985 - 1992**

Página 1





Aplicaci...	Descripción	Referencia	Kits por...	Contenido del Kit	
DEL.	Sway Bar Link Bushing Kit	<b>MPU-0903K</b>	1	Bushings	 SPF0903K
TRAS.	Spring Rear Bushing All	<b>MPU-0173K</b>	1	Bushings	 0173K

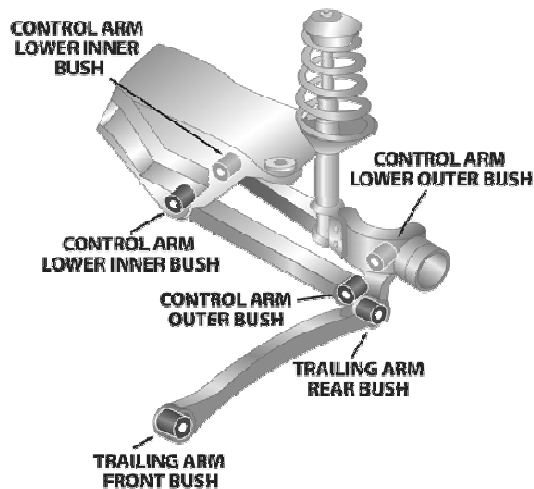
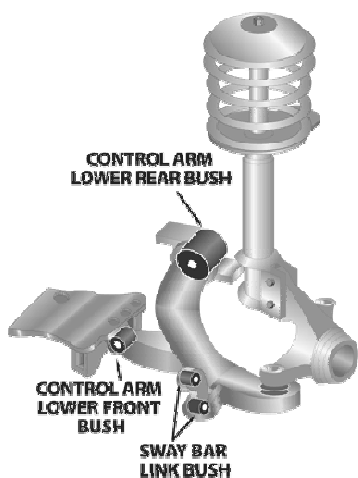

**SUZUKI Liana RH416 & RH418 - 11/2001 -**

Página 1









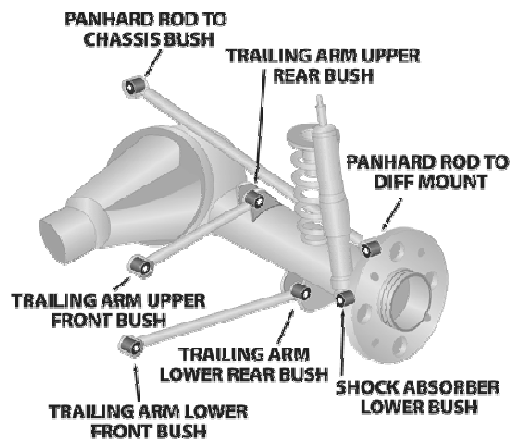
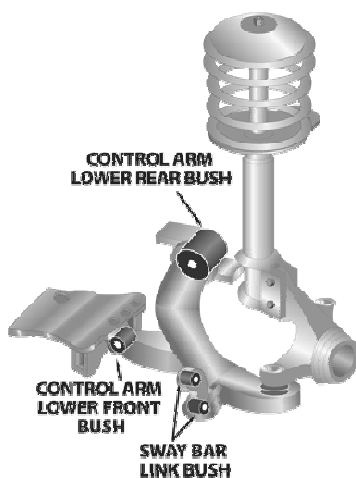

Aplicaci...	Descripción	Referencia	Kits por...	Contenido del Kit	
TRAS.	Sway Bar Mount Bushing Measure bar diameter 15,18mm available,Replaces OE46641-54610 @ 15mm	<b>MPU-2618-__K</b>	1	Bushings	



## SUZUKI Vitara / Escudo / Sidekick JLX Hardtop & Softop 4WD...

Página 1









Aplicaci...	Descripción	Referencia	Kits por...	Contenido del Kit	
DEL.	Coil Spring Spacer Bushing Standard height vehicle	<b>MPU-1028-5K</b>	1	Bushings	
DEL.	Coil Spring Spacer Bushing Raises vehicle approximately 30mm	<b>MPU-1735-15K</b>	2	Bushings	
DEL.	Control Arm Lower Rear Bushing Adjustable caster kit	<b>MPU-0920AK</b>	1	Inner Tubes, Bushings	
DEL.	Control Arm Lower Rear Bushing	<b>MPU-0920K</b>	1	Bushings, Inner Tubes	
DEL.	Control Arm Lower-Front Bushing	<b>MPU-0924K</b>	1	Inner Tubes, Bushings	
DEL.	Sway Bar Link Lower Bushing	<b>MPU-2092BK</b>	1	Bushings	
DEL.	Sway Bar Mount To Chassis Bushing Measure bar diameter 25mm available	<b>MPU-0923-__K</b>	1	Bushings	

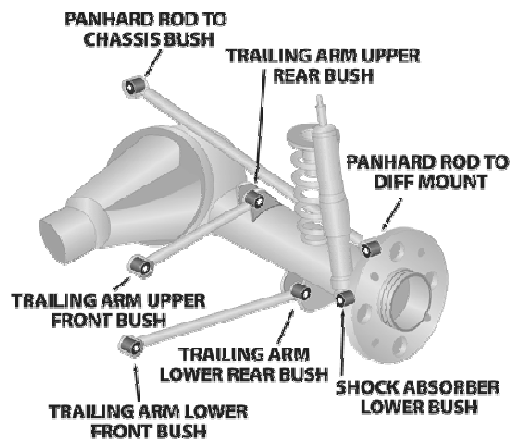
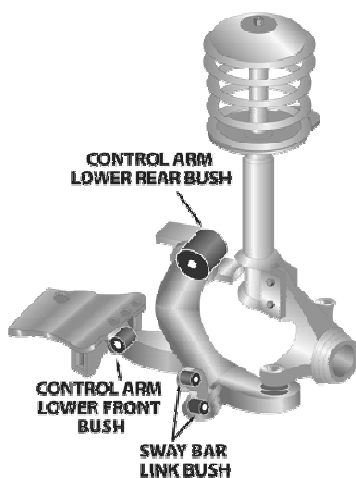

## SUZUKI Vitara / Escudo / Sidekick JLX Hardtop & Softop 4WD...

Página 2 (Continúa)



Aplicaci...	Descripción	Referencia	Kits por...	Contenido del Kit	
TRAS.	Coil Spring Spacer Bushing Standard height vehicle	<b>MPU-1028-5K</b>	1	Bushings	
TRAS.	Coil Spring Spacer Bushing Raises vehicle approximately 30mm	<b>MPU-1735-15K</b>	2	Bushings	
TRAS.	Control Arm Upper-Inner Kit	<b>MPU-0921K</b>	1	Inner Tubes, Bushings	
TRAS.	Trailing Arm Lower Bushing All	<b>MPU-0922K</b>	1	Inner Tubes, Bushings	









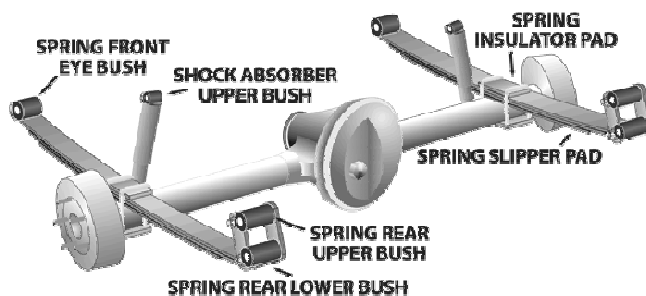
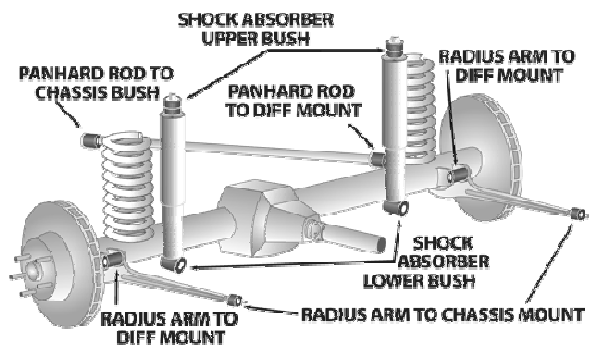



## SUZUKI Jimny JLX Hardtop 4WD - 1998 - Current

Página 1





Aplicaci...	Descripción	Referencia	Kits por...	Contenido del Kit	
DEL.	Panhard Rod Bushing	<b>MPU-1537K</b>	1	Inner Tubes, Bushings	
DEL.	Radius Arm To - Diff Mount Bushing	<b>MPU-1535K</b>	1	Inner Tubes, Bushings	
DEL.	Radius Arm To - Diff Mount Bushing Adjustable caster kit	<b>MPU-1877K</b>	1	Inner Tubes, Bushings	
DEL.	Radius Arm To Chassis Mount Bushing	<b>MPU-1536K</b>	1	Inner Tubes, Bushings	
TRAS.	Panhard Rod Bushing	<b>MPU-1537K</b>	1	Inner Tubes, Bushings	
TRAS.	Radius Arm To - Diff Mount Bushing	<b>MPU-1535K</b>	1	Inner Tubes, Bushings	
TRAS.	Radius Arm To Chassis Mount Bushing	<b>MPU-1536K</b>	1	Inner Tubes, Bushings	

**SUZUKI SS80V Van - 1984**

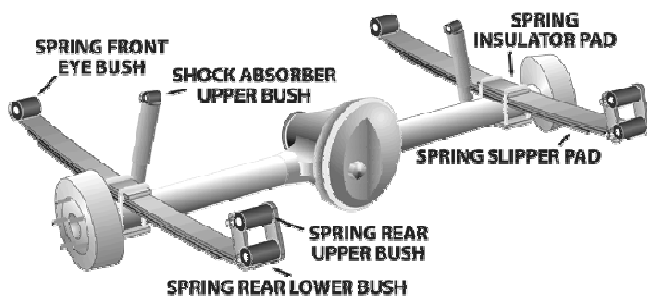
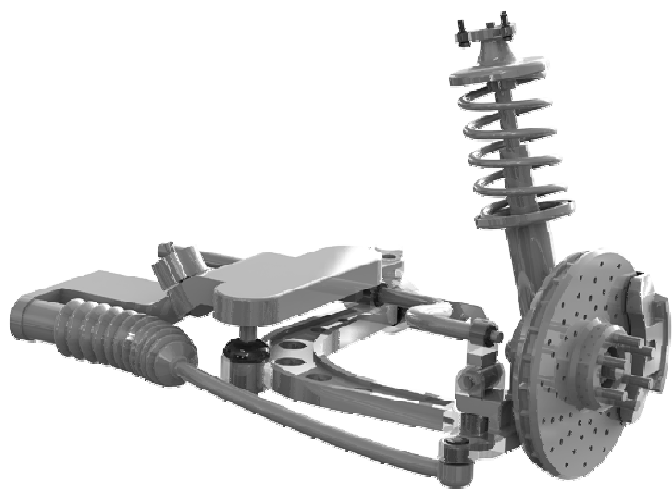
Página 1





Aplicaci...	Descripción	Referencia	Kits por...	Contenido del Kit	
DEL.	Sway Bar To Lower Control Arm Kit	<b>MPU-0161K</b>	1	Bushings	 0161K

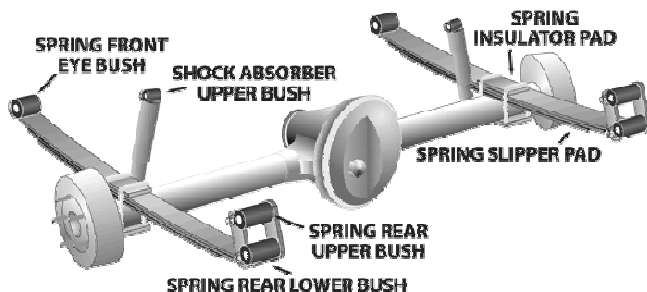
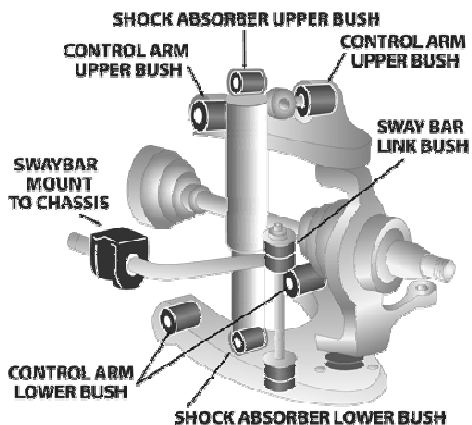

**TATA Telcoline Utility - 1996 - 2001**

Página 1





Aplicaci...	Descripción	Referencia	Kits por...	Contenido del Kit	
DEL.	Control Arm Upper-Inner Kit Re-use original shell.	<b>MPU-1954K</b>	1	Inner Tubes, Bushings	 1954K

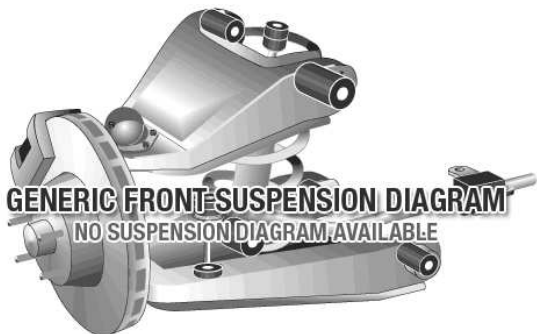

**TATA Xenon Utility - 2010 - Current**

Página 1









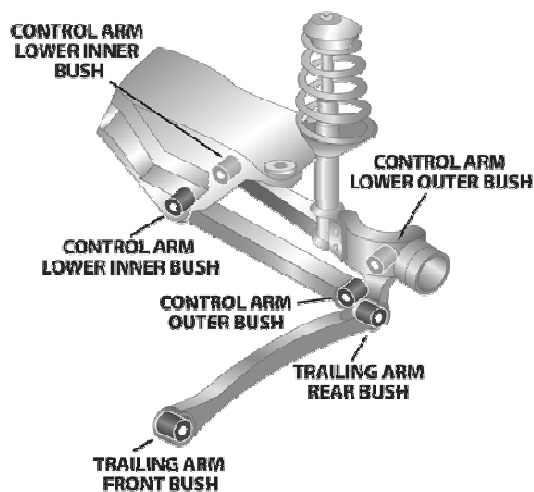
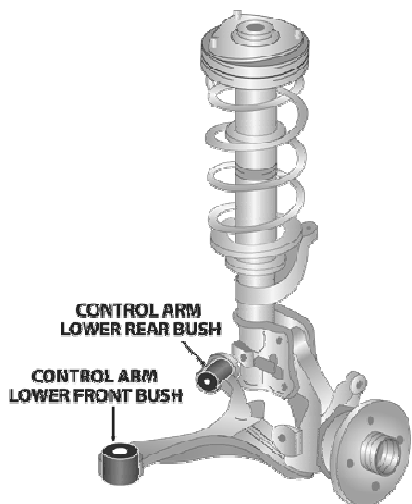

Aplicaci...	Descripción	Referencia	Kits por...	Contenido del Kit	
DEL.	Control Arm Upper-Inner Kit Re-use original shell.	<b>MPU-1954K</b>	1	Inner Tubes, Bushings	



TOYOTA Camry SXV20, MCV20 Series, Sedan & Wagon -...

Página 1







Aplicaci...	Descripción	Referencia	Kits por...	Contenido del Kit	
DEL.	Control Arm Lower Rear Bushing Standard	<b>MPU-1265K</b>	1	Inner Tubes, Bushings	 SPF1265K
DEL.	Control Arm Lower-Front Bushing Re-use original mounting pin	<b>MPU-2663K</b>	1	Bushings	
DEL.	Control Arm Lower-Inner Rear Eccentric Cast Arm, PS increased DS standard alignment settings	<b>MPU-1266K</b>	1	Inner Tubes, Bushings	 1 2 6 6 K
DEL.	Control Arm Lower-Inner Rear Eccentric Cast Arm, PS increased DS decrease alignment settings	<b>MPU-1267K</b>	1	Inner Tubes, Bushings	 1 2 6 7 K
DEL.	Engine Steady Bushing Large end has 50mm inside diameter	<b>MPU-1348K</b>	1	Bushings, Inner Tubes	 1 3 4 8 K
DEL.	Engine Steady Bushing Large end has 65mm inside diameter	<b>MPU-2706K</b>	1	Bushings, Inner Tubes	
DEL.	Steering Rack & Pinion Mount Bush.....Power Steering Power steering	<b>MPU-1191K</b>	1	Inner Tubes, Bushings	 1 1 9 1 K

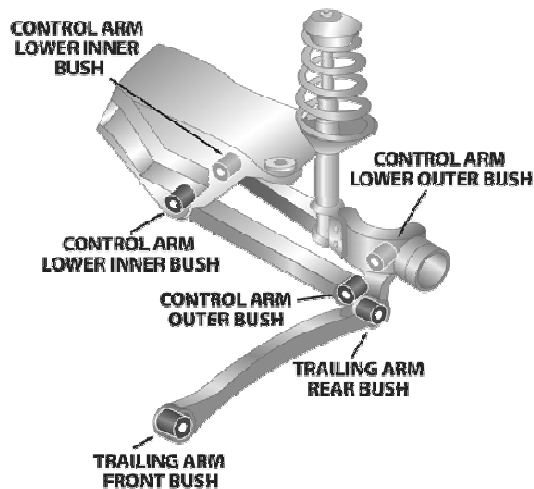
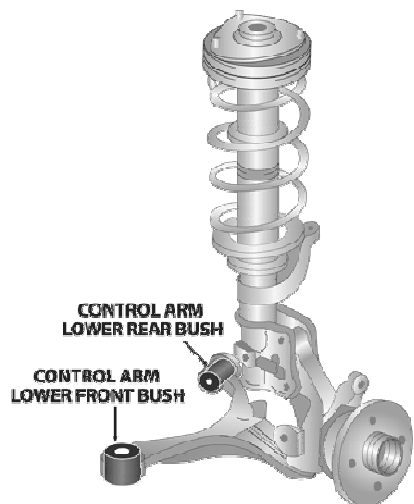

**TOYOTA Camry SXV20, MCV20 Series, Sedan & Wagon -...**

Página 2 (Continúa)









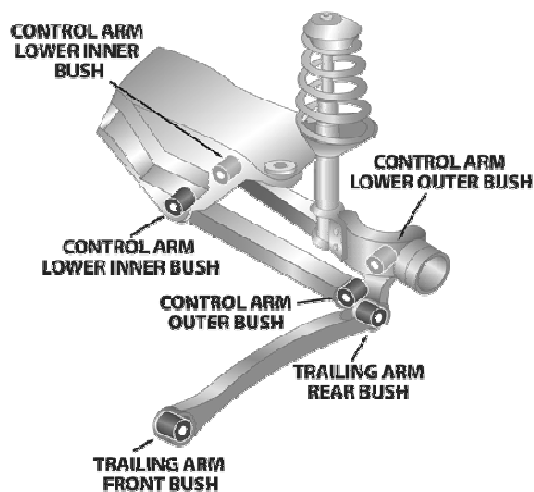
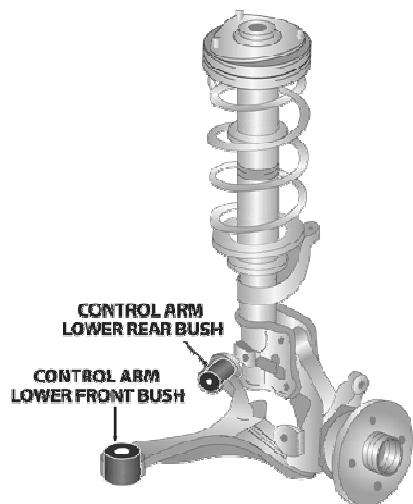

Aplicaci...	Descripción	Referencia	Kits por...	Contenido del Kit	
DEL.	Sway Bar Mount To Chassis Bushing Measure bar diameter 17,18,20,23mm available	<b>MPU-1132-__K</b>	1	Bushings	
TRAS.	Sway Bar Mount To Chassis Bushing Measure bar diameter 15, 16,17 & 20mm available	<b>MPU-2284-__K</b>	1	Bushings	
TRAS.	Trailing Arm - Bushing Kit	<b>MPU-0823K</b>	1	Inner Tubes, Bushings	



## TOYOTA Camry 36 Series, Sedan & Wagon - 10/2002 - 7/2006

Página 1





Aplicaci...	Descripción	Referencia	Kits por...	Contenido del Kit	
DEL.	Control Arm Lower-Inner Front Kit Re-use original mounting pin	<b>MPU-2663K</b>	1	Bushings	
DEL.	Control Arm Lower-Inner Rear Eccentric Pressed Steel Arm, 1 x Standard & 1 x Offset bushing, replaces OE# 4865-06060	<b>MPU-3174K</b>	1	Outer Shells, Inner Tubes, Bushings	
DEL.	Control Arm Lower-Inner Rear Eccentric Press Steel Arm, 2 x Offset bushing, replaces OE# 4865-06060	<b>MPU-3175K</b>	1	Outer Shells, Inner Tubes, Bushings	
DEL.	Control Arm Lower-Inner Rear Kit Standard replacement, OE# 4865-06060	<b>MPU-3173K</b>	1	Outer Shells, Inner Tubes, Bushings	
DEL.	Steering Rack & Pinion Mount Bush.....Power Steering Re-use original strap and crush tube	<b>MPU-2857K</b>	1	Inner Tubes, Bushings	
DEL.	Sway Bar Mount Bushing Measure bar diameter 17,18,20,23mm available	<b>MPU-1132-__K</b>	1	Bushings	
TRAS.	Sway Bar Mount Bushing Measure bar diameter 15, 16,17 & 20mm available	<b>MPU-2284-__K</b>	1	Bushings	

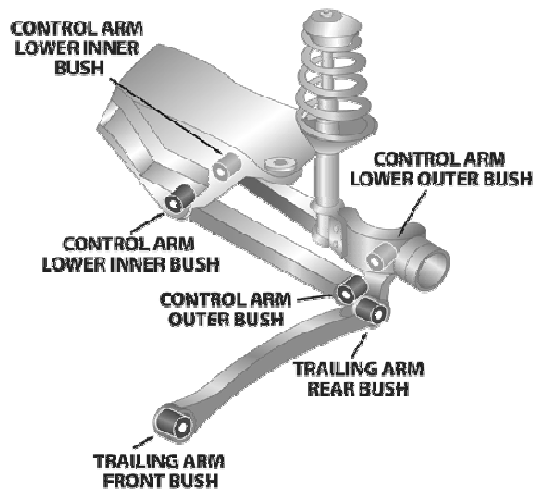
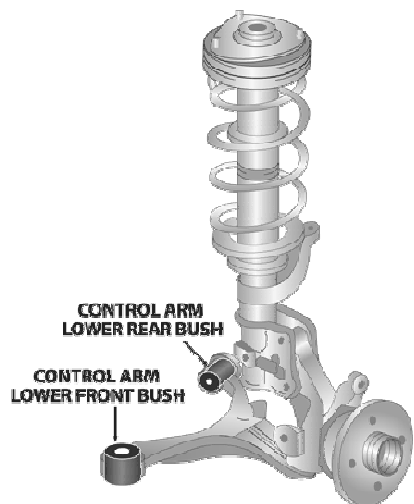

**TOYOTA Camry 36 Series, Sedan & Wagon - 10/2002 - 7/2006**

Página 2 (Continúa)



Aplicaci...	Descripción	Referencia	Kits por...	Contenido del Kit	
TRAS.	Trailing Arm - Bushing Kit	<b>MPU-0823K</b>	1	Inner Tubes, Bushings	 SPF0823K





**TOYOTA Camry XV40 Series - 2006 - 2012**

Página 1

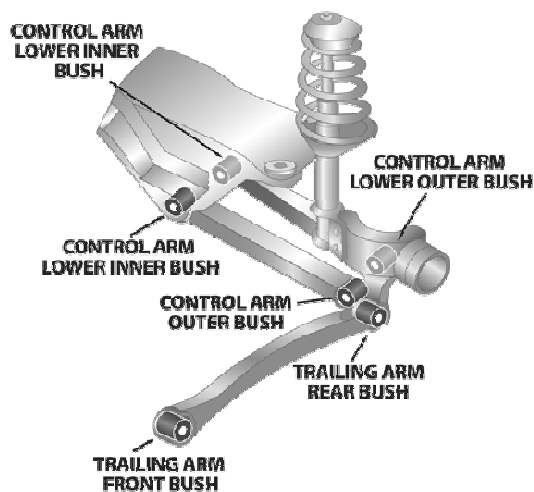
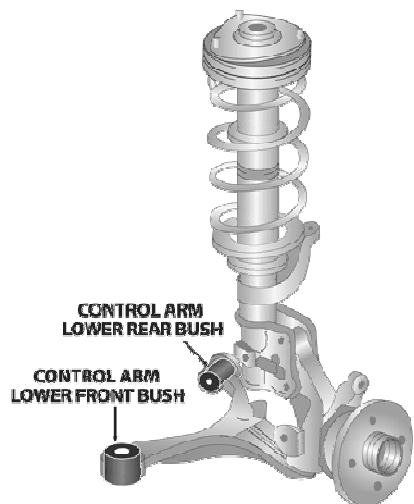







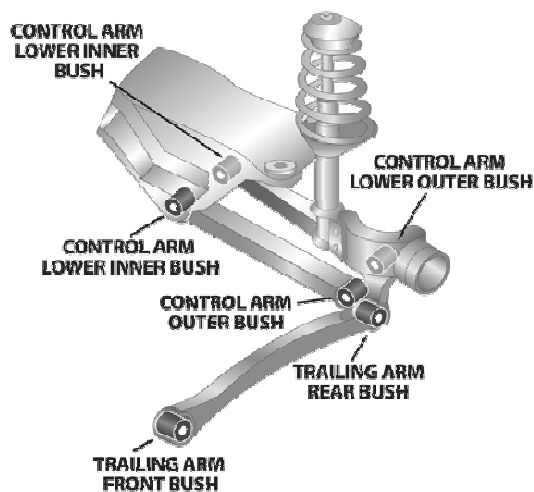
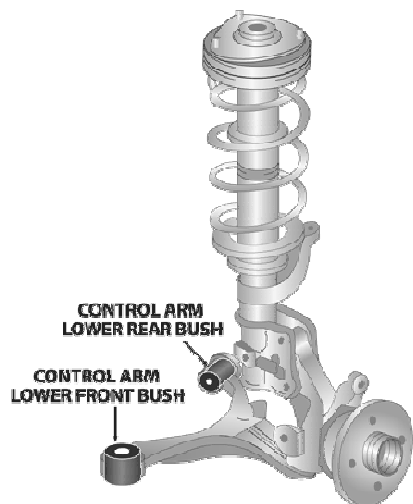

Aplicaci...	Descripción	Referencia	Kits por...	Contenido del Kit	
DEL.	Control Arm Lower-Inner Rear Kit Standard replacement kit	<b>MPU-2902K</b>	1	Outer Shells, Inner Tubes, Bushings	 SPF2902K
DEL.	Control Arm Lower-Inner Rear Kit 1 x Standard bushing & 1 x Offset bushing kit	<b>MPU-2903K</b>	1	Outer Shells, Inner Tubes, Bushings	
DEL.	Control Arm Lower-Inner Rear Kit 2 x Offset bushing kit, Recomendado for vehicles with pull left issues	<b>MPU-2904K</b>	1	Outer Shells, Inner Tubes, Bushings	
DEL.	Steering Rack & Pinion Mount Bush.....Power Steering	<b>MPU-3769K</b>	1	Washers, Inner Tubes, Bushings	 SPF3769K
TRAS.	Lateral Arm Front Outer Bushing	<b>MPU-3880K</b>	1	Inner Tubes, Bushings	
TRAS.	Trailing Arm - Lower Bushing	<b>MPU-0823K</b>	1	Inner Tubes, Bushings	 SPF0823K



TOYOTA Camry SV10, SV11, CV10, CV11, Vista - 4/1983 - ...

Página 1





Aplicaci...	Descripción	Referencia	Kits por...	Contenido del Kit	
DEL.	Control Arm Lower-Inner Bushing	MPU-0510K	1	Inner Tubes, Bushings	
DEL.	Sway Bar To Lower Control Arm Kit 1983 to 6/1984	MPU-0222K	1	Bushings	
DEL.	Sway Bar To Lower Control Arm Kit 7/1984 to 4/1987	MPU-0237K	1	Inner Tubes, Bushings	
TRAS.	Control Arm-Outer Bushing	MPU-0825K	1	Inner Tubes, Bushings	
TRAS.	Sway Bar Link Lower Bushing	MPU-0903-4K	1	Bushings	
TRAS.	Sway Bar Link Upper Bushing	MPU-0280K	1	Inner Tubes, Bushings	
TRAS.	Sway Bar Mount To Chassis Bushing Measure bar diameter 13,14,15,16,18,20mm available	MPU-0199-__K	1	Bushings	

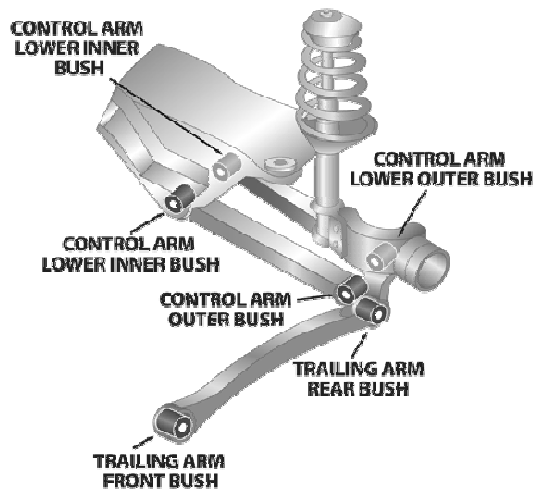
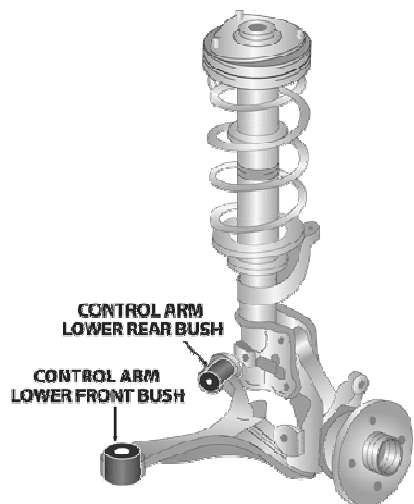

**TOYOTA Camry SV10, SV11, CV10, CV11, Vista - 4/1983 -...**

Página 2 (Continúa)



Aplicaci...	Descripción	Referencia	Kits por...	Contenido del Kit	
TRAS.	Trailing Arm - Bushing Kit	<b>MPU-0823K</b>	1	Inner Tubes, Bushings	 SPF0823K



**TOYOTA Celica ZT 231 - 11/1999 - 2002**

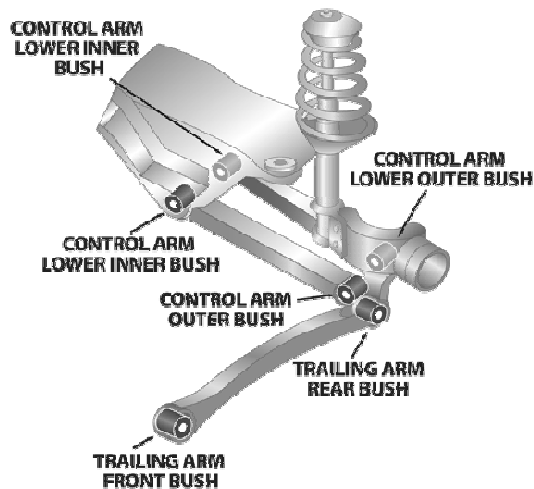
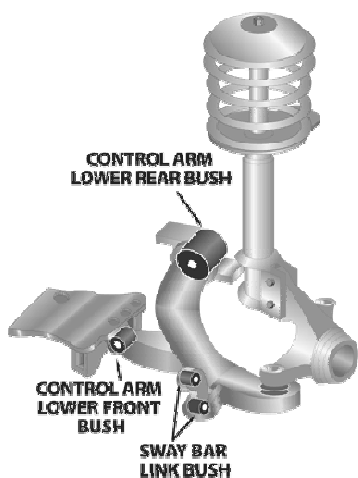



Aplicaci...	Descripción	Referencia	Kits por...	Contenido del Kit	
DEL.	Control Arm Lower-Inner Front Kit	<b>MPU-0996K</b>	1	Inner Tubes, Bushings	
DEL.	Control Arm Lower-Inner Rear Kit Standard replacement	<b>MPU-2085K</b>	1	Outer Shells, Inner Tubes, Bushings	
DEL.	Control Arm Lower-Inner Rear Kit Single offset	<b>MPU-2086K</b>	1	Outer Shells, Inner Tubes, Bushings	
DEL.	Control Arm Lower-Inner Rear Kit Double offset	<b>MPU-2087K</b>	1	Outer Shells, Inner Tubes, Bushings	
DEL.	Control Arm Lower-Inner Rear Kit Double offset & Anti Lift	<b>MPU-2088K</b>	1	Bushings, Inner Tubes, Outer Shells	

## TOYOTA Celica ST204 & ST205 - 3/1994 - 11/1999

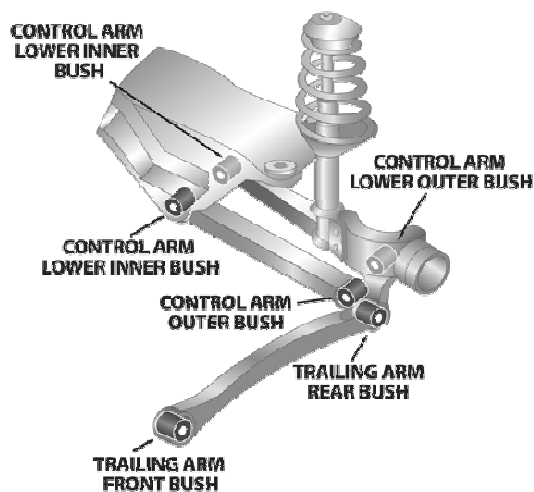
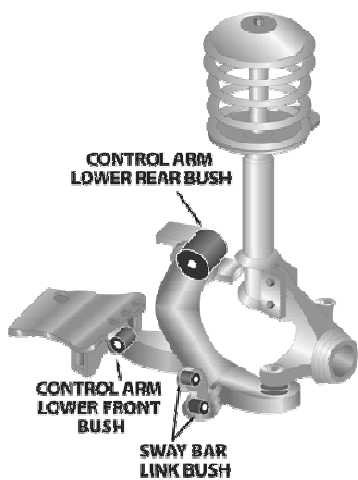
Página 1



Aplicaci...	Descripción	Referencia	Kits por...	Contenido del Kit	
DEL.	Control Arm Lower-Inner Rear Kit ST204 Only, with arm diameter of 60mm, Vertical pivoting bush, replaces OE number 48655-20200	<b>MPU-2742K</b>	1	Outer Shells, Inner Tubes, Bushings	
DEL.	Control Arm Lower-Inner Rear Kit ST205 GT4 Only, with arm diameter of 50mm, Vertical pivoting bush, replaces OE #48655-20230	<b>MPU-2275K</b>	1	Inst Sheet, Outer Shells, Inner Tubes, Bushings	



TOYOTA Celica TA22, TA23, RA23, RA28 - 12/1972 - 1977

Página 1

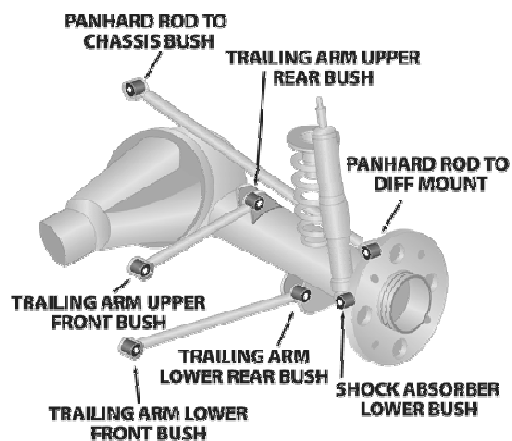
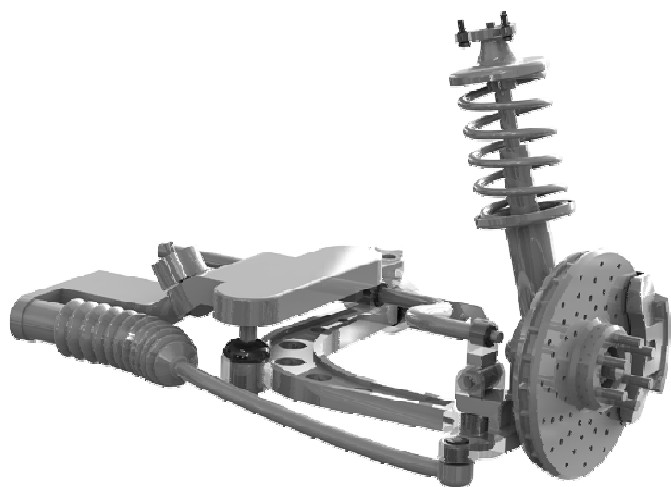





Aplicaci...	Descripción	Referencia	Kits por...	Contenido del Kit	
DEL.	Control Arm Lower-Inner Bushing Re-use original shell	MPU-0509K	1	Inner Tubes, Bushings	
DEL.	Strut Bar To Chassis Mount Kit	MPU-0175K	1	Bushings	
DEL.	Strut Bar To Chassis Mount Kit RA23 & RA28	MPU-0699-19K	1	Bushings	
DEL.	Sway Bar Link Bushing Kit	MPU-2092BK	1	Bushings	
DEL.	Sway Bar Mount To Chassis Bushing Measure bar diameter 18,20,23mm available	MPU-1233-__K	1	Bushings	
TRAS.	Panhard Rod To Chassis Mount Kit	MPU-0427K	1	Bushings, Inner Tubes	
TRAS.	Panhard Rod To Diff Mount Bushing	MPU-0963K	1	Bushings, Inner Tubes	

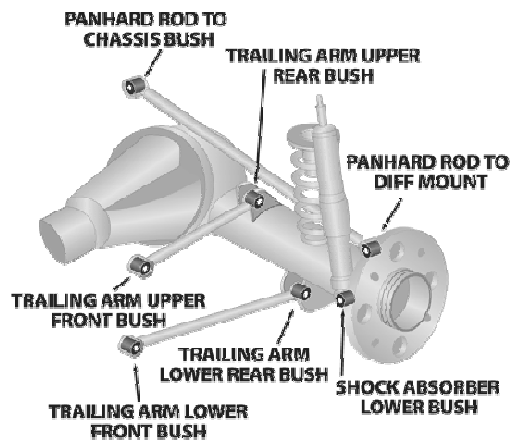
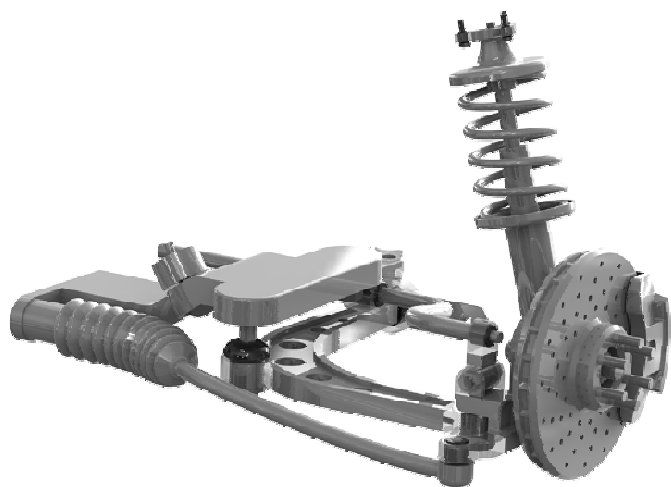

**TOYOTA Celica TA22, TA23, RA23, RA28 - 12/1972 - 1977**

Página 2 (Continúa)



Aplicaci...	Descripción	Referencia	Kits por...	Contenido del Kit	
TRAS.	Shock Absorber Lower Bushing	<b>MPU-2178-16K</b>	1	Bushings	 SPF2178- K
TRAS.	Shock Absorber Upper Bushing	<b>MPU-2755SK</b>	1	Bushings	 SPF2755SK
TRAS.	Trailing Arm Lower Bushing All	<b>MPU-0018K</b>	1	Inner Tubes, Bushings	 0018K
TRAS.	Trailing Arm Upper Bushing All	<b>MPU-0018K</b>	1	Inner Tubes, Bushings	 0018K



TOYOTA Celica RA40 - 8/1977 - 7/1981

Página 1

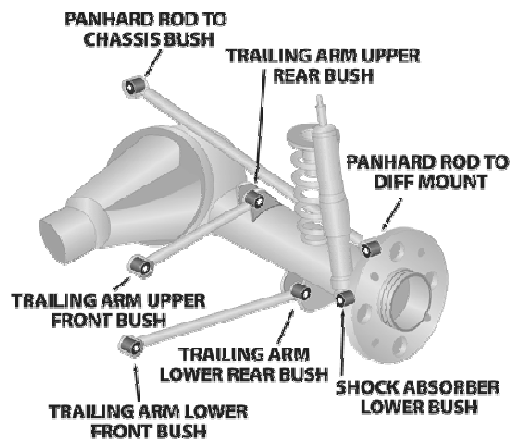
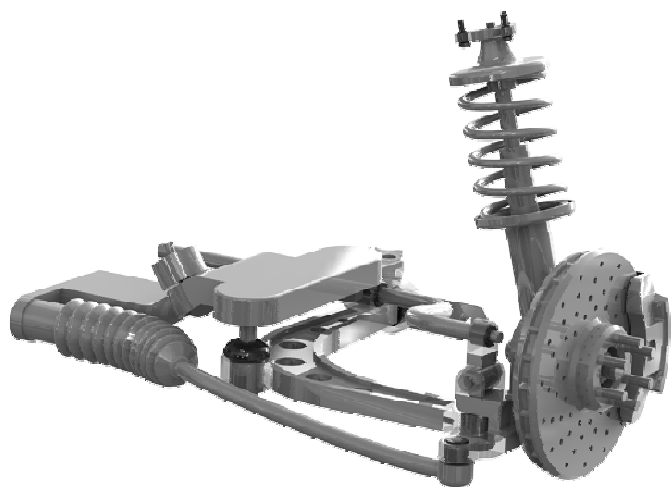

Aplicaci...	Descripción	Referencia	Kits por...	Contenido del Kit	
DEL.	Control Arm Lower-Inner Bushing Re-use original shell	MPU-0509K	1	Inner Tubes, Bushings	
DEL.	Idler Arm Bushing 29mm OD 20mm ID	MPU-0910K	1	Bushings, Inner Tubes	
DEL.	Strut Bar To Chassis Mount Kit	MPU-0307K	1	Bushings	
DEL.	Sway Bar Link Bushing Kit	MPU-2092BK	1	Bushings	
DEL.	Sway Bar Mount To Chassis Bushing Measure bar diameter 21,22,24mm available	MPU-1285-__K	1	Bushings	
TRAS.	Panhard Rod To Chassis Mount Kit	MPU-0427K	1	Bushings, Inner Tubes	
TRAS.	Panhard Rod To Diff Mount Bushing	MPU-0963K	1	Bushings, Inner Tubes	





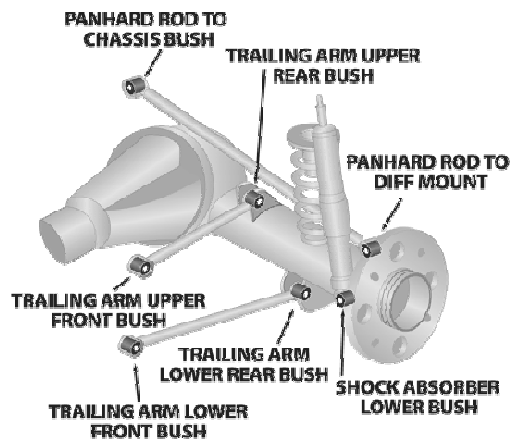
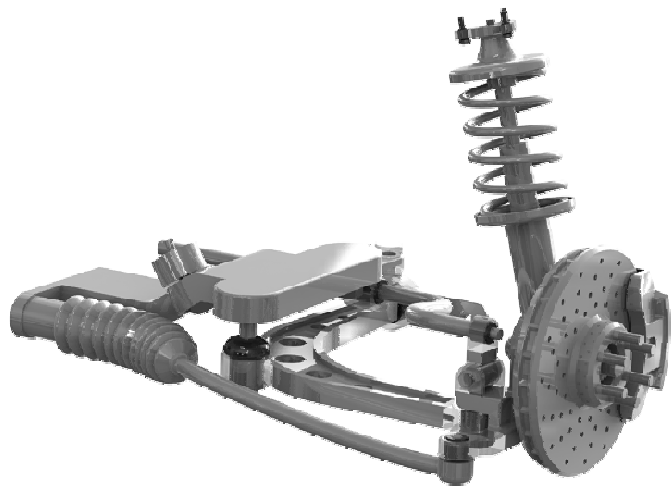

TOYOTA Celica RA40 - 8/1977 - 7/1981

Página 2 (Continúa)



Aplicaci...	Descripción	Referencia	Kits por...	Contenido del Kit	
TRAS.	Trailing Arm Lower Bushing All	MPU-0018K	1	Inner Tubes, Bushings	
TRAS.	Trailing Arm Upper Bushing All	MPU-0018K	1	Inner Tubes, Bushings	



TOYOTA Celica RA60, 63, 65, - 8/1981 - 7/1985

Página 1

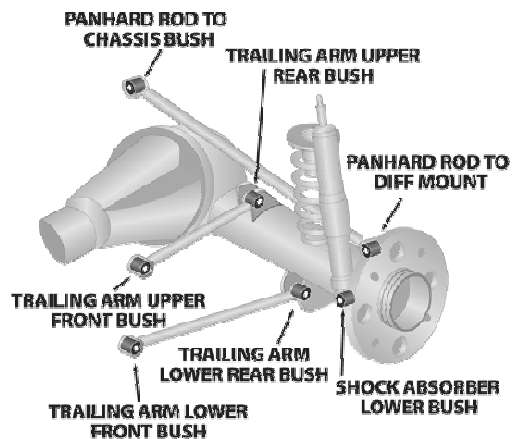
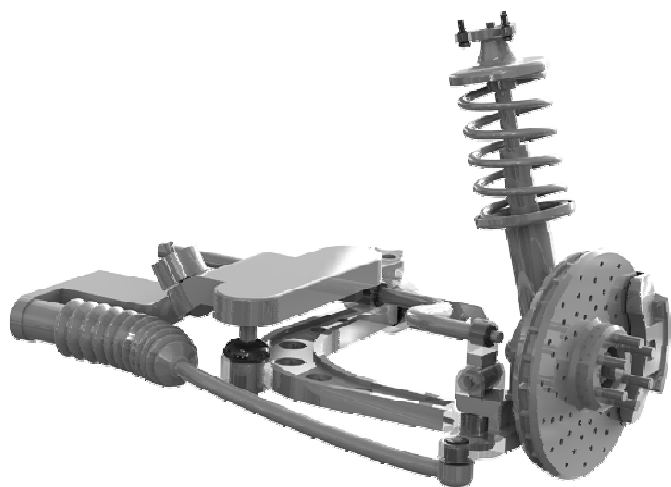







Aplicaci...	Descripción	Referencia	Kits por...	Contenido del Kit	
DEL.	Control Arm Lower-Inner Bushing Re-use original shell	MPU-0509K	1	Inner Tubes, Bushings	
DEL.	Strut Bar To Chassis Mount Kit	MPU-0307K	1	Bushings	
DEL.	Sway Bar Link Bushing Kit	MPU-0903K	1	Bushings	
DEL.	Sway Bar Mount To Chassis Bushing Measure bar diameter 12mm to 30mm available	MPU-1450-__K	1	Bushings	
TRAS.	Control Arm Lower-Inner & Outer Kit Remove OE shell for fitment, 70mm long tubes inner & 65mm tubes outer	MPU-3180K	1	Inner Tubes, Bushings	
TRAS.	Control Arm-Inner Bushing SR63 IRS Suspension, 4 x 70mm long crush tubes, Must re-use original shell	MPU-1213K	1	Inner Tubes, Bushings	
TRAS.	Shock Absorber Lower Bushing	MPU-2178-16K	1	Bushings	

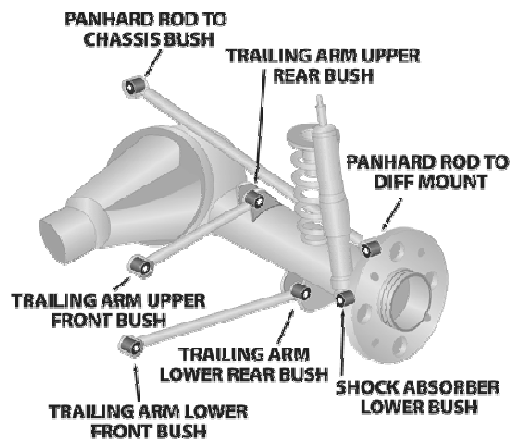
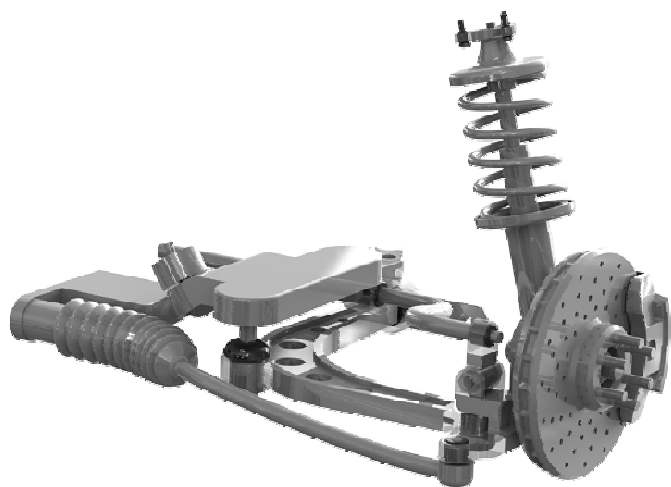

TOYOTA Celica RA60, 63, 65, - 8/1981 - 7/1985

Página 2 (Continúa)









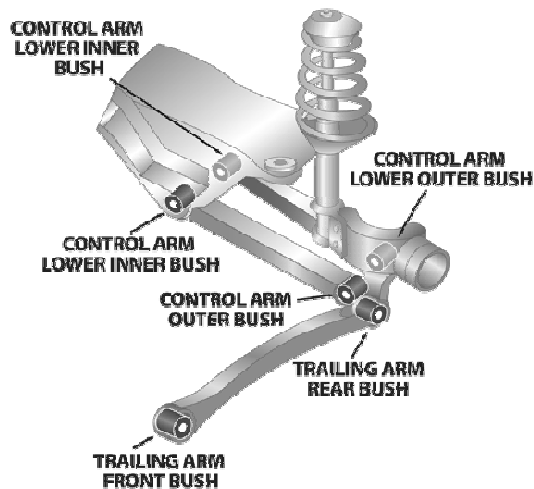
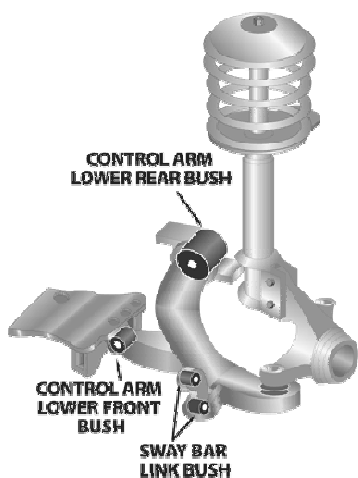

Aplicaci...	Descripción	Referencia	Kits por...	Contenido del Kit	
TRAS.	Shock Absorber Upper Bushing	MPU-2755SK	1	Bushings	
TRAS.	Sway Bar Link Lower Bushing	MPU-0280K	1	Inner Tubes, Bushings	
TRAS.	Sway Bar Link Upper Bushing	MPU-0903-4K	1	Bushings	
TRAS.	Trailing Arm Lower Bushing All Solid axle rear	MPU-0018K	1	Inner Tubes, Bushings	
TRAS.	Trailing Arm Upper Bushing All Solid axle rear	MPU-0018K	1	Inner Tubes, Bushings	



TOYOTA Celica ST162, SX162 & ST165 GT4 - 11/1985-11/1989

Página 1









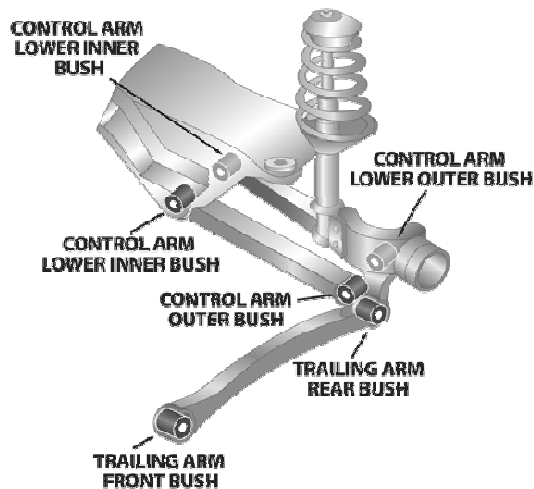
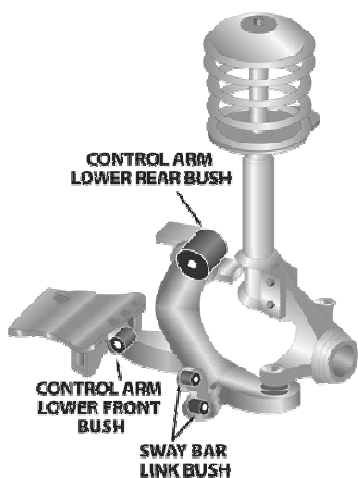

Aplicaci...	Descripción	Referencia	Kits por...	Contenido del Kit	
DEL.	Control Arm Lower Rear Bushing PS & DS standard	<b>MPU-1363K</b>	1	Washers, Inner Tubes, Bushings	
DEL.	Control Arm Lower Rear Bushing PS increased DS standard caster	<b>MPU-1364K</b>	1	Washers, Inner Tubes, Bushings	
DEL.	Control Arm Lower Rear Bushing PS & DS increase caster	<b>MPU-1365AK</b>	1	Bushings, Inner Tubes, Washers	
DEL.	Control Arm Lower Rear Bushing PS increase & DS decrease caster	<b>MPU-1365K</b>	1	Bushings, Inner Tubes, Washers	
DEL.	Control Arm Lower-Front Bushing	<b>MPU-1044K</b>	1	Inner Tubes, Bushings	
DEL.	Sway Bar Mount To Chassis Bushing GT4 ST165, Measure bar diameter 16,21,24,25,26,27 & 28mm available	<b>MPU-1335-__K</b>	1	Bushings	
TRAS.	Control Arm Lower-Inner Bushing GT4 ST165, Large pressed metal arm	<b>MPU-2265K</b>	1	Inner Tubes, Bushings	



TOYOTA Celica ST162, SX162 & ST165 GT4 - 11/1985-11/1989

Página 2 (Continúa)









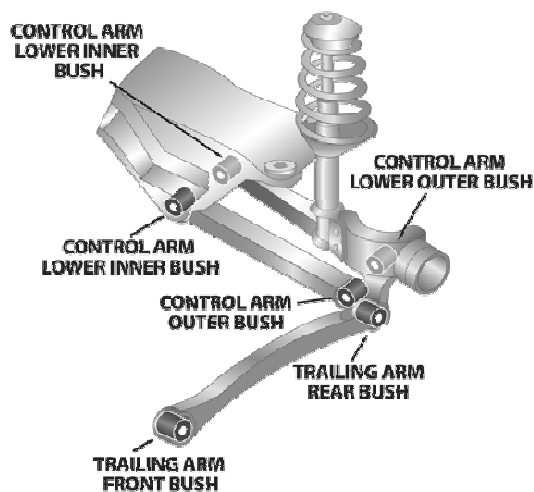
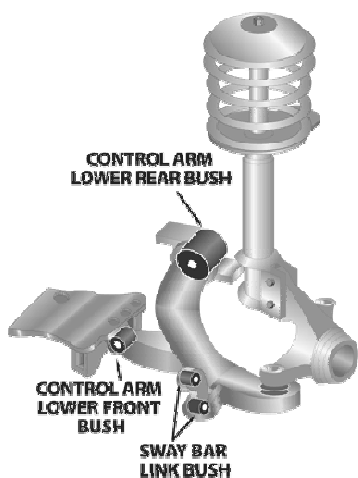

Aplicaci...	Descripción	Referencia	Kits por...	Contenido del Kit	
TRAS.	Control Arm-Outer Bushing Not suited to GT4, Rear arms only, 35mm OD, 14mm bolt	<b>MPU-1220K</b>	1	Bushings, Inner Tubes	
TRAS.	Control Arm-Outer Bushing GT4 ST165, Large pressed metal arm, bushing located in stub axle	<b>MPU-2263K</b>	1	Inner Tubes, Bushings	
TRAS.	Control Arm-Outer Bushing Front arm only	<b>MPU-2372K</b>	1	Bushings, Inner Tubes	
TRAS.	Sway Bar Mount To Chassis Bushing Measure bar diameter 13,19mm available	<b>MPU-0331-__K</b>	1	Bushings	
TRAS.	Toe Control Arm - Inner Bushing GT4 ST165, Rod type arm.	<b>MPU-2264K</b>	1	Inner Tubes, Bushings	
TRAS.	Trailing Arm - Bushing Kit	<b>MPU-0823K</b>	1	Inner Tubes, Bushings	



TOYOTA Celica AT180,ST185,ST184, ST185 GT4 - 12/1989 -...

Página 1



Aplicaci...	Descripción	Referencia	Kits por...	Contenido del Kit	
DEL.	Control Arm Lower Rear Bushing	<b>MPU-1320K</b>	1	Washers, Inner Tubes, Bushings	
DEL.	Control Arm Lower-Front Bushing	<b>MPU-1435K</b>	1	Bushings, Inner Tubes	
DEL.	Sway Bar Mount To Chassis Bushing Measure bar diameter 16,21,24,25,26,27 & 28mm available	<b>MPU-1335-__K</b>	1	Bushings	
TRAS.	Control Arm-Inner Bushing GT4 ST185, Large pressed metal arm	<b>MPU-2265K</b>	1	Inner Tubes, Bushings	
TRAS.	Control Arm-Inner Front Arm Kit ST184, Pressed metal arm	<b>MPU-2730K</b>	1	Inner Tubes, Bushings	
TRAS.	Control Arm-Inner Rear Arm Kit ST184, Rod type arm	<b>MPU-1221K</b>	1	Inner Tubes, Bushings	
TRAS.	Control Arm-Outer Bushing GT4 ST185, Large pressed metal arm, bushing located in stub axle	<b>MPU-2263K</b>	1	Inner Tubes, Bushings	



TOYOTA Celica AT180,ST185,ST184, ST185 GT4 - 12/1989 - ...

Página 2 (Continúa)

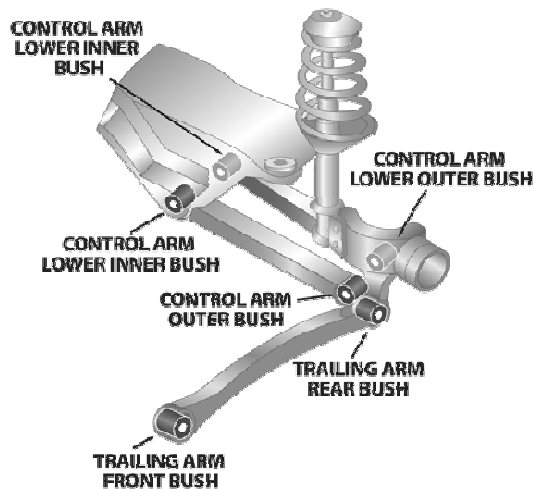
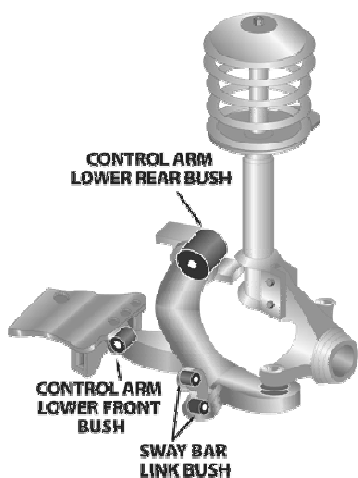







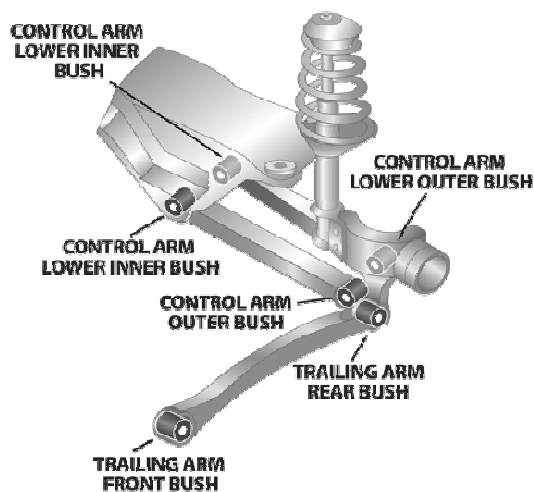
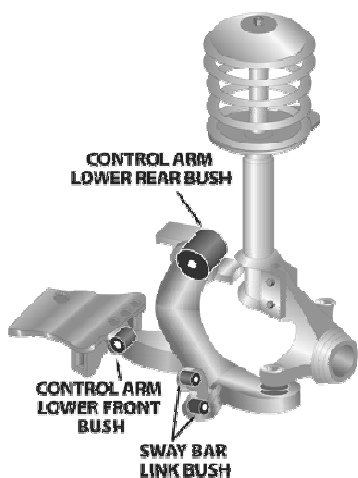

Aplicaci...	Descripción	Referencia	Kits por...	Contenido del Kit	
TRAS.	Control Arm-Outer Bushing ST184, Kit replaces hyme joint style bushing located in hub	MPU-2731K	1	Inner Tubes, Bushings	
TRAS.	Differential Support Bracket Mount Kit NOTE	MPU-2032K	1	Bushings	
TRAS.	Sway Bar Mount To Chassis Bushing Measure bar diameter 14,16,17mm available	MPU-0462-__K	1	Bushings	
TRAS.	Toe Control Arm - Inner Bushing GT4 ST185, Rod type arm	MPU-2264K	1	Inner Tubes, Bushings	
TRAS.	Trailing Arm - Bushing Kit	MPU-0823K	1	Inner Tubes, Bushings	



TOYOTA Corolla AE101R, AE102X (Series 1) - 9/1994 - 11/2001

Página 1



Aplicaci...	Descripción	Referencia	Kits por...	Contenido del Kit	
DEL.	Control Arm Lower Rear Bushing Standard 8/1995 - 7/1999	MPU-1900K	1	Outer Shells, Inner Tubes, Bushings	
DEL.	Control Arm Lower Rear Bushing PS increase caster DS standard caster, 8/1995-7/1996	MPU-1901K	1	Bushings, Inner Tubes, Outer Shells	
DEL.	Control Arm Lower Rear Bushing 7/1994 to 7/1995 "NOT Vertical Type Pivoting Style Bushing" Replaces original bushing # 48655-...	MPU-2298K	1	Washers, Inner Tubes, Bushings	
DEL.	Control Arm Lower-Inner Front Kit	MPU-0996K	1	Inner Tubes, Bushings	
DEL.	Sway Bar Mount To Chassis Bushing Measure bar diameter 20,22 & 25mm available	MPU-0832-__K	1	Bushings	
TRAS.	Control Arm-Bush Kit Suited to vehicles with inside diameter of housing being 28mm	MPU-1947K	1	Inner Tubes, Bushings	
TRAS.	Control Arm-Front Inner & Outer Kit Bore diameter is 31mm. Suited to vehicles with Hyme joint rear control arms	MPU-2938K	1	Inner Tubes, Bushings	





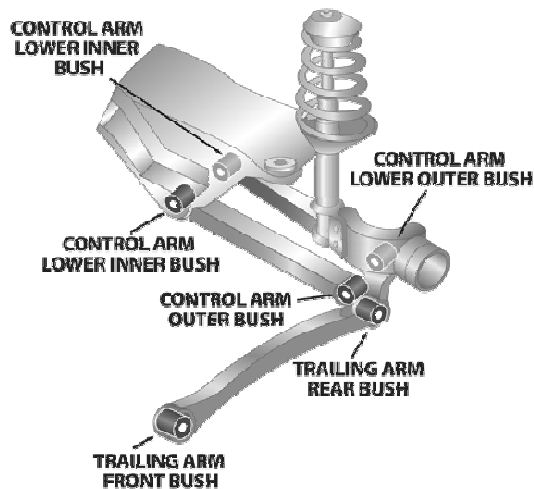
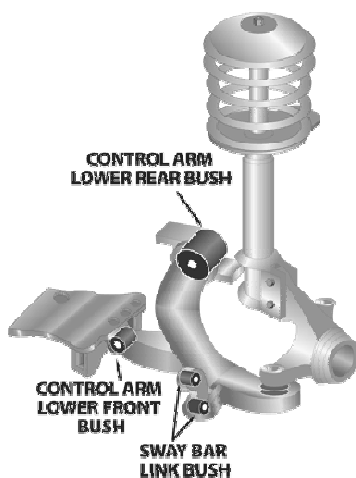

**TOYOTA Corolla AE101R, AE102X (Series 1) - 9/1994 - 11/2001**

Página 2 (Continúa)







Aplicaci...	Descripción	Referencia	Kits por...	Contenido del Kit	
TRAS.	Sway Bar Mount To Chassis Bushing Bar diameter 12,14,15,17,18,19,20,22, 22.5,24,25mm available	<b>MPU-0613-__K</b>	1	Bushings	
TRAS.	Trailing Arm - Bushing Kit	<b>MPU-0823K</b>	1	Inner Tubes, Bushings	 SPF0823K

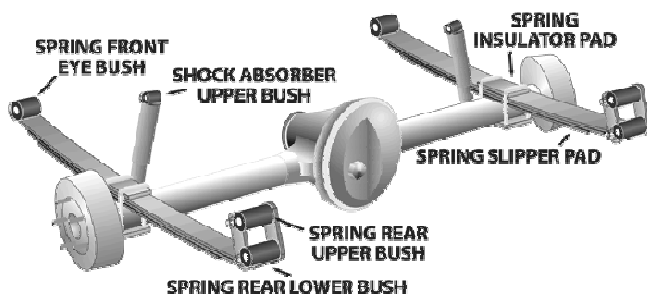
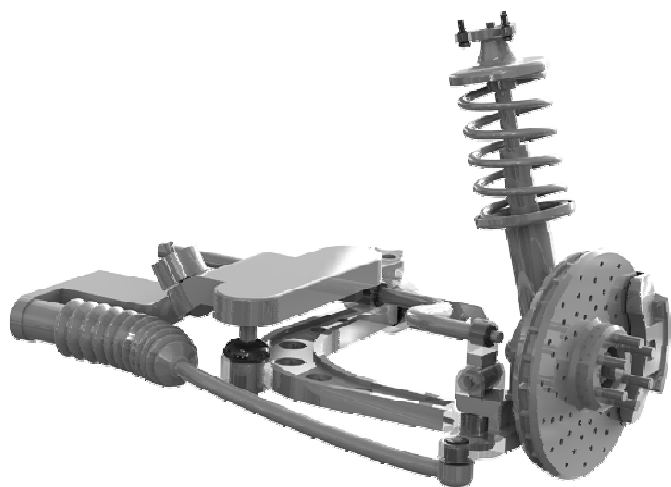

**TOYOTA Corolla EL31 1500 - 1986 - 1990**

Página 1







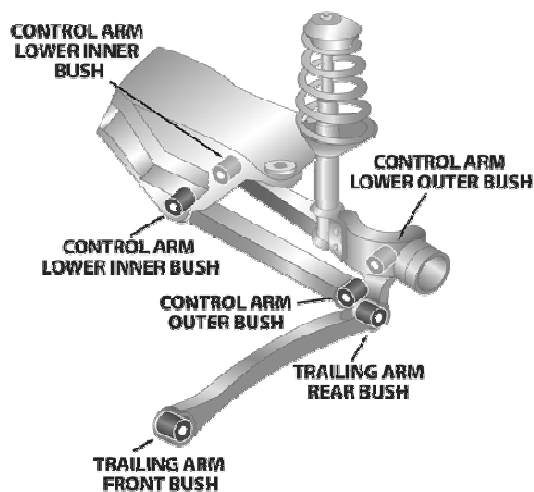

Aplicaci...	Descripción	Referencia	Kits por...	Contenido del Kit	
DEL.	Control Arm Lower-Inner Front Kit	<b>MPU-1888K</b>	1	Bushings, Inner Tubes	
DEL.	Control Arm Lower-Inner Rear Kit Suits 50mm short mounting bracket,OE # 48652-10020, Do not remove original tube from arm	<b>MPU-1906K</b>	1	Bushings	
DEL.	Sway Bar Mount To Chassis Bushing Measure bar diameter 15,18,20,22,24mm available	<b>MPU-0627-__K</b>	1	Bushings	

**TOYOTA Corolla ZZE122R - 12/2001 - 5/2007**

Página 1









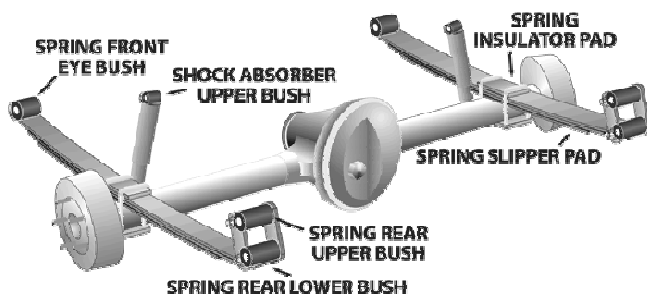
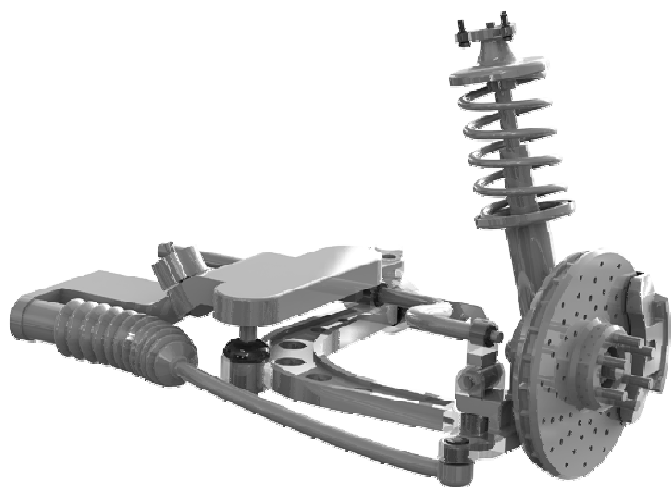

Aplicaci...	Descripción	Referencia	Kits por...	Contenido del Kit	
DEL.	Control Arm Lower-Inner Front Kit	<b>MPU-0996K</b>	1	Inner Tubes, Bushings	
DEL.	Control Arm Lower-Inner Rear Eccentric 1 x Standard bushing & 1 x offset bushing, replaces original part number 48655-12200	<b>MPU-3177K</b>	1	Outer Shells, Inner Tubes, Bushings	
DEL.	Control Arm Lower-Inner Rear Eccentric 2 x Offset bushings, replaces original part number 48655-12200	<b>MPU-3178K</b>	1	Outer Shells, Inner Tubes, Bushings	
DEL.	Control Arm Lower-Inner Rear Kit Standard replacement, replaces original part number 48655-12200	<b>MPU-3176K</b>	1	Outer Shells, Inner Tubes, Bushings	
DEL.	Sway Bar Mount Bushing Measure bar diameter	<b>MPU-3179-__K</b>	1	Bushings	



**TOYOTA Corolla KE10, KE11 Sedan, KE16, KE18 Wagon - 1966...**

Página 1









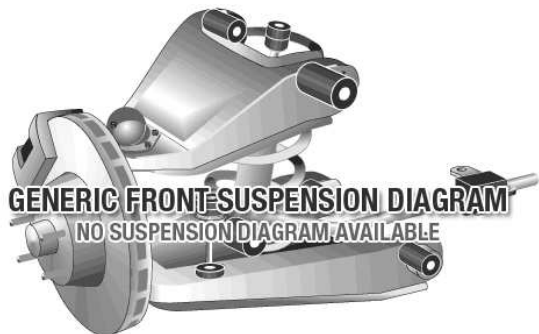

Aplicaci...	Descripción	Referencia	Kits por...	Contenido del Kit	
DEL.	Idler Arm Bushing	<b>MPU-0686K</b>	1	Bushings, Inner Tubes	
DEL.	Idler Arm Bushing	<b>MPU-0686K</b>	1	Bushings, Inner Tubes	
TRAS.	Leaf Spring Bushing All	<b>MPU-0049K</b>	1	Bushings	
TRAS.	Spring Front Eye Bushing 49.4mm OD bushing	<b>MPU-0048K</b>	1	Bushings	
TRAS.	Leaf Spring Bushing All	<b>MPU-0049K</b>	1	Bushings	
TRAS.	Spring Front Eye Bushing 49.4mm OD bushing	<b>MPU-0048K</b>	1	Bushings	



TOYOTA Corolla E140 / E150 - 2006 - 2012

Página 1





Aplicaci...	Descripción	Referencia	Kits por...	Contenido del Kit	
DEL.	Control Arm Lower-Inner Front Kit	<b>MPU-3589K</b>	1	Inner Tubes, Bushings	
DEL.	Control Arm Lower-Inner Rear Eccentric DOUBLE OFFSET KIT.	<b>MPU-3867K</b>	1	Outer Shells, Inner Tubes, Bushings	 SPF3867K
DEL.	Control Arm Lower-Inner Rear Eccentric SINGLE OFFSET KIT	<b>MPU-3866K</b>	1	Outer Shells, Inner Tubes, Bushings	 SPF3866K
DEL.	Control Arm Lower-Inner Rear Kit STANDARD REPLACEMENT	<b>MPU-3588K</b>	1	Outer Shells, Inner Tubes, Bushings	
DEL.	Control Arm Lower-Inner Front Kit	<b>MPU-3589K</b>	1	Inner Tubes, Bushings	
DEL.	Control Arm Lower-Inner Rear Eccentric DOUBLE OFFSET KIT.	<b>MPU-3867K</b>	1	Outer Shells, Inner Tubes, Bushings	 SPF3867K
DEL.	Control Arm Lower-Inner Rear Eccentric SINGLE OFFSET KIT	<b>MPU-3866K</b>	1	Outer Shells, Inner Tubes, Bushings	 SPF3866K

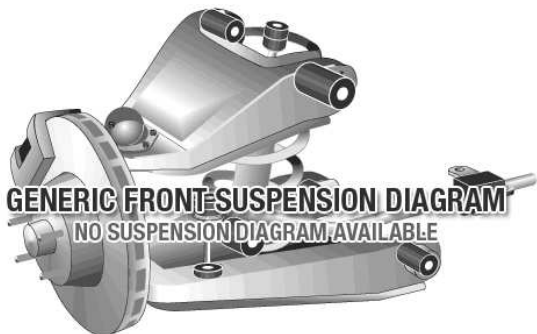

**TOYOTA Corolla E140 / E150 - 2006 - 2012**

Página 2 (Continúa)









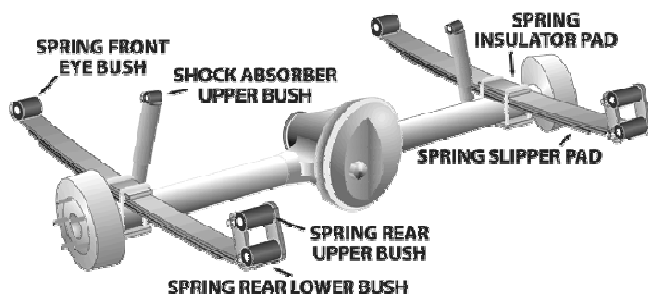
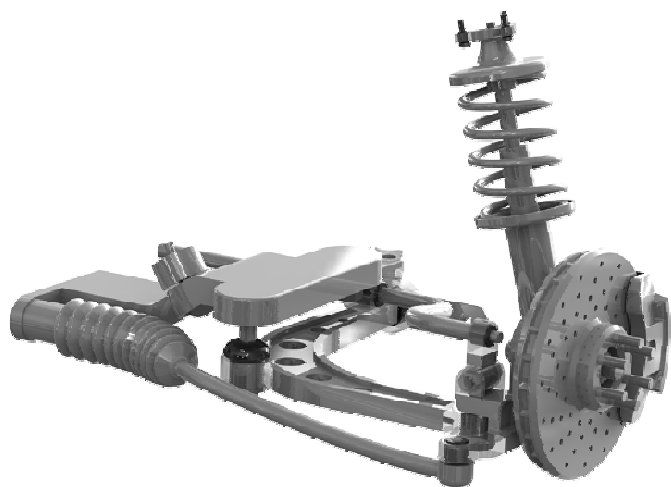

Aplicaci...	Descripción	Referencia	Kits por...	Contenido del Kit	
DEL.	Control Arm Lower-Inner Rear Kit STANDARD REPLACEMENT	<b>MPU-3588K</b>	1	Outer Shells, Inner Tubes, Bushings	



## TOYOTA Corolla KE20, KE25, KE26 - 1972 - 1975

Página 1





Aplicaci...	Descripción	Referencia	Kits por...	Contenido del Kit	
DEL.	Control Arm Lower-Inner Bushing Re-use original shell	<b>MPU-0509K</b>	1	Inner Tubes, Bushings	
DEL.	Idler Arm Bushing	<b>MPU-1614K#R&amp;D</b>	1	Inner Tubes, Bushings	
DEL.	Strut Bar To Chassis Mount Kit	<b>MPU-0198K</b>	1	Bushings	
DEL.	Sway Bar Link Bushing Kit	<b>MPU-0903K</b>	1	Bushings	
DEL.	Sway Bar Mount To Chassis Bushing Measure bar diameter 18mm available	<b>MPU-1613-__K</b>	1	Bushings	
TRAS.	Spring Front Eye Bushing 49.4mm OD bushing	<b>MPU-0048K</b>	1	Bushings	

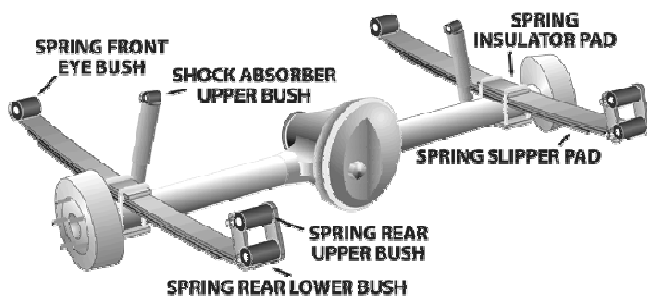
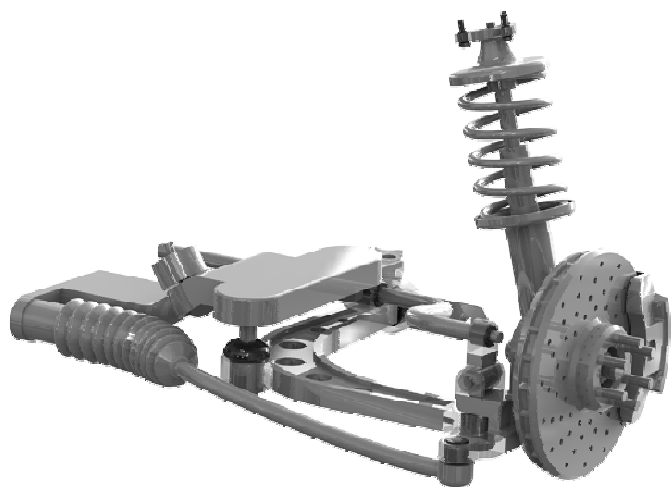

**TOYOTA Corolla KE20, KE25, KE26 - 1972 - 1975**

Página 2 (Continúa)



Aplicaci...	Descripción	Referencia	Kits por...	Contenido del Kit	
TRAS.	Spring Rear Bushing All	MPU-0049K	1	Bushings	 0049K





TOYOTA Corolla KE30, KE35, KE50, KE55 - 1974 - 1981

Página 1

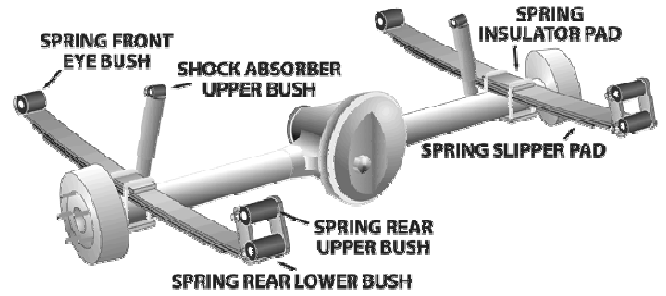
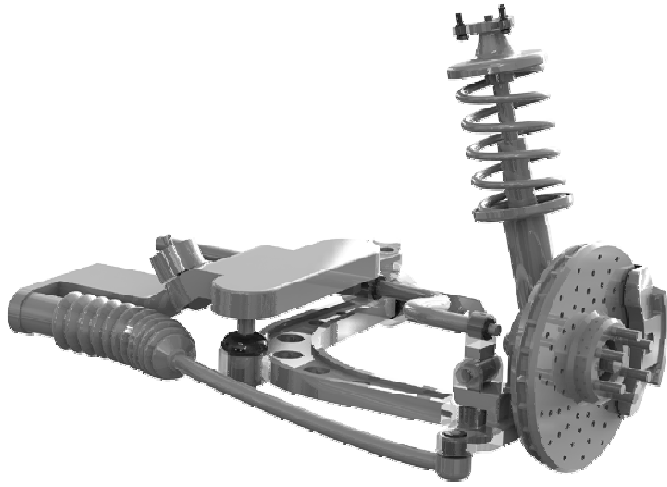

Aplicaci...	Descripción	Referencia	Kits por...	Contenido del Kit	
DEL.	Control Arm Lower-Inner Bushing Re-use original shell	MPU-0509K	1	Inner Tubes, Bushings	
DEL.	Idler Arm Bushing 29mm OD 20mm ID	MPU-0910K	1	Bushings, Inner Tubes	
DEL.	Idler Arm Bushing KE30 model 24.1mm OD & 17.5mm ID	MPU-1310K	1	Bushings	
DEL.	Strut Bar To Chassis Mount Kit	MPU-0699-22K	1	Bushings	
DEL.	Sway Bar Link Bushing Kit	MPU-0903K	1	Bushings	
DEL.	Sway Bar Mount To Chassis Bushing KE38; Measure bar diameter 20,22,23,24,25,26,27,28,29,30,31,32,34mm...	MPU-1155-__K	1	Bushings	
DEL.	Sway Bar Mount To Chassis Bushing KE55, Measure bar diameter 15,18mm available	MPU-2400-__K	1	Bushings	



**TOYOTA Corolla KE30, KE35, KE50, KE55 - 1974 - 1981**

Página 2 (Continúa)

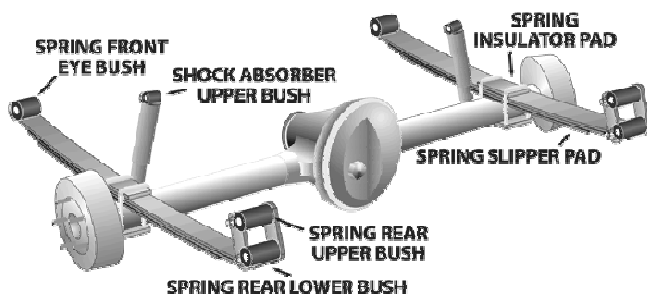
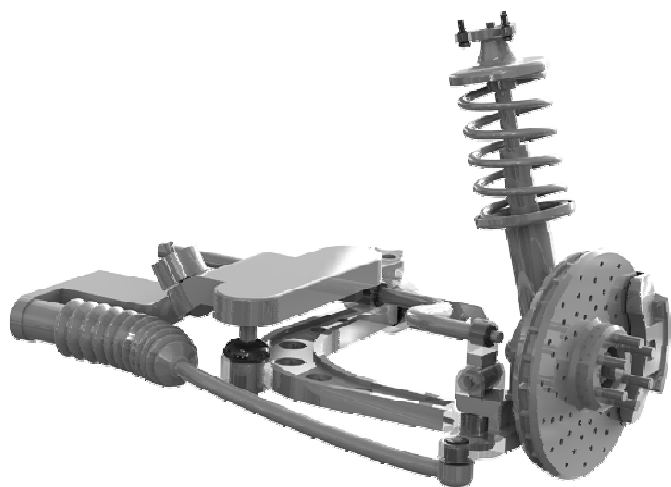







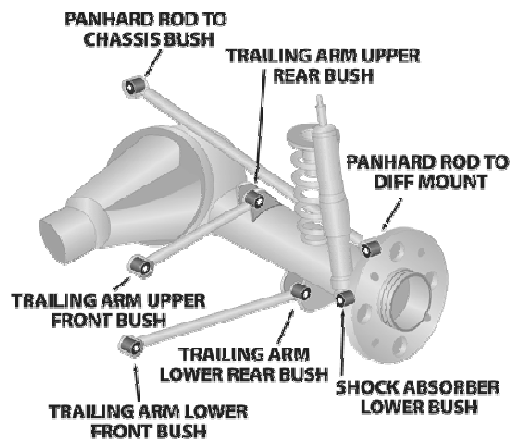
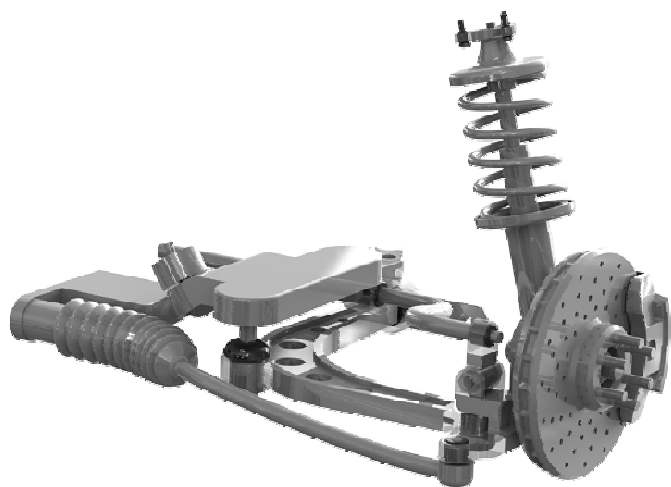

Aplicaci...	Descripción	Referencia	Kits por...	Contenido del Kit	
TRAS.	Spring Front Eye Bushing 35mm OD Bush.	<b>MPU-0891K</b>	1	Bushings	
TRAS.	Spring Front Eye Bushing 50mm OD Bush.	<b>MPU-1385K</b>	1	Bushings	
TRAS.	Spring Rear Bushing All	<b>MPU-0890K</b>	1	Bushings	



TOYOTA Corolla AE86, Sprinter - 5/1983 - 5/1987

Página 1









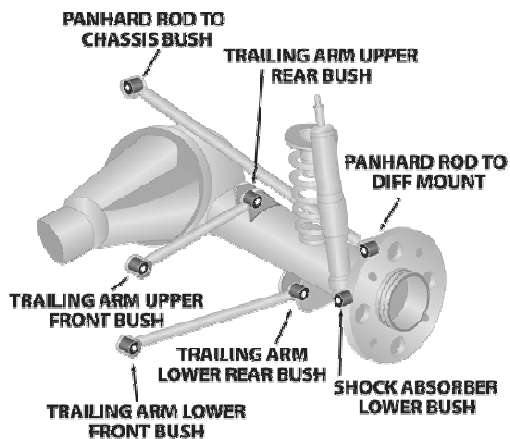
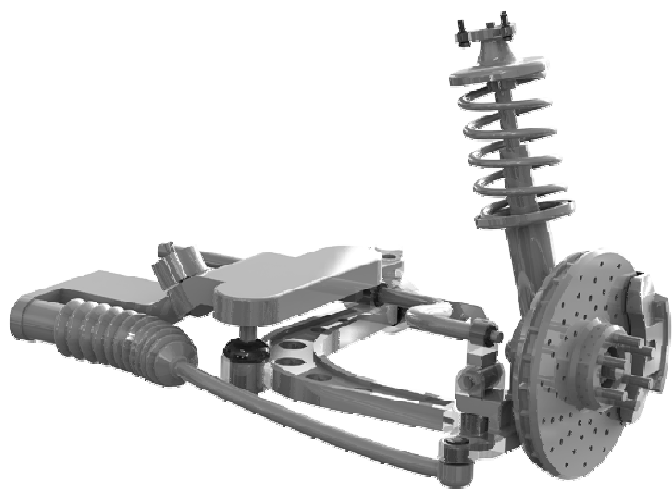

Aplicaci...	Descripción	Referencia	Kits por...	Contenido del Kit	
DEL.	Control Arm Lower-Inner Bushing Re-use original shell	MPU-0509K	1	Inner Tubes, Bushings	
DEL.	Steering Rack & Pinion Mount Bushing	MPU-2988K	1	Bushings	
DEL.	Strut Bar To Chassis Mount Kit	MPU-0699-19K	1	Bushings	
DEL.	Sway Bar Link Bushing Kit	MPU-2092BK	1	Bushings	
DEL.	Sway Bar Mount To Chassis Bushing Measure bar diameter 12mm to 30mm available	MPU-1450-__K	1	Bushings	
TRAS.	Panhard Rod Bushing 35mm OD, 30mm wide bracket, 19.9 ID, cotton reel type	MPU-1827K	1	Bushings	
TRAS.	Panhard Rod To Chassis Mount Kit 32mm OD, 28mm wide bracket, 12 ID, Cotton reel	MPU-0427K	1	Bushings, Inner Tubes	



TOYOTA Corolla AE86, Sprinter - 5/1983 - 5/1987

Página 2 (Continúa)







Aplicaci...	Descripción	Referencia	Kits por...	Contenido del Kit	
TRAS.	Panhard Rod To Diff Mount Bushing Tapered cotton reel style bush	<b>MPU-0963K</b>	1	Bushings, Inner Tubes	
TRAS.	Sway Bar Link Lower Bushing	<b>MPU-0280K</b>	1	Inner Tubes, Bushings	
TRAS.	Sway Bar Link Upper Bushing	<b>MPU-0903-4K</b>	1	Bushings	
TRAS.	Sway Bar Mount Bushing Measure bar diameter 13,14,17,18,19,20,21,22,23mm available	<b>MPU-0873-__K</b>	1	Bushings	
TRAS.	Trailing Arm Lower Bushing All	<b>MPU-0980K</b>	1	Inner Tubes, Bushings	
TRAS.	Trailing Arm Upper Bushing All	<b>MPU-0980K</b>	1	Inner Tubes, Bushings	

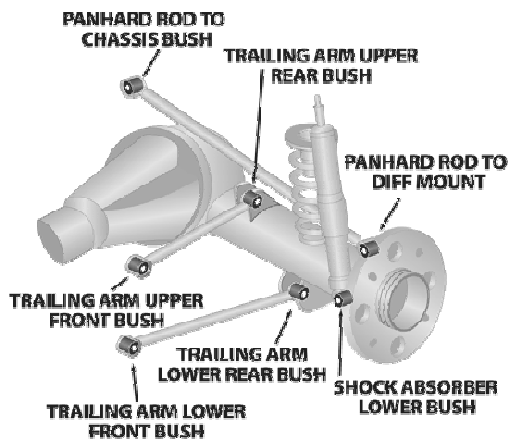
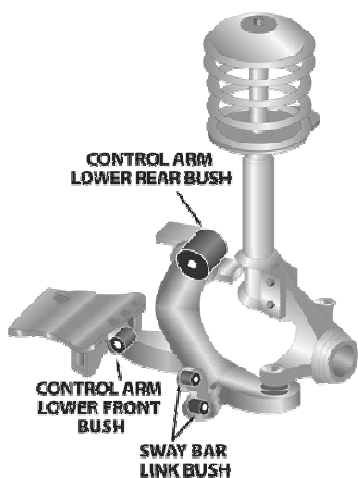

**TOYOTA Corona ST190,AT220,CT220,ST220 - 10/1997 - 07/2000**

Página 1





Aplicaci...	Descripción	Referencia	Kits por...	Contenido del Kit	
DEL.	Control Arm Lower-Inner Front Kit	<b>MPU-1346K</b>	1	Inner Tubes, Bushings	
DEL.	Control Arm Lower-Inner Rear Kit Vertical pivoting bush	<b>MPU-2742K</b>	1	Outer Shells, Inner Tubes, Bushings	

**TOYOTA Corona ST170 Grey Import - 1987 -1992**

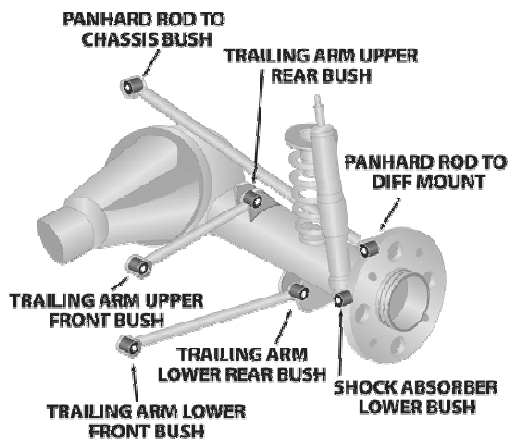
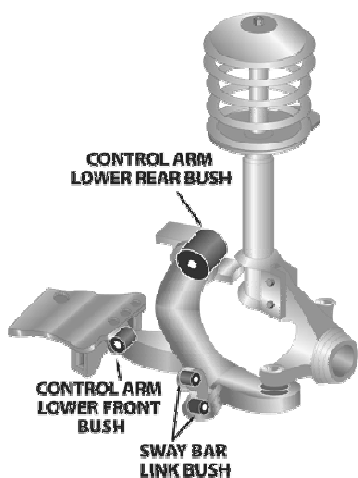
Página 1









Aplicaci...	Descripción	Referencia	Kits por...	Contenido del Kit	
TRAS.	Sway Bar Mount Bushing Measure bar diameter 14,16,17mm available	<b>MPU-0462-__K</b>	1	Bushings	
TRAS.	Trailing Arm - Bushing Kit	<b>MPU-0823K</b>	1	Inner Tubes, Bushings	 SPF0823K

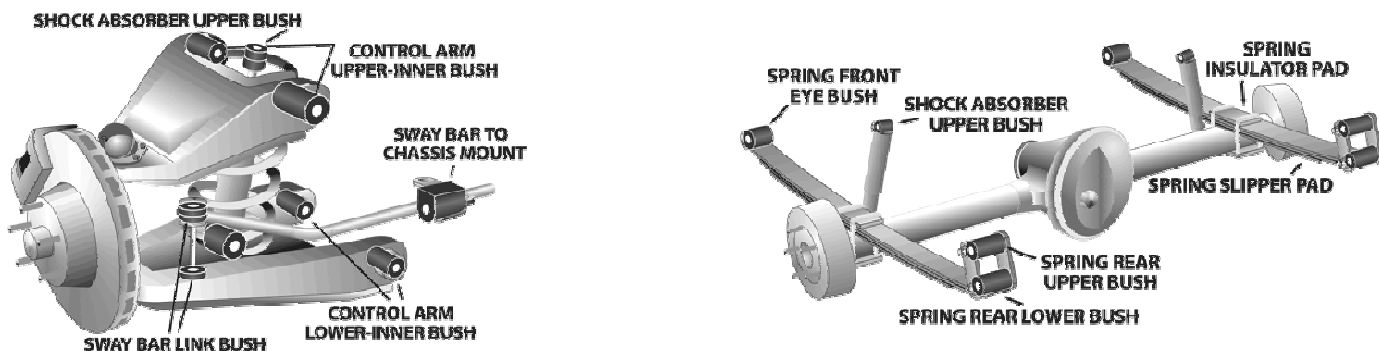

## TOYOTA Corona RT40 - 1964 - 1974

Página 1

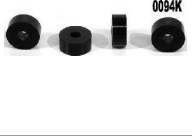







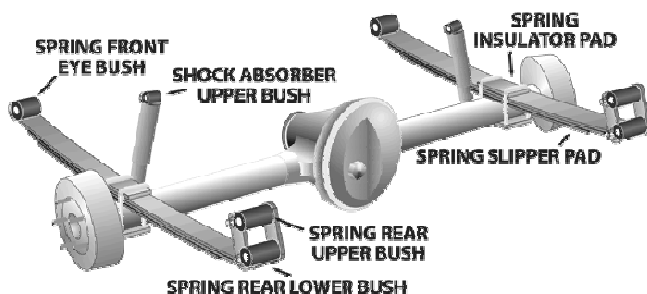
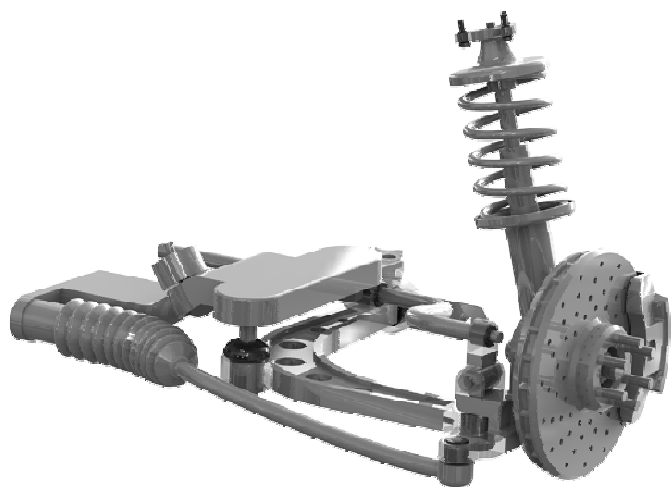

Aplicaci...	Descripción	Referencia	Kits por...	Contenido del Kit	
DEL.	Shock Absorber Upper Bushing	MPU-2092BK	1	Bushings	
DEL.	Sway Bar Link Bushing Kit	MPU-2092BK	1	Bushings	
TRAS.	Shock Absorber Lower Bushing	MPU-2178-16K	1	Bushings	
TRAS.	Shock Absorber Upper Bushing	MPU-0094K	1	Bushings	
TRAS.	Spring Front Eye Bushing	MPU-0891K	1	Bushings	
TRAS.	Spring Rear Bushing All	MPU-0583BK	1	Bushings	



TOYOTA Corona RT104, RT118 - 8/1973 - 5/1979

Página 1



Aplicaci...	Descripción	Referencia	Kits por...	Contenido del Kit	
DEL.	Control Arm Lower-Inner Bushing	<b>MPU-0867K</b>	1	Outer Shells, Inner Tubes, Bushings	
DEL.	Idler Arm Bushing 29mm OD 20mm ID	<b>MPU-0910K</b>	1	Bushings, Inner Tubes	
DEL.	Sway Bar Link Bushing Kit	<b>MPU-2092BK</b>	1	Bushings	
DEL.	Sway Bar Mount To Chassis Bushing Measure bar diameter 21,22,24mm available	<b>MPU-1285-__K</b>	1	Bushings	
TRAS.	Spring Front Eye Bushing Sedan only	<b>MPU-0911K</b>	1	Bushings	
TRAS.	Spring Rear Eye Bushing Sedan only	<b>MPU-0913K</b>	1	Bushings	
TRAS.	Spring Shackle Upper Bushing Sedan only	<b>MPU-0912K</b>	1	Bushings	





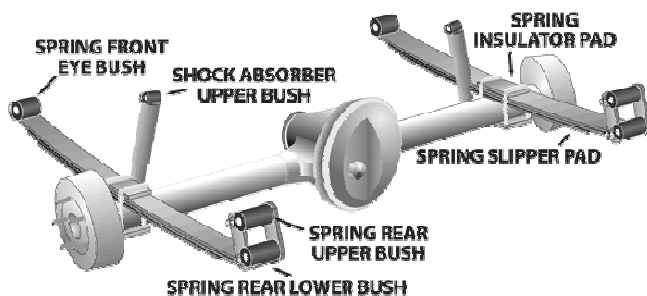
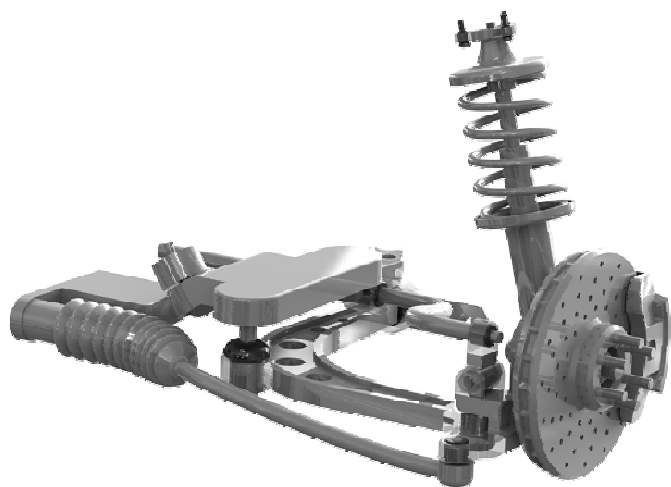

**TOYOTA Corona RT104, RT118 - 8/1973 - 5/1979**

Página 2 (Continúa)



Aplicaci...	Descripción	Referencia	Kits por...	Contenido del Kit	
TRAS.	Spring Shackle Upper Bushing	<b>MPU-1071K</b>	1	Bushings	



**TOYOTA Corona XT130, RT130 - 1979 - 1983**

Página 1

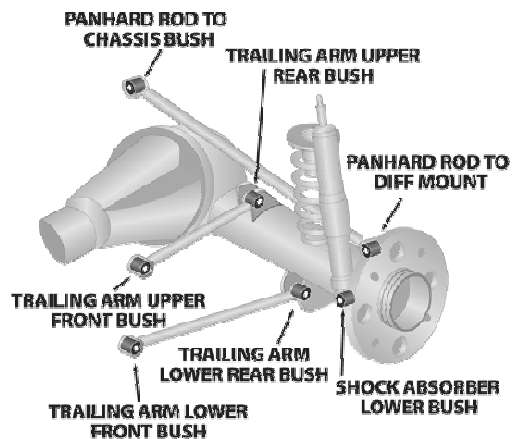
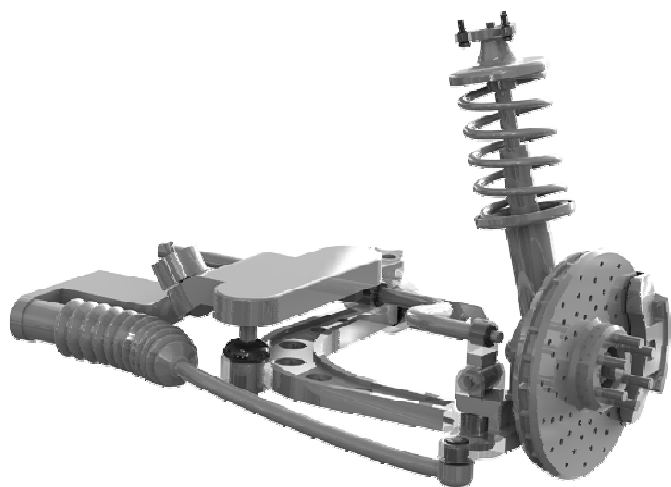

Aplicaci...	Descripción	Referencia	Kits por...	Contenido del Kit	
DEL.	Control Arm Lower-Inner Bushing Re-use original shell	<b>MPU-0509K</b>	1	Inner Tubes, Bushings	
DEL.	Strut Bar To Chassis Mount Kit	<b>MPU-0699-22K</b>	1	Bushings	
DEL.	Sway Bar Link Bushing Kit	<b>MPU-2092BK</b>	1	Bushings	
DEL.	Sway Bar Mount To Chassis Bushing Measure bar diameter 18,20,23mm available	<b>MPU-1233-__K</b>	1	Bushings	
TRAS.	Panhard Rod To Chassis Mount Kit Sedan	<b>MPU-0427K</b>	1	Bushings, Inner Tubes	
TRAS.	Panhard Rod To Diff Mount Bushing Sedan	<b>MPU-0963K</b>	1	Bushings, Inner Tubes	
TRAS.	Shock Absorber Lower Bushing	<b>MPU-2178-16K</b>	1	Bushings	



TOYOTA Corona XT130, RT130 - 1979 - 1983

Página 2 (Continúa)

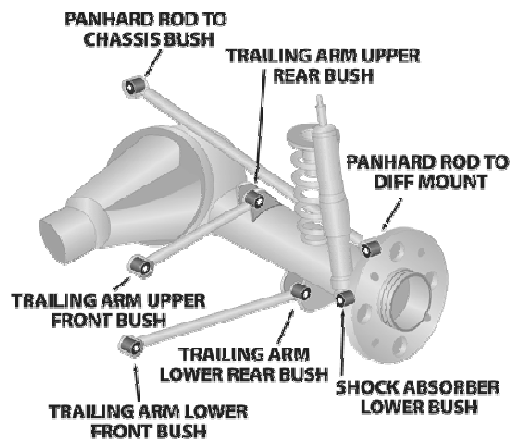
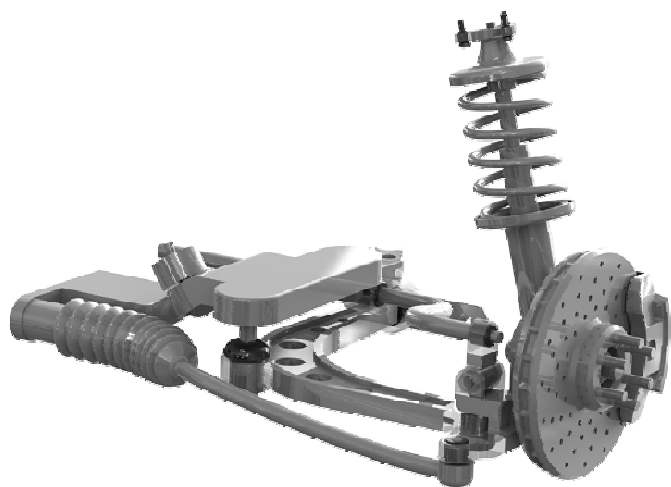

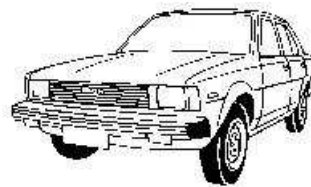

Aplicaci...	Descripción	Referencia	Kits por...	Contenido del Kit	
TRAS.	Shock Absorber Upper Bushing	MPU-2755SK	1	Bushings	
TRAS.	Spring Front Eye Bushing Station wagon	MPU-0911K	1	Bushings	
TRAS.	Spring Rear Eye Bushing Station wagon	MPU-0913K	1	Bushings	
TRAS.	Spring Shackle Upper Bushing Station wagon	MPU-0912K	1	Bushings	
TRAS.	Sway Bar Link Bushing Kit Sedan	MPU-2092BK	1	Bushings	
TRAS.	Sway Bar Mount To Axle Bushing Sedan, measure bar diameter 18,20,23mm available	MPU-1233-__K	1	Bushings	
TRAS.	Trailing Arm Lower Bushing All Sedan	MPU-0826K	1	Inner Tubes, Bushings	

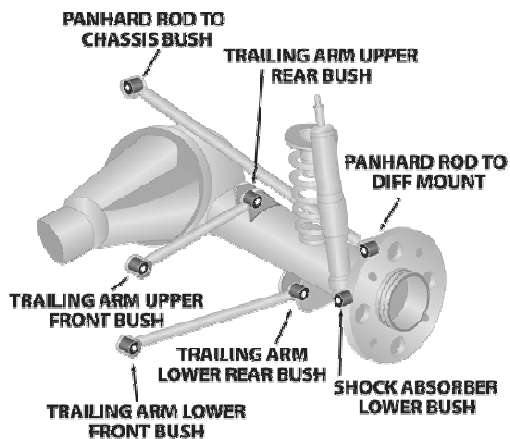
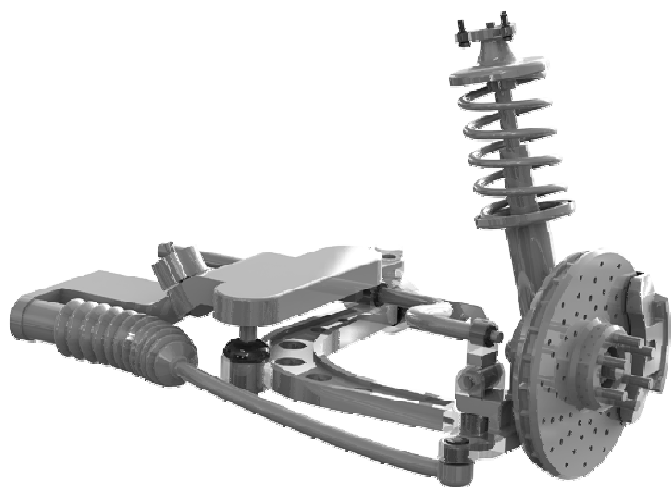

**TOYOTA Corona XT130, RT130 - 1979 - 1983**

Página 3 (Continúa)







Aplicaci...	Descripción	Referencia	Kits por...	Contenido del Kit	
TRAS.	Trailing Arm Upper Bushing All Sedan	<b>MPU-0826K</b>	1	Inner Tubes, Bushings	

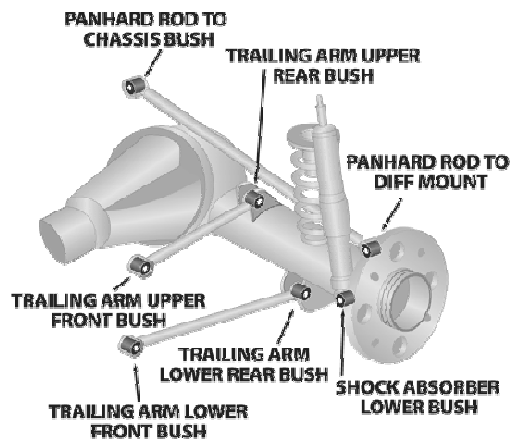
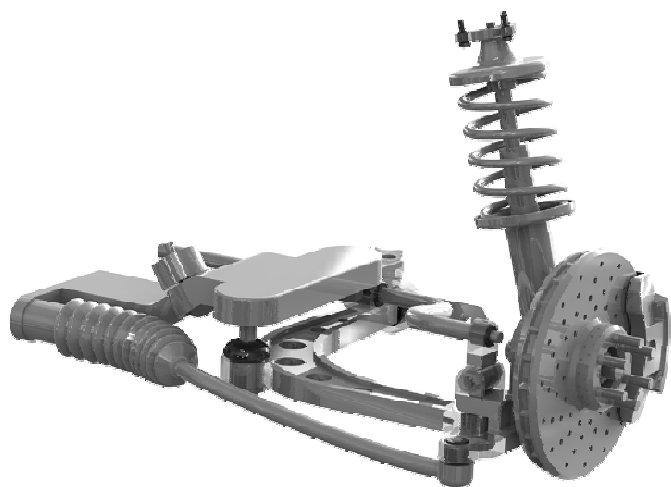

TOYOTA Cressida MX83 Sedan - 10/1988 - 1993

Página 1





Aplicaci...	Descripción	Referencia	Kits por...	Contenido del Kit	
DEL.	Strut Bar To Chassis Mount Kit Re use original washers	MPU-1324K	1	Inner Tubes, Bushings	
DEL.	Sway Bar Mount Bushing Measure bar diameter	MPU-1319-__K	1	Bushings	

**TOYOTA Cressida MX63,GX61X - 1982 - 1985**

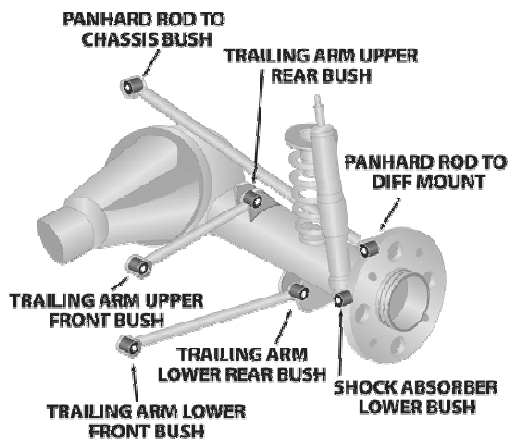
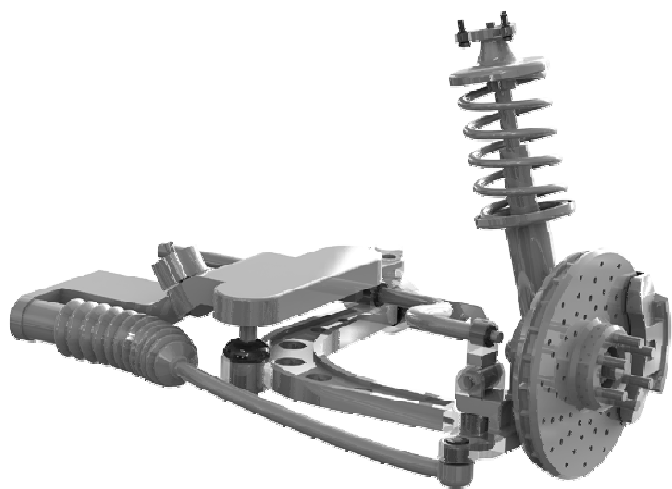
Página 1



Aplicaci...	Descripción	Referencia	Kits por...	Contenido del Kit	
TRAS.	Control Arm Lower-Inner & Outer Kit Remove OE shell for fitment, 70mm long tubes inner & 65mm tubes outer	<b>MPU-3180K</b>	1	Inner Tubes, Bushings	



TOYOTA Cressida MX32, MX62 - 12/1976 - 7/1984

Página 1

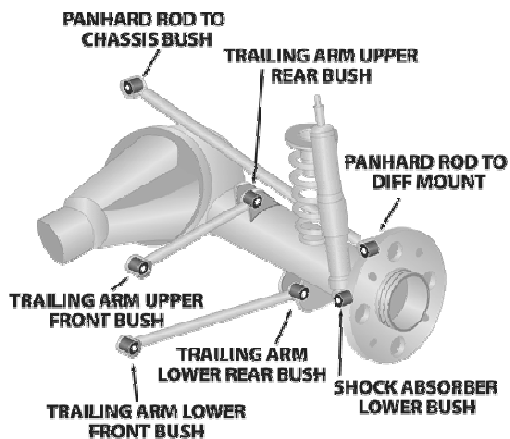
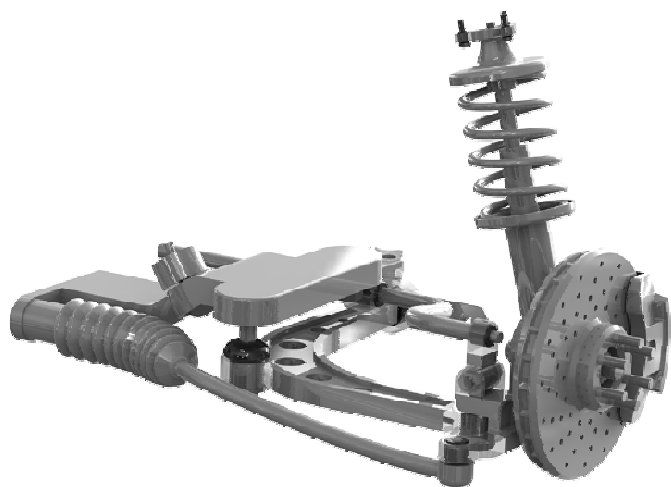

Aplicaci...	Descripción	Referencia	Kits por...	Contenido del Kit	
DEL.	Control Arm Lower-Inner Bushing Re-use original shell	MPU-0509K	1	Inner Tubes, Bushings	
DEL.	Idler Arm Bushing	MPU-1476K	1	Bushings, Inner Tubes	
DEL.	Strut Bar To Chassis Mount Kit	MPU-0152K	1	Bushings	
DEL.	Sway Bar Link Bushing Kit	MPU-0903K	1	Bushings	
DEL.	Sway Bar Mount To Chassis Bushing Measure bar diameter 21,22,24mm available	MPU-1285-__K	1	Bushings	
TRAS.	Panhard Rod To Chassis Mount Kit	MPU-0427K	1	Bushings, Inner Tubes	
TRAS.	Panhard Rod To Diff Mount Bushing	MPU-0963K	1	Bushings, Inner Tubes	



TOYOTA Cressida MX32, MX62 - 12/1976 - 7/1984

Página 2 (Continúa)

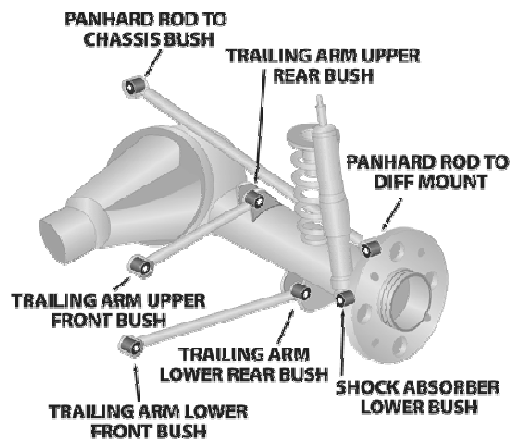
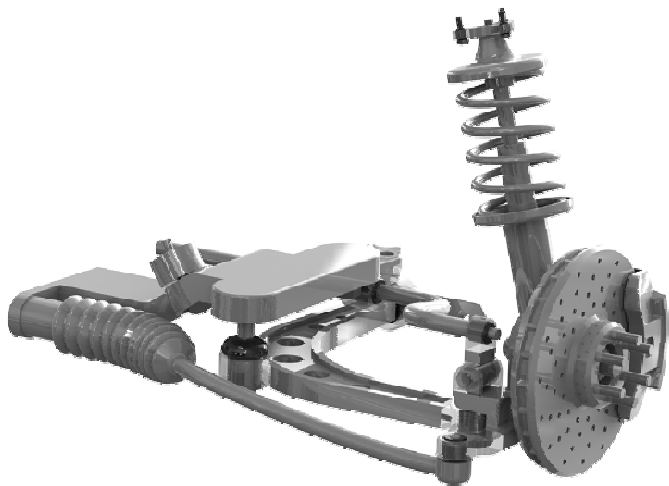

Aplicaci...	Descripción	Referencia	Kits por...	Contenido del Kit	
TRAS.	Shock Absorber Lower Bushing	MPU-2178-16K	1	Bushings	 SPF2178- K
TRAS.	Shock Absorber Upper Bushing	MPU-2755SK	1	Bushings	 SPF2755SK
TRAS.	Trailing Arm Lower Bushing All	MPU-0827K	1	Inner Tubes, Bushings	 0 8 2 7 K
TRAS.	Trailing Arm Upper Bushing All	MPU-0018K	1	Inner Tubes, Bushings	 0018K





TOYOTA Cressida MX73 Sedan - 10/1984 - 1988

Página 1

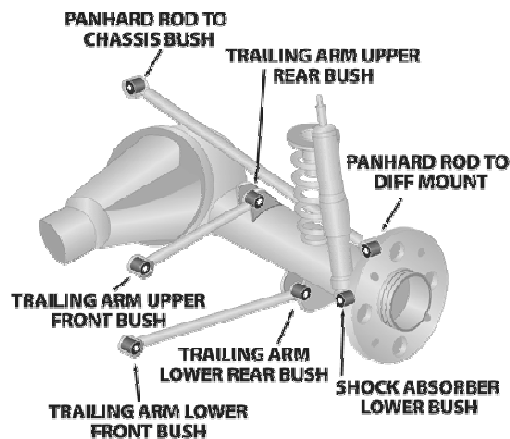
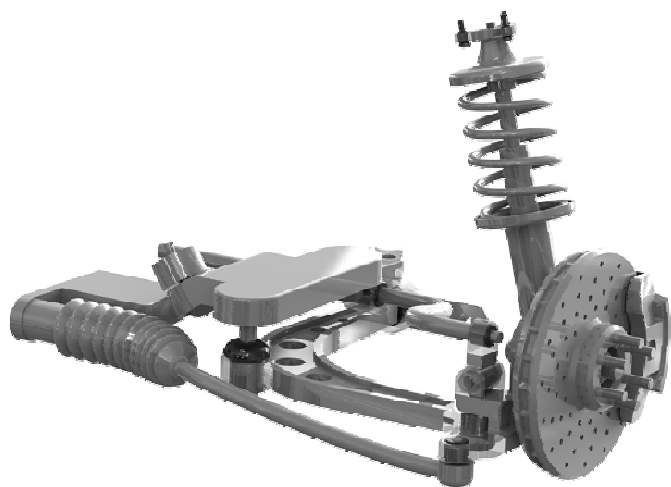





Aplicaci...	Descripción	Referencia	Kits por...	Contenido del Kit	
DEL.	Control Arm Lower-Inner Bushing Re-use original shell	MPU-0509K	1	Inner Tubes, Bushings	
DEL.	Sway Bar Link Bushing Kit	MPU-2755SK	1	Bushings	
DEL.	Sway Bar Mount To Chassis Bushing Measure bar diameter	MPU-1319-__K	1	Bushings	
TRAS.	Panhard Rod To Chassis Mount Kit	MPU-0427K	1	Bushings, Inner Tubes	
TRAS.	Panhard Rod To Diff Mount Bushing	MPU-0963K	1	Bushings, Inner Tubes	
TRAS.	Shock Absorber Lower Bushing	MPU-2178-16K	1	Bushings	
TRAS.	Sway Bar Link Bushing Kit	MPU-0903K	1	Bushings	

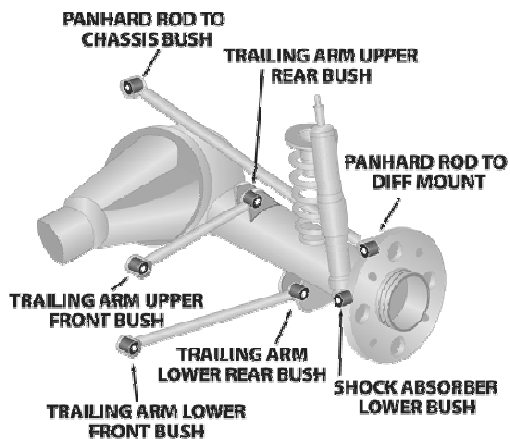
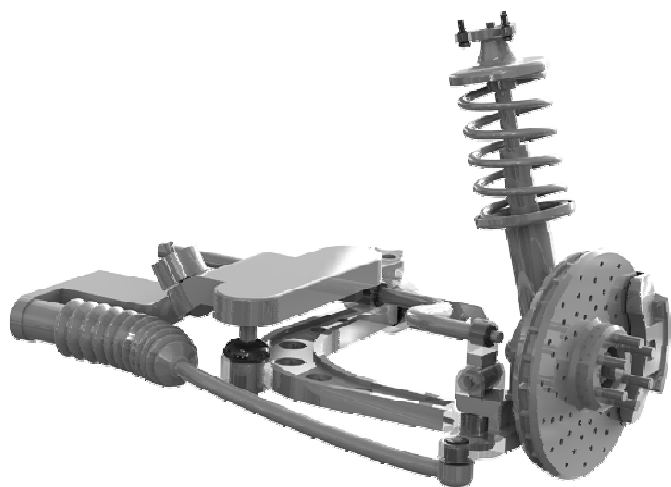

TOYOTA Cressida MX73 Sedan - 10/1984 - 1988

Página 2 (Continúa)



Aplicaci...	Descripción	Referencia	Kits por...	Contenido del Kit	
TRAS.	Sway Bar Mount To Chassis Bushing Measure bar diameter 16,18mm available	MPU-1446-__K	1	Bushings	
TRAS.	Trailing Arm Lower Bushing All Solid axle rear	MPU-0827K	1	Inner Tubes, Bushings	
TRAS.	Trailing Arm Upper Bushing All Solid axle rear	MPU-0826K	1	Inner Tubes, Bushings	



TOYOTA Crown MS55, 65, 75, 85, 95, 111, 112 - 9/1967 - 1983

Página 1

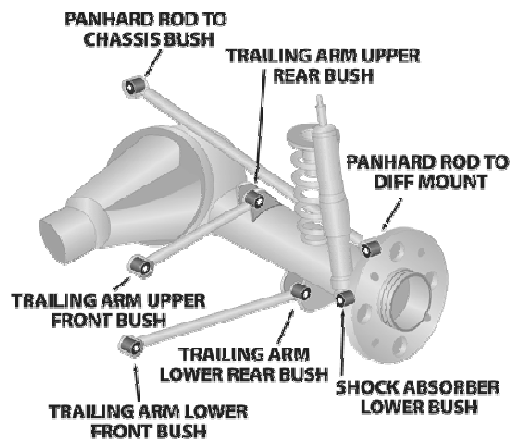
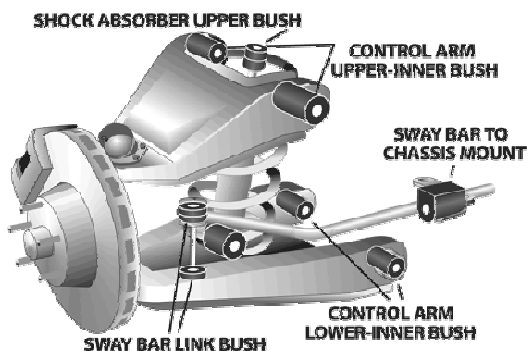







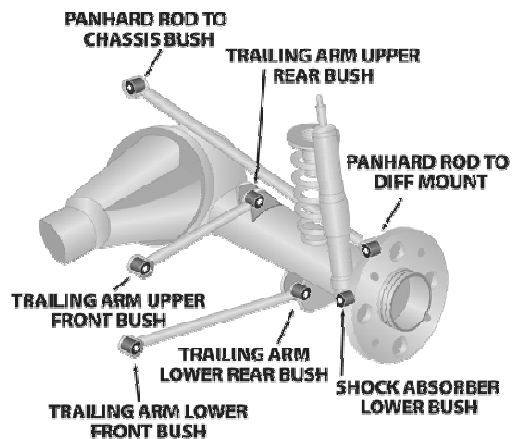
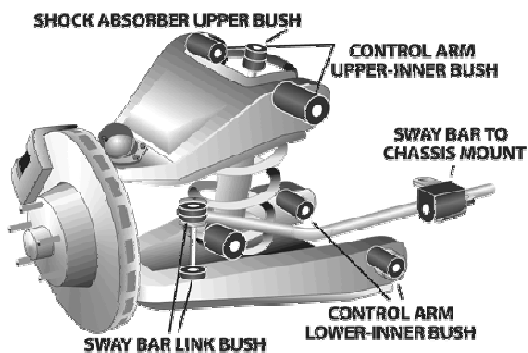

Aplicaci...	Descripción	Referencia	Kits por...	Contenido del Kit	
DEL.	Control Arm Lower-Inner Bushing 9/1979 to 9/1983	MPU-1129K	1	Bushings, Inner Tubes	
DEL.	Control Arm Upper-Inner Kit 9/1979 to 9/1983	MPU-1128K	1	Bushings, Inner Tubes, Outer Shells	
DEL.	Shock Absorber Upper Bushing	MPU-2755SK	1	Bushings	
DEL.	Strut Bar To Chassis Mount Kit	MPU-0699-22K	1	Bushings	
DEL.	Sway Bar Link Bushing Kit	MPU-2092BK	1	Bushings	
DEL.	Sway Bar Mount To Chassis Bushing Measure bar diameter 18,20,23mm available	MPU-1131-__K	1	Bushings	
TRAS.	Panhard Rod To Chassis Mount Kit	MPU-1075K	1	Bushings, Inner Tubes	



TOYOTA Crown MS55, 65, 75, 85, 95, 111, 112 - 9/1967 - 1983

Página 2 (Continúa)



Aplicaci...	Descripción	Referencia	Kits por...	Contenido del Kit	
TRAS.	Panhard Rod To Diff Mount Bushing	MPU-0963K	1	Bushings, Inner Tubes	
TRAS.	Shock Absorber Lower Bushing	MPU-2178-16K	1	Bushings	
TRAS.	Shock Absorber Upper Bushing	MPU-2755SK	1	Bushings	
TRAS.	Sway Bar Link Bushing Kit	MPU-0903K	1	Bushings	
TRAS.	Sway Bar Mount To Chassis Bushing Measure bar diameter 17,18,20,23mm available	MPU-1132-__K	1	Bushings	
TRAS.	Trailing Arm - Bushing Kit	MPU-1127K	1	Bushings, Inner Tubes	



## TOYOTA Crown S180 - 2003 - 2008

Página 1

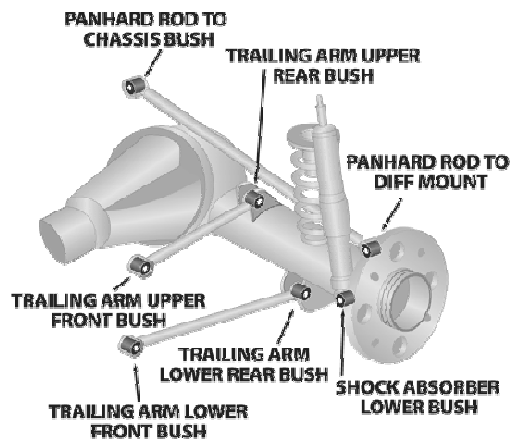
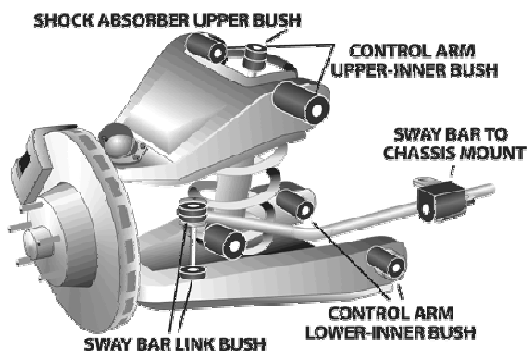

Aplicaci...	Descripción	Referencia	Kits por...	Contenido del Kit	
DEL.	Control Arm Lower Rear Bushing Single Offset.	<b>MPU-3675K</b>	1	Outer Shells, Inner Tubes, Bushings	
DEL.	Control Arm Lower Rear Bushing Double Offset.	<b>MPU-3692K</b>	1	Outer Shells, Inner Tubes, Bushings	
DEL.	Control Arm Lower Rear Bushing (Eccentric) Double Offset.	<b>MPU-3692-90K</b>	1	Inst Sheet, Outer Shells, Inner Tubes, Bushings	
DEL.	Control Arm Upper-Inner Bushing	<b>MPU-3507K</b>	1	Outer Shells, Inner Tubes, Bushings	
DEL.	Control Arm Upper-Inner Eccentric Kit Offset.	<b>MPU-3507XK</b>	1	Inst Sheet, Outer Shells, Inner Tubes, Bushings	
DEL.	Sway Bar Mount To Chassis Bushing Available in sizes - 24, 27, 28, 30 & 32.5mm.	<b>MPU-3584-__K</b>	1	Bushings	
TRAS.	Control Arm Lower-Inner Bushing	<b>MPU-3508K</b>	1	Outer Shells, Inner Tubes, Bushings	



## TOYOTA Crown S180 - 2003 - 2008

Página 2 (Continúa)

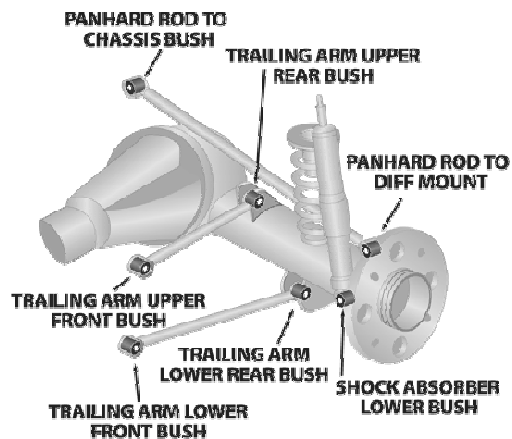
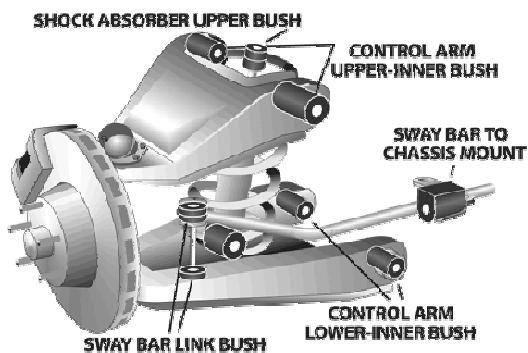





Aplicaci...	Descripción	Referencia	Kits por...	Contenido del Kit	
TRAS.	Sway Bar Mount To Chassis Bushing Available in sizes - 14, 15, 17, 18 & 19mm.	MPU-3494-__K	1	Bushings	
TRAS.	Toe Control Arm - Inner Bushing	MPU-3506K	1	Inner Tubes, Bushings	
TRAS.	Trailing Arm Lower Front Bushing	MPU-3503K	1	Inner Tubes, Bushings	
TRAS.	Trailing Arm Upper Front Bushing	MPU-3504K	1	Inner Tubes, Bushings	
TRAS.	Trailing Arm Upper Rear Bushing	MPU-3501K	1	Inner Tubes, Bushings	

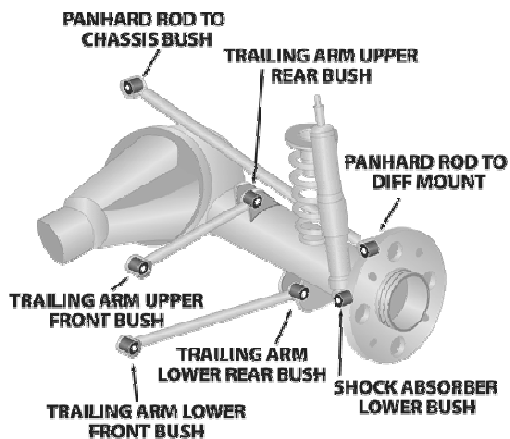
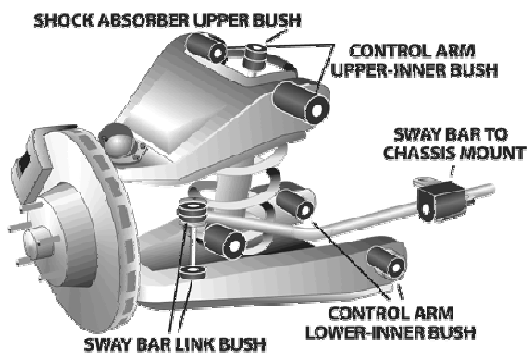

TOYOTA Crown MS123 Royal Sedan - 8/1983 - 5/1988

Página 1









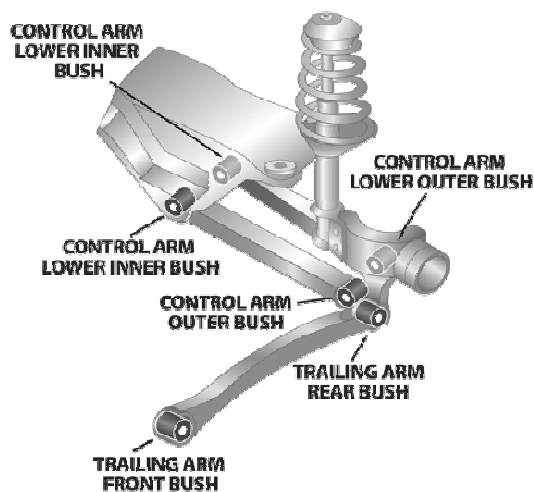
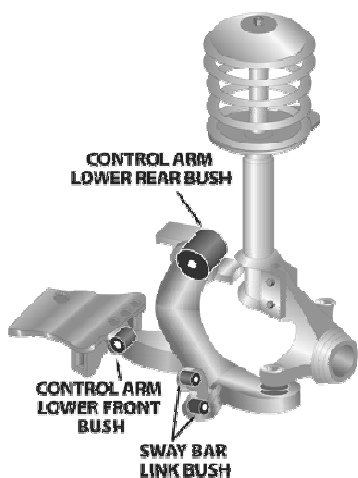

Aplicaci...	Descripción	Referencia	Kits por...	Contenido del Kit	
DEL.	Sway Bar Link Bushing Kit	MPU-2092BK	1	Bushings	
TRAS.	Shock Absorber Lower Bushing	MPU-2178-16K	1	Bushings	
TRAS.	Sway Bar Link Bushing Kit	MPU-0903K	1	Bushings	



## TOYOTA MR2 ZZW30 2 Door Coupe - 10/2000 - 2004

Página 1



Aplicaci...	Descripción	Referencia	Kits por...	Contenido del Kit	
DEL.	Control Arm Lower-Inner Front Kit Bushing to suit RH OE# 48068-19176 arm & LH OE# 48069-19156 arm, 12mm mounting bolt.	<b>MPU-2781K</b>	1	Inner Tubes, Bushings	 SPF2781K
DEL.	Control Arm Lower-Inner Rear Eccentric Performance Settings, 2 x offset bushings for castor adjustment	<b>MPU-2798K</b>	1	Outer Shells, Inner Tubes, Bushings	
DEL.	Control Arm Lower-Inner Rear Eccentric Alignment adjustment, 1 x offset & 1 x standard bushings for castor adjustment	<b>MPU-2797K</b>	1	Outer Shells, Inner Tubes, Bushings	
DEL.	Control Arm Lower-Inner Rear Kit Remove original shell for fitment, Replaces bushings in complete original assy RH = 48068-19176 LH...	<b>MPU-2782K</b>	1	Outer Shells, Inner Tubes, Bushings	
DEL.	Sway Bar Link To Lower Arm Bushing Must re-use all original washers	<b>MPU-2092B-4K</b>	1	Bushings	
DEL.	Sway Bar Mount To Chassis Bushing Measure bar diameter 20mm available, OE# 48818-17130	<b>MPU-2399-__K</b>	1	Bushings	
TRAS.	Control Arm Lower-Inner Bushing Replaces bush in original arm # 48710-17050	<b>MPU-2396K</b>	1	Bushings, Inner Tubes	







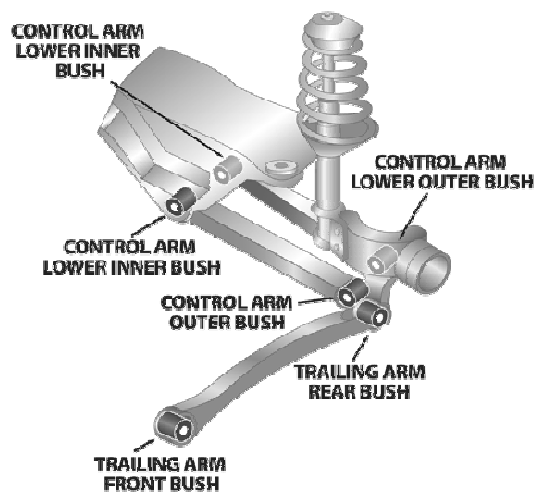
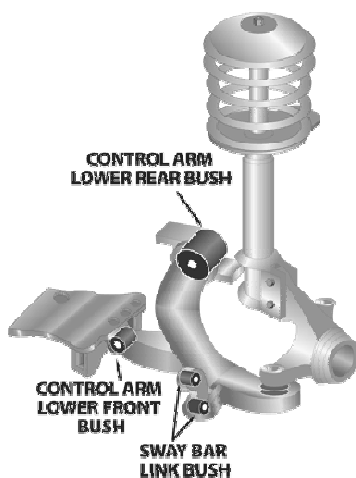

## TOYOTA MR2 ZZW30 2 Door Coupe - 10/2000 - 2004

Página 2 (Continúa)





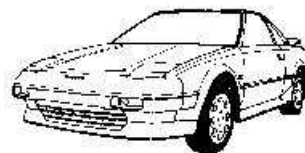



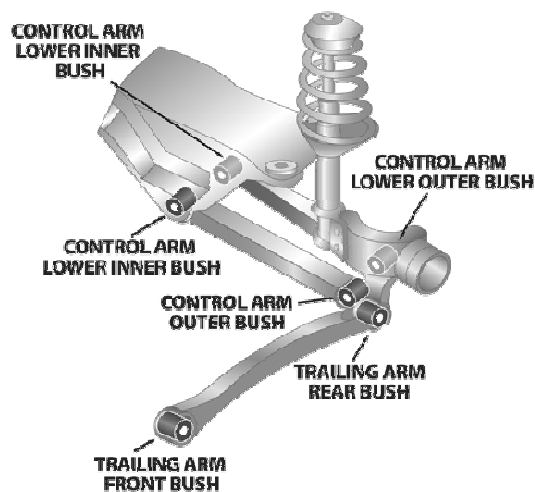
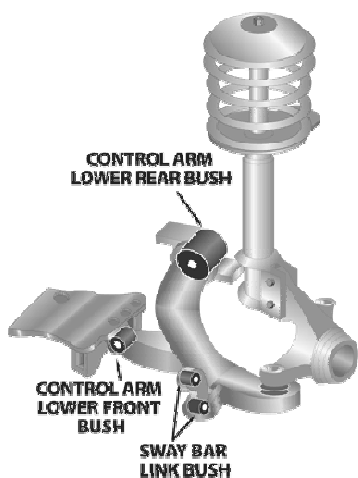

Aplicaci...	Descripción	Referencia	Kits por...	Contenido del Kit	
TRAS.	Sway Bar Mount To Chassis Bushing Measure bar diameter 15,18mm available,OE# 48815-17150	MPU-2400-__K	1	Bushings	
TRAS.	Toe Control Arm - Inner Bushing Replaces OE # 48725-17100, Or bushing for complete arm assy OE# 48730-17060	MPU-2395K	1	Inner Tubes, Bushings	
TRAS.	Trailing Arm Lower Bushing All Replaces bush in original arm # 48780-17050	MPU-2398K	1	Inner Tubes, Bushings	



## TOYOTA MR2 AW11 2 Door Coupe - 8/1987 - 12/1989

Página 1



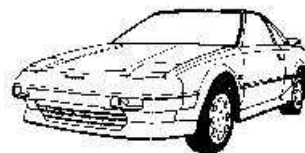

Aplicaci...	Descripción	Referencia	Kits por...	Contenido del Kit	
DEL.	Control Arm Lower-Inner Bushing 12mm mounting bolt	<b>MPU-1330-12K</b>	1	Inner Tubes, Bushings	
DEL.	Strut Bar To Chassis Mount Kit	<b>MPU-1332K</b>	1	Inner Tubes, Bushings	
DEL.	Sway Bar Link Bushing Kit	<b>MPU-2092BK</b>	1	Bushings	
DEL.	Sway Bar Mount To Chassis Bushing Replaces OE # 48815-17010, Measure bar diameter	<b>MPU-0660-__K</b>	1	Bushings	
TRAS.	Control Arm Lower-Inner Bushing	<b>MPU-1330-12K</b>	1	Inner Tubes, Bushings	
TRAS.	Sway Bar Mount To Chassis Bushing Replaces OE # 48818-17050,17060, Measure bar diameter 10,12,13,14,18,19mm available	<b>MPU-1333-__K</b>	1	Bushings	
TRAS.	Trailing Arm Lower Front Bushing	<b>MPU-0823-4K</b>	1	Bushings, Inner Tubes	

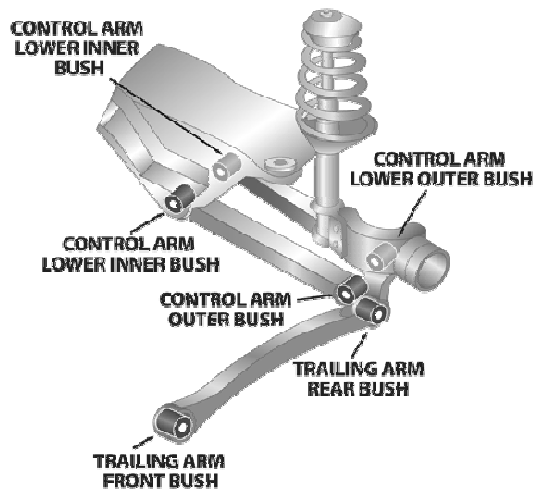
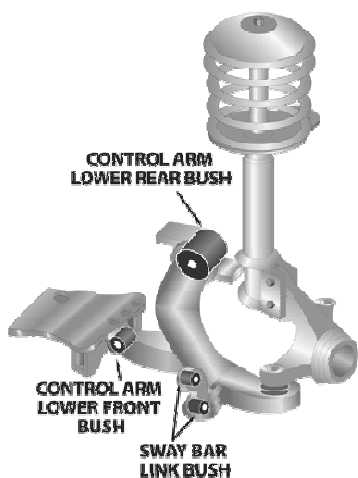

**TOYOTA MR2 AW11 2 Door Coupe - 8/1987 - 12/1989**

Página 2 (Continúa)









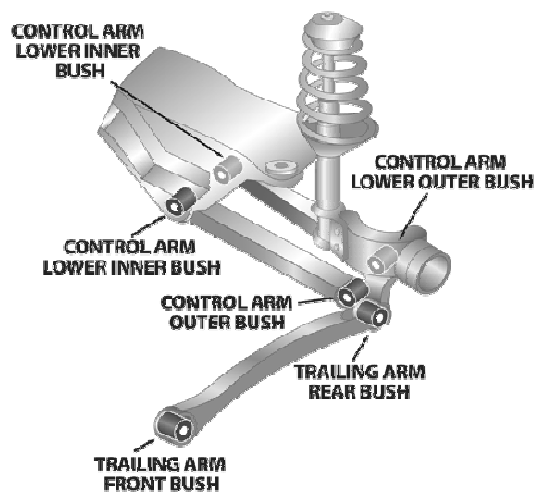
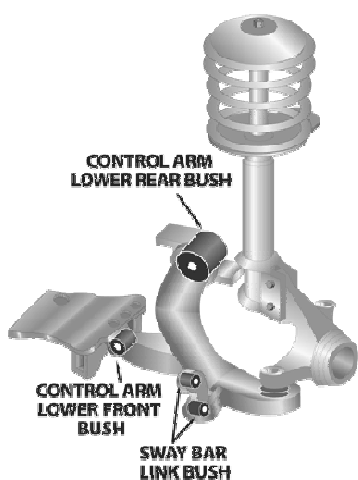

Aplicaci...	Descripción	Referencia	Kits por...	Contenido del Kit	
TRAS.	Trailing Arm Lower Rear Bushing	<b>MPU-1332K</b>	1	Inner Tubes, Bushings	 1 3 3 2 K



## TOYOTA MR2 SW20 2 Door Coupe - 12/1989 - 12/1999

Página 1









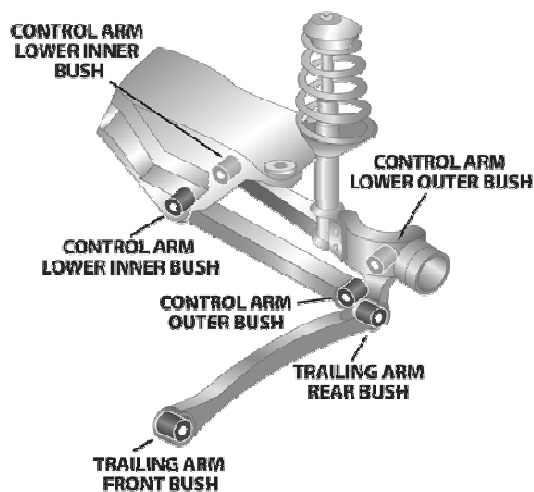
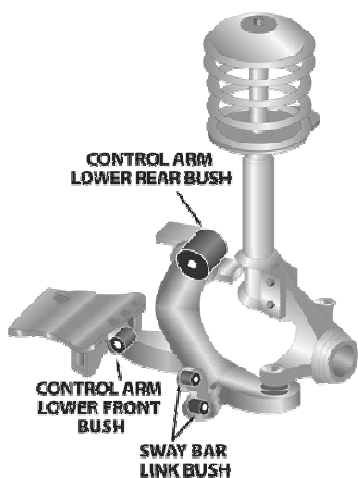

Aplicaci...	Descripción	Referencia	Kits por...	Contenido del Kit	
DEL.	Control Arm Lower-Inner Bushing	<b>MPU-1330-12K</b>	1	Inner Tubes, Bushings	
DEL.	Strut Bar To Chassis Mount Kit 1990 Only	<b>MPU-1332K</b>	1	Inner Tubes, Bushings	
DEL.	Strut Bar To Chassis Mount Kit Rev2 & On vehicles, Replaces original shell part. Standard Replacement	<b>MPU-2942K</b>	1	Inner Tubes, Bushings	
DEL.	Strut Bar To Chassis Mount-Adjustable Bushing Rev2 & On vehicles, Replaces original shell part. 1 x Standard & 1 x offset 0.75 degree...	<b>MPU-3206K</b>	1	Inner Tubes, Bushings	
DEL.	Strut Bar To Chassis Mount-Adjustable Bushing Rev2 & On vehicles, Replaces original shell part. 2 x offset 1.50 degree castor change.	<b>MPU-3207K</b>	1	Inner Tubes, Bushings	
DEL.	Sway Bar Link Bushing Kit	<b>MPU-2092BK</b>	1	Bushings	
DEL.	Sway Bar Mount To Chassis Bushing 12/89-12/91 Replaces OE# 48815-17010,17050,17060	<b>MPU-0660-__K</b>	1	Bushings	



## TOYOTA MR2 SW20 2 Door Coupe - 12/1989 - 12/1999

Página 2 (Continúa)









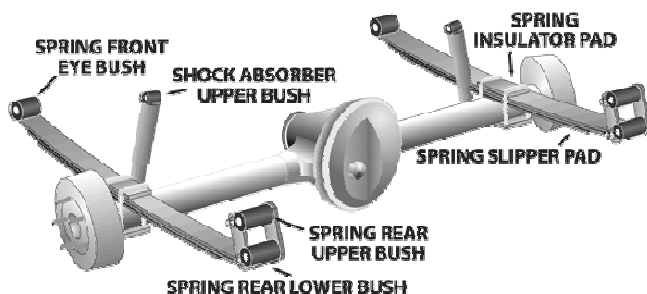
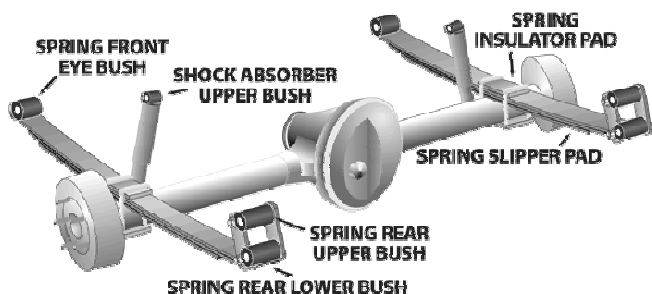

Aplicaci...	Descripción	Referencia	Kits por...	Contenido del Kit	
DEL.	Sway Bar Mount To Chassis Bushing 12/9 - 8/99 17.5,17.8,20mm Rep OE# 48815-17100,17120	MPU-2377-__K	1	Bushings	
TRAS.	Control Arm Lower-Inner Bushing Suited to 14mm mount bolt	MPU-1330-14K	1	Bushings, Inner Tubes	
TRAS.	Engine, Cushion, Front Stabilizer Replaces OE#90948-01003	MPU-0729-2K	1	Bushings	
TRAS.	Sway Bar Mount To Chassis Bushing 12/89 - 12/91 Replaces OE# 48818-17080,17081	MPU-0661-__K	1	Bushings	
TRAS.	Sway Bar Mount To Chassis Bushing 12/91- 8/99 19,20mm Rep OE# 48818-17110,17111	MPU-2378-__K	1	Bushings	
TRAS.	Trailing Arm - Front Bushing	MPU-0823-4K	1	Bushings, Inner Tubes	
TRAS.	Trailing Arm - Rear Bushing Re-use original inner crush tube	MPU-0699-22K	1	Bushings	



TOYOTA Blizzard LD10 - 3/1982 - 7/1983

Página 1





Aplicaci...	Descripción	Referencia	Kits por...	Contenido del Kit	
DEL.	Shock Absorber Upper / Lower Bushing	MPU-2178-16K	2	Bushings	
DEL.	Spring Front Eye Bushing	MPU-0316K	1	Inner Tubes, Bushings	
DEL.	Spring Front Upper Bushing	MPU-0317K	1	Bushings	
DEL.	Spring Rear Eye Bushing	MPU-0315K	1	Bushings	
TRAS.	Shock Absorber Upper / Lower Bushing	MPU-2178-16K	2	Bushings	
TRAS.	Spring Front Eye Bushing	MPU-0315K	1	Bushings	
TRAS.	Spring Rear Eye Bushing	MPU-0316K	1	Inner Tubes, Bushings	

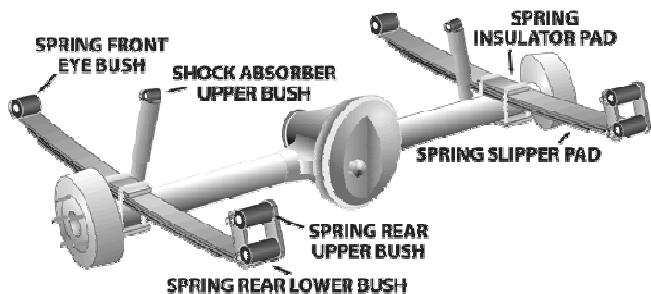
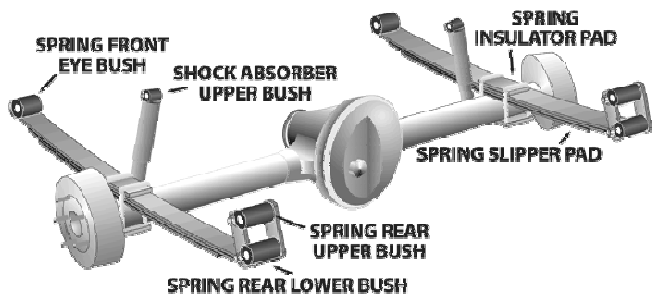

**TOYOTA Blizzard LD10 - 3/1982 - 7/1983**

Página 2 (Continúa)



Aplicaci...	Descripción	Referencia	Kits por...	Contenido del Kit	
TRAS.	Spring Shackle Upper Bushing	<b>MPU-0317K</b>	1	Bushings	



## TOYOTA Landcruiser 45 & 47 Series - 1972 - 1984

Página 1

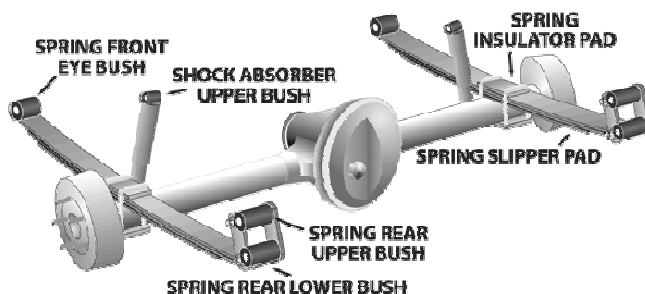
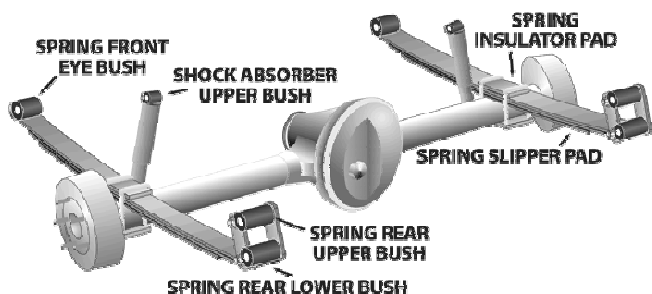

Aplicaci...	Descripción	Referencia	Kits por...	Contenido del Kit	
DEL.	Leaf Spring Bushing All 1972 to 7/1980 only, "H" Kits for H/D applications	<b>MPU-2230HK</b>	1	Bushings	
DEL.	Leaf Spring Bushing All 1972 to 7/1980 only, OE	<b>MPU-2230K</b>	1	Bushings	
DEL.	Leaf Spring Bushing All 7/1980 on only, "H" Kits for H/D applications, New design to suit greasable shackles	<b>MPU-2260HK</b>	1	Bushings	
DEL.	Leaf Spring Bushing All 7/1980 on only, OE	<b>MPU-2260K</b>	1	Bushings	
DEL.	Shock Absorber Upper / Lower Bushing	<b>MPU-2178-16K</b>	2	Bushings	
DEL.	Spring Slipper Pad Bushing	<b>MPU-1419K</b>	1	Bushings	
DEL.	Sway Bar Link Bushing Kit	<b>MPU-2092BK</b>	1	Bushings	









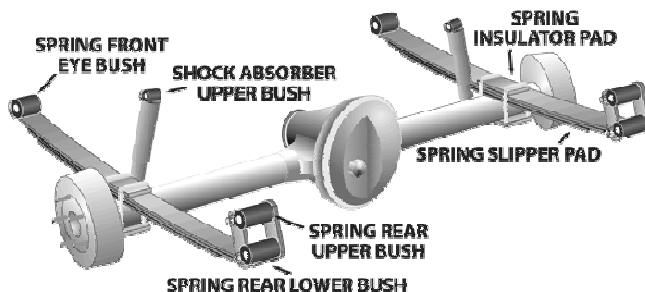
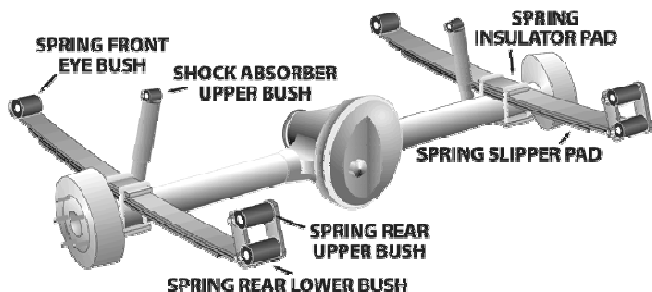



## TOYOTA Landcruiser 45 & 47 Series - 1972 - 1984

Página 2 (Continúa)



Aplicaci...	Descripción	Referencia	Kits por...	Contenido del Kit	
DEL.	Sway Bar Mount To Chassis Bushing Measure bar diameter 14 to 27mm available	MPU-0605-__K	1	Bushings	
F & R	Leaf Spring Bushing All 1972 to 7/1980 only, SPF2230K x 1, SPF2231AK x 1	MPK-023K	1		
F & R	Leaf Spring Bushing All 7/1980 on only, SPF2260K x 2	MPK-027K	1		
F & R	Leaf Spring Bushing All 1972 to 7/1980 only, "H" Kits for H/D applications	MPK-028HK	1		
F & R	Leaf Spring Bushing All 7/1980 on only, "H" Kits for H/D applications	MPK-036HK	1		
TRAS.	Leaf Spring Bushing All 1972 to 7/1980 only, "H" Kits for H/D applications	MPU-2231AHK	1	Bushings	
TRAS.	Leaf Spring Bushing All 1972 to 7/1980 only, OE	MPU-2231AK	1	Bushings	 2 2 3 1 AK



## TOYOTA Landcruiser 45 & 47 Series - 1972 - 1984

Página 3 (Continúa)

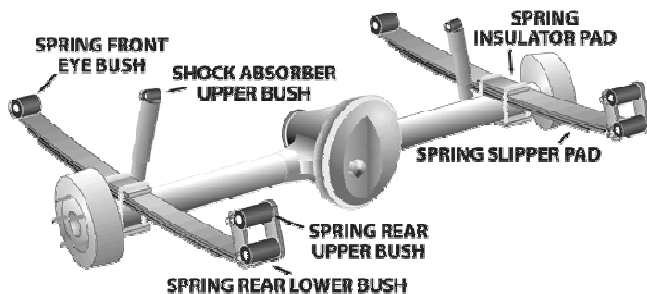
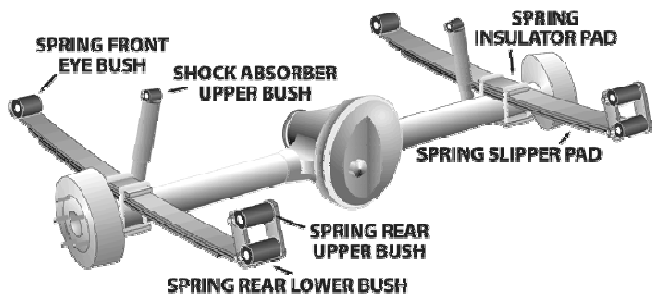

Aplicaci...	Descripción	Referencia	Kits por...	Contenido del Kit	
TRAS.	Leaf Spring Bushing All 7/1980 on only "H" Kits for H/D applications, New design to suit greasable shackles	<b>MPU-2260HK</b>	1	Bushings	
TRAS.	Leaf Spring Bushing All 7/1980 on only, OE	<b>MPU-2260K</b>	1	Bushings	
TRAS.	Shock Absorber Upper / Lower Bushing 7/1980 on only	<b>MPU-0078K</b>	2	Bushings	
TRAS.	Shock Absorber Upper / Lower Bushing 1972 to 7/1980 only	<b>MPU-2178-16K</b>	2	Bushings	
TRAS.	Spring Slipper Pad Bushing	<b>MPU-1419K</b>	1	Bushings	
TRAS.	Sway Bar Link Bushing Kit	<b>MPU-0280K</b>	2	Inner Tubes, Bushings	
TRAS.	Sway Bar Mount To Chassis Bushing Measure bar diameter 20,22,24,26mm available	<b>MPU-0105-__K</b>	1	Bushings	

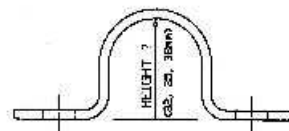

## TOYOTA Landcruiser 80 Series, Wagon - 5/1990 - 3/1998

Página 1

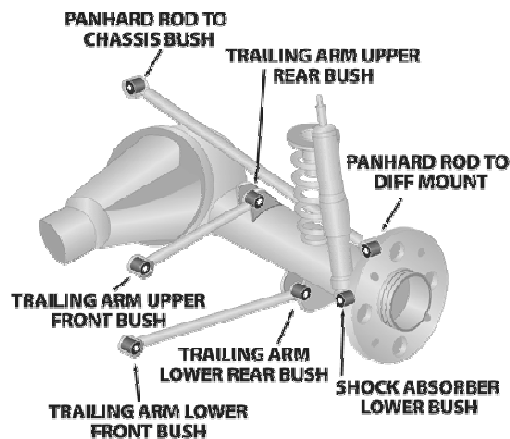
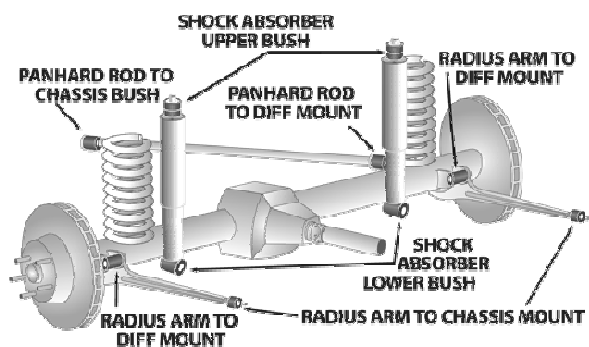



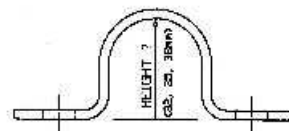



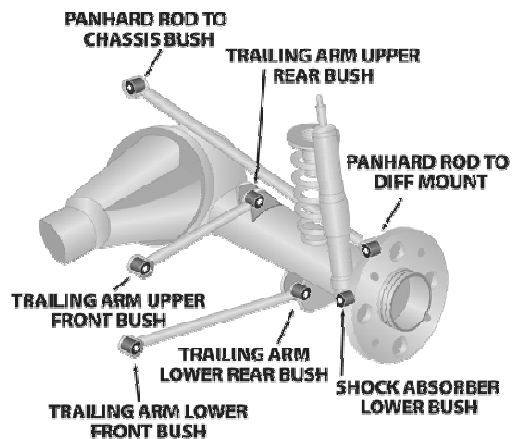
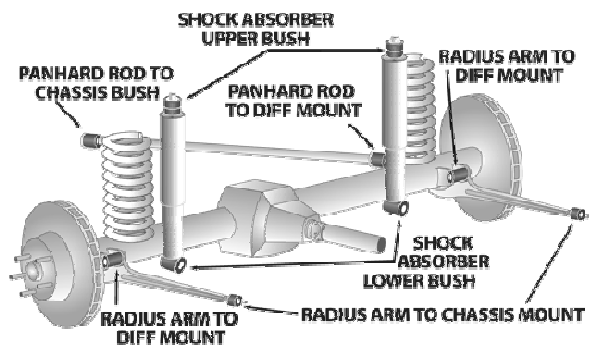

Aplicaci...	Descripción	Referencia	Kits por...	Contenido del Kit	
DEL.	Coil Spring Spacer Bushing Raises vehicle approximately 30mm	<b>MPU-0962K</b>	2	Bushings	
DEL.	Coil Spring Spacer Bushing Raises vehicle approximately 20mm	<b>MPU-1725K</b>	2	Bushings	
DEL.	Coil Spring Spacer Bushing Raises vehicle approximately 5mm	<b>MPU-1726-5K</b>	2	Bushings	
DEL.	Coil Spring Spacer Bushing Raises vehicle approximately 10mm	<b>MPU-1726K</b>	2	Bushings	
DEL.	Panhard Rod Bushing Remove original shell	<b>MPU-0445K</b>	1	Inner Tubes, Bushings	
DEL.	Radius Arm To - Diff Mount - Eccentric Kit Offset centre hole to increase caster settings	<b>MPU-1721K</b>	1	Inst Sheet, Outer Shells, Inner Tubes, Bushings	
DEL.	Radius Arm To - Diff Mount - Eccentric Kit Extra offset "High Lift Vehicles" To increase caster settings	<b>MPU-1721XK</b>	1	Inst Sheet, Outer Shells, Inner Tubes, Bushings	



## TOYOTA Landcruiser 80 Series, Wagon - 5/1990 - 3/1998

Página 2 (Continúa)





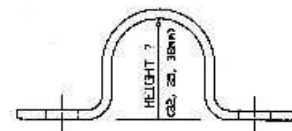



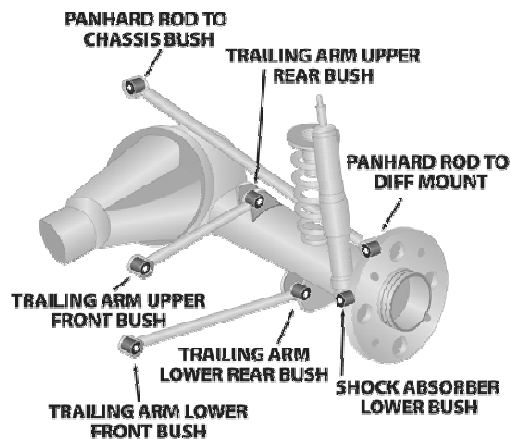
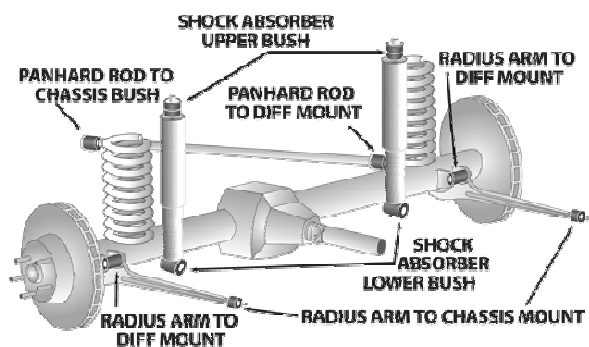

Aplicaci...	Descripción	Referencia	Kits por...	Contenido del Kit	
DEL.	Radius Arm To - Diff Mount Bushing	<b>MPU-0396K</b>	1	Inner Tubes, Bushings	 SPF0396K
DEL.	Radius Arm To Chassis Mount Bushing	<b>MPU-0440K</b>	1	Inner Tubes, Bushings	 SPF0440K
DEL.	Shock Absorber Upper / Lower Bushing	<b>MPU-0740K</b>	2	Bushings	 0740K
DEL.	Sway Bar Link Lower Bushing	<b>MPU-0280K</b>	1	Inner Tubes, Bushings	 SPF0280K
DEL.	Sway Bar Link To Chassis Bushing Up to 10/1992	<b>MPU-2755SK</b>	1	Bushings	 SPF2755SK
DEL.	Sway Bar Mount to Link Bushing Only suits 32mm original bracket height, please supply bar size	<b>MPU-0605-__K</b>	1	Bushings	
DEL.	Sway Bar Mount to Link Bushing Only suits 38mm original bracket height, please supply bar size; Measure bar diameter...	<b>MPU-1155-__K</b>	1	Bushings	 1155-__K



## TOYOTA Landcruiser 80 Series, Wagon - 5/1990 - 3/1998

Página 3 (Continúa)





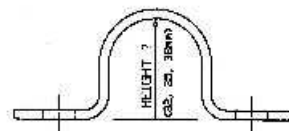



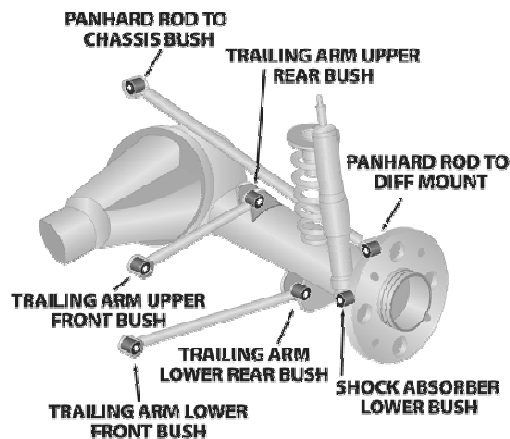
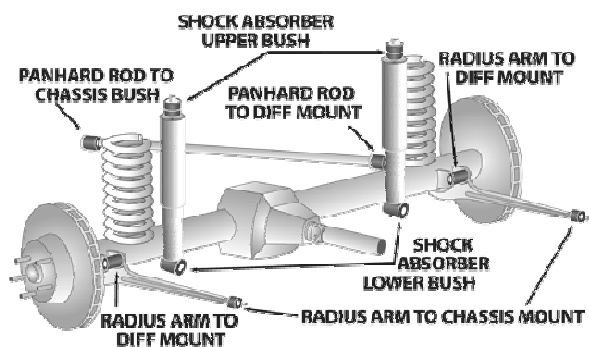

Aplicaci...	Descripción	Referencia	Kits por...	Contenido del Kit	
DEL.	available.	MPU-1155-__K	1	Bushings	
DEL.	Sway Bar Mount to Link Bushing Only suits 35mm original bracket height, please supply bar size	MPU-1450-__K	1	Bushings	
F & R	Radius Arms & Panhard Rods Bush Kit Extra adjust front radius arm to diff mount bushes included in this kit	MPK-058ADJXK	1		
F & R	Radius Arms & Panhard Rods Bush Kit Adjustable front radius arm bushings in kit	MPK-058ADJK	1		
F & R	Radius Arms & Panhard Rods Bush Kit Standard bushes to front radius arms, Kit will complete front and rear of the vehicle	MPK-058K	1		
TRAS.	Coil Spring Spacer Bushing Raises vehicle approximately 10mm	MPU-1724-10K	2	Bushings	
TRAS.	Coil Spring Spacer Bushing Raises vehicle approximately 15mm	MPU-1724-15K	2	Bushings	



## TOYOTA Landcruiser 80 Series, Wagon - 5/1990 - 3/1998

Página 4 (Continúa)



Aplicaci...	Descripción	Referencia	Kits por...	Contenido del Kit	
TRAS.	Coil Spring Spacer Bushing Raises vehicle approximately 30mm	<b>MPU-1724-30K</b>	2	Bushings	
TRAS.	Coil Spring Spacer Bushing Raises vehicle approximately 20mm	<b>MPU-1724-20K</b>	2	Bushings	
TRAS.	Panhard Rod Bushing	<b>MPU-0439K</b>	1	Bushings, Inner Tubes	
TRAS.	Shock Absorber Lower Bushing	<b>MPU-0078K</b>	1	Bushings	
TRAS.	Shock Absorber Upper Bushing	<b>MPU-0740K</b>	1	Bushings	
TRAS.	Sway Bar End Link Bushing	<b>MPU-0280K</b>	1	Inner Tubes, Bushings	
TRAS.	Sway Bar Link Upper Bushing Up to 10/1992	<b>MPU-2755SK</b>	1	Bushings	

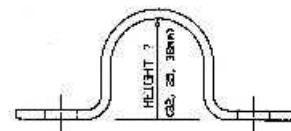

## TOYOTA Landcruiser 80 Series, Wagon - 5/1990 - 3/1998

Página 5 (Continúa)

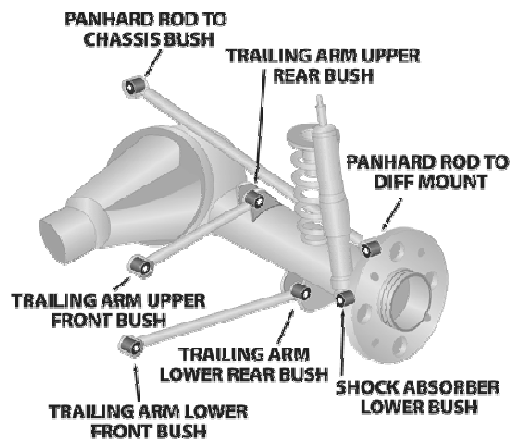
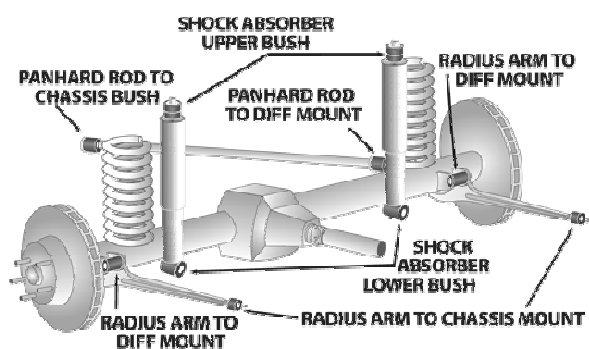







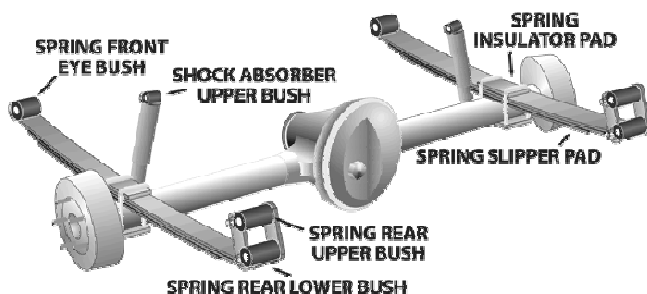
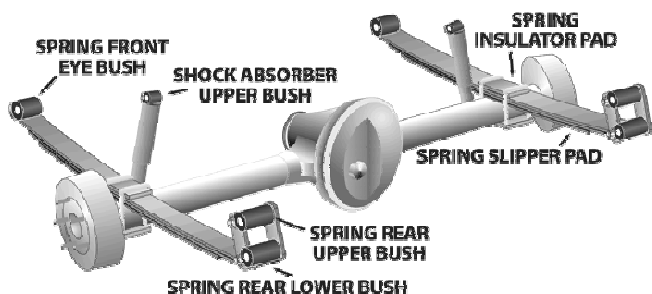

Aplicaci...	Descripción	Referencia	Kits por...	Contenido del Kit	
TRAS.	Sway Bar Mount To Chassis Bushing Only suits 32mm original bracket height, please supply bar size	<b>MPU-0605-__K</b>	1	Bushings	
TRAS.	Sway Bar Mount To Chassis Bushing Only suits 38mm original bracket height, please supply bar size; Measure bar diameter 20,22,23,24,25,26,27,28,29,30,31,32,34mm...	<b>MPU-1155-__K</b>	1	Bushings	
TRAS.	Sway Bar Mount To Chassis Bushing Only suits 35mm original bracket height, please supply bar size	<b>MPU-1450-__K</b>	1	Bushings	
TRAS.	Trailing Arm Lower Bushing All	<b>MPU-0441K</b>	2	Inner Tubes, Bushings	
TRAS.	Trailing Arm Upper Bushing All	<b>MPU-0442K</b>	2	Inner Tubes, Bushings	



**TOYOTA Landcruiser 71 Series HZJ71 SWB Short Wheel Base -**

Página 1



Aplicaci...	Descripción	Referencia	Kits por...	Contenido del Kit	
DEL.	Coil Spring Spacer Bushing	<b>MPU-0252-10K</b>	2	Bushings	
DEL.	Coil Spring Spacer Bushing	<b>MPU-0252-3K</b>	2	Bushings	
DEL.	Coil Spring Spacer Bushing	<b>MPU-0252-6K</b>	2	Bushings	
DEL.	Panhard Rod Bushing Remove original shell	<b>MPU-0445K</b>	1	Inner Tubes, Bushings	
DEL.	Radius Arm To - Diff Mount - Eccentric Kit Offset centre hole to increase caster settings	<b>MPU-1721K</b>	1	Inst Sheet, Outer Shells, Inner Tubes, Bushings	
DEL.	Radius Arm To - Diff Mount - Eccentric Kit Extra offset "High Lift Vehicles" To increase caster settings	<b>MPU-1721XK</b>	1	Inst Sheet, Outer Shells, Inner Tubes, Bushings	
DEL.	Radius Arm To - Diff Mount Bushing	<b>MPU-0396K</b>	1	Inner Tubes, Bushings	









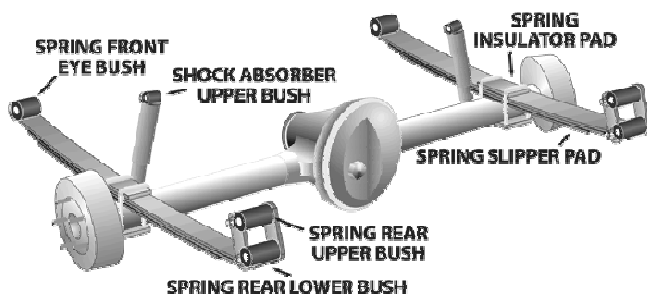
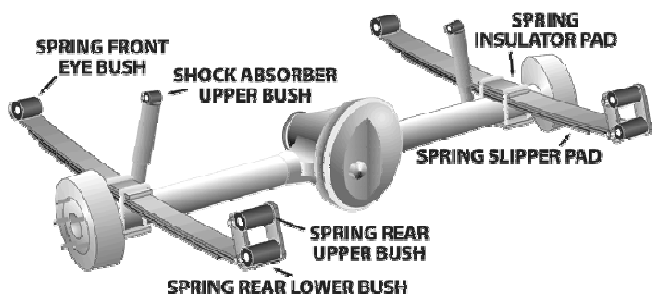

**TOYOTA Landcruiser 71 Series HZJ71 SWB Short Wheel Base -**

Página 2 (Continúa)









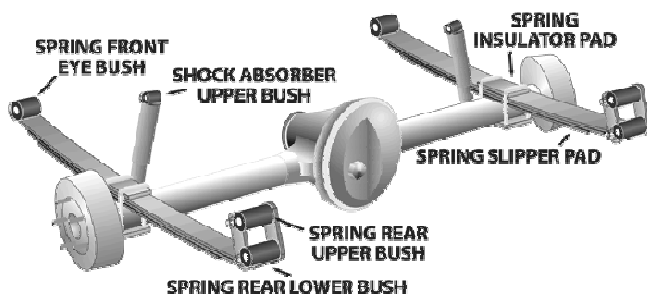
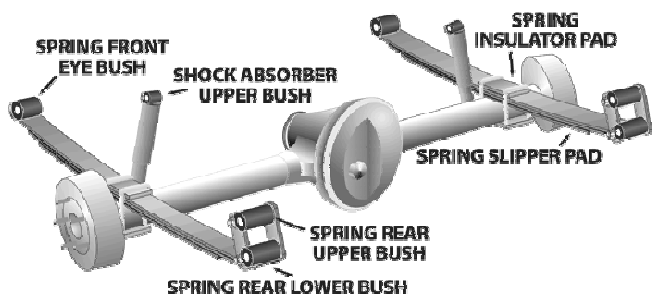

Aplicaci...	Descripción	Referencia	Kits por...	Contenido del Kit	
DEL.	Radius Arm To Chassis Mount Bushing	<b>MPU-0440K</b>	1	Inner Tubes, Bushings	
DEL.	Radius Arms & Panhard Rods Bush Kit Complete front kit, Includes adjustable radius arm bushes	<b>MPK-085ADJK</b>	1		
DEL.	Radius Arms & Panhard Rods Bush Kit Complete front kit, includes standard radius arm bushes	<b>MPK-085K</b>	1		
DEL.	Shock Absorber Upper / Lower Bushing	<b>MPU-0740K</b>	2	Bushings	
DEL.	Sway Bar End Link Bushing	<b>MPU-2147K</b>	1	Inner Tubes, Bushings	
DEL.	Sway Bar Mount to Link Bushing Only suits 38mm original bracket height, see picture above, please supply bar size; Measure bar diameter 20,22,23,24,25,26,27,28,29,30,31,32,34mm	<b>MPU-1155-__K</b>	1	Bushings	



TOYOTA Landcruiser 71 Series HZJ71 SWB Short Wheel Base -

Página 3 (Continúa)









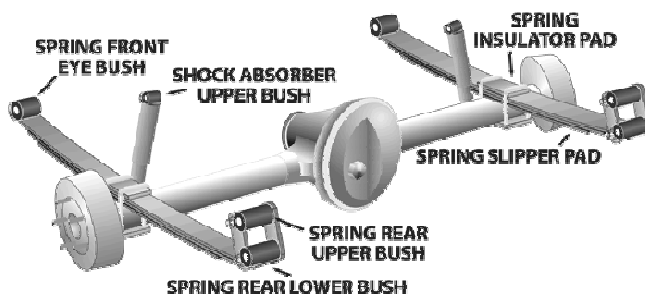
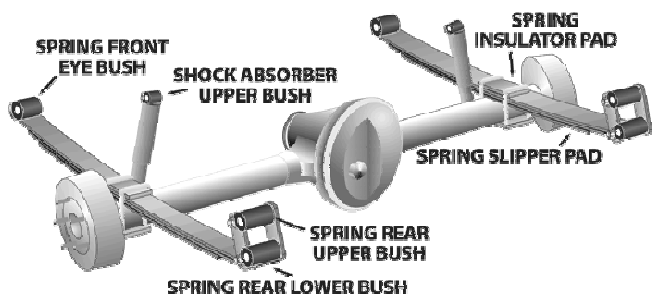

Aplicaci...	Descripción	Referencia	Kits por...	Contenido del Kit	
TRAS.	Complete Rear Kit Bushings fit factory leaf springs only, Not aftermarket leaf springs, Contents 1xSPF1781K, 1xSPF1782K,...	MPK-087K	1		
TRAS.	Spring Front Eye Bushing Bushings fit factory leaf springs only, Not aftermarket leaf springs	MPU-1782K	1	Inner Tubes, Bushings	
TRAS.	Spring Rear Eye Bushing Bushings fit factory leaf springs only, Not aftermarket leaf springs	MPU-1798K	1	Bushings	
TRAS.	Spring Shackle Upper Bushing Bushings fit factory leaf springs only, Not aftermarket leaf springs	MPU-1781K	1	Bushings	
TRAS.	Sway Bar End Link Bushing	MPU-0280K	1	Inner Tubes, Bushings	
TRAS.	Sway Bar Mount to Link Bushing Only suits 38mm original bracket height, see picture above, please supply bar size; Measure bar diameter 20,22,23,24,25,26,27,28,29,30,31,32,34mm...	MPU-1155-__K	1	Bushings	



## TOYOTA Landcruiser 74 Series HZJ74 MWB Mid Wheel Base -

Página 1









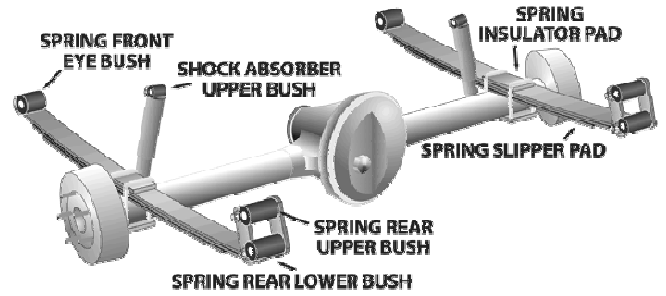
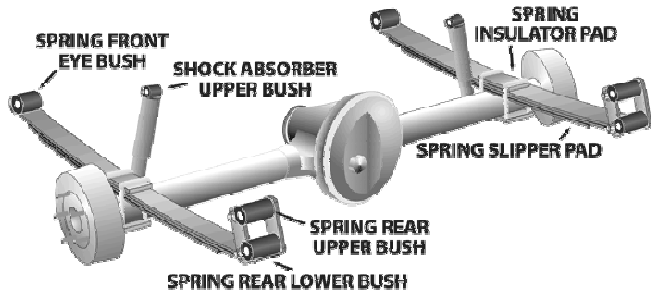

Aplicaci...	Descripción	Referencia	Kits por...	Contenido del Kit	
DEL.	Coil Spring Spacer Bushing	MPU-0252-10K	2	Bushings	
DEL.	Coil Spring Spacer Bushing	MPU-0252-3K	2	Bushings	
DEL.	Coil Spring Spacer Bushing	MPU-0252-6K	2	Bushings	
DEL.	Panhard Rod Bushing Remove original shell	MPU-0445K	1	Inner Tubes, Bushings	
DEL.	Radius Arm To - Diff Mount - Eccentric Kit Offset centre hole to increase caster settings	MPU-1721K	1	Inst Sheet, Outer Shells, Inner Tubes, Bushings	
DEL.	Radius Arm To - Diff Mount - Eccentric Kit Extra offset "High Lift Vehicles" To increase caster settings	MPU-1721XK	1	Inst Sheet, Outer Shells, Inner Tubes, Bushings	
DEL.	Radius Arm To - Diff Mount Bushing	MPU-0396K	1	Inner Tubes, Bushings	



## TOYOTA Landcruiser 74 Series HZJ74 MWB Mid Wheel Base -

Página 2 (Continúa)









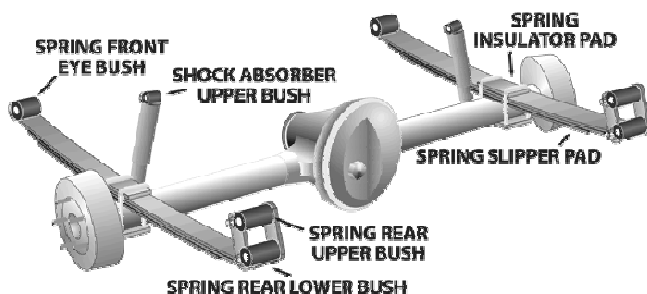
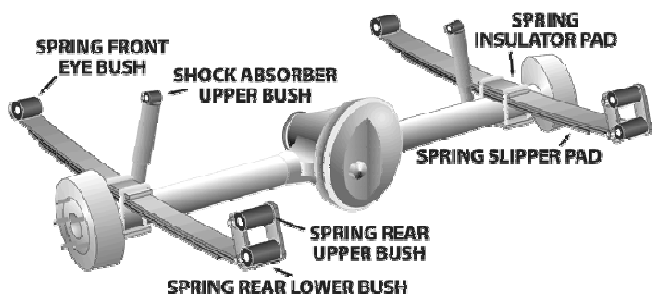

Aplicaci...	Descripción	Referencia	Kits por...	Contenido del Kit	
DEL.	Radius Arm To Chassis Mount Bushing	<b>MPU-0440K</b>	1	Inner Tubes, Bushings	
DEL.	Radius Arms & Panhard Rods Bush Kit Complete front kit, Includes adjustable radius arm bushes	<b>MPK-085ADJK</b>	1		
DEL.	Radius Arms & Panhard Rods Bush Kit Complete front kit, includes standard radius arm bushes	<b>MPK-085K</b>	1		
DEL.	Shock Absorber Upper / Lower Bushing	<b>MPU-0740K</b>	2	Bushings	
DEL.	Sway Bar End Link Bushing	<b>MPU-2147K</b>	1	Inner Tubes, Bushings	
DEL.	Sway Bar Mount to Link Bushing Only suits 38mm original bracket height, see picture above, please supply bar size; Measure bar diameter 20,22,23,24,25,26,27,28,29,30,31,32,34mm.	<b>MPU-1155-__K</b>	1	Bushings	



TOYOTA Landcruiser 74 Series HZJ74 MWB Mid Wheel Base -

Página 3 (Continúa)









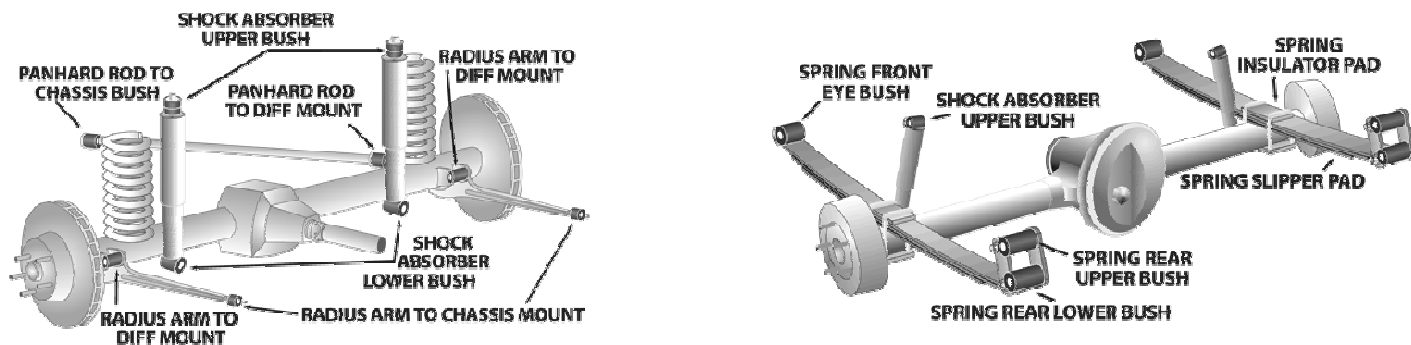

Aplicaci...	Descripción	Referencia	Kits por...	Contenido del Kit	
TRAS.	Complete Rear Kit Bushings fit factory leaf springs only, Not aftermarket leaf springs Contents 1xSPF1781K, 1xSPF1782K, 1x1798K	MPK-087K	1		
TRAS.	Spring Front Eye Bushing Bushings fit factory leaf springs only, Not aftermarket leaf springs	MPU-1782K	1	Inner Tubes, Bushings	
TRAS.	Spring Rear Eye Bushing Bushings fit factory leaf springs only, Not aftermarket leaf springs	MPU-1798K	1	Bushings	
TRAS.	Spring Shackle Upper Bushing Bushings fit factory leaf springs only, Not aftermarket leaf springs	MPU-1781K	1	Bushings	
TRAS.	Sway Bar End Link Bushing	MPU-0280K	1	Inner Tubes, Bushings	
TRAS.	Sway Bar Mount to Link Bushing Only suits 38mm original bracket height, see picture above, please supply bar size; Measure bar diameter 20,22,23,24,25,26,27,28,29,30,31,32,34mm	MPU-1155-__K	1	Bushings	

TOYOTA Landcruiser 79 Series VDJ79R Cab Chassis - 2007 -...

Página 1









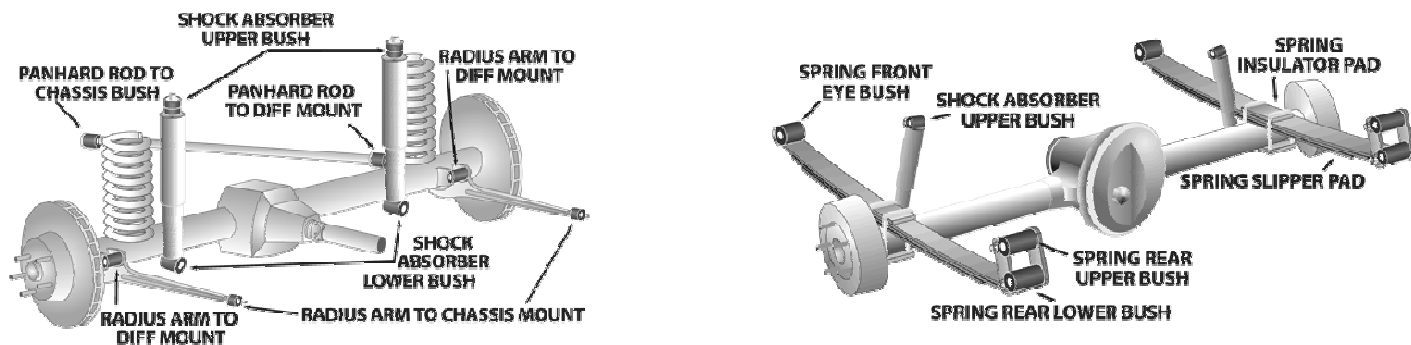

Aplicaci...	Descripción	Referencia	Kits por...	Contenido del Kit	
DEL.	Coil Spring Spacer Bushing	MPU-0252-10K	2	Bushings	
DEL.	Coil Spring Spacer Bushing	MPU-0252-3K	2	Bushings	
DEL.	Coil Spring Spacer Bushing	MPU-0252-6K	2	Bushings	
DEL.	Panhard Rod Bushing Remove original shell.	MPU-0445K	1	Inner Tubes, Bushings	
DEL.	Radius Arm To - Diff Mount - Eccentric Kit Offset center hole to increase caster settings.	MPU-1721K	1	Inst Sheet, Outer Shells, Inner Tubes, Bushings	
DEL.	Radius Arm To - Diff Mount - Eccentric Kit Extra offset "High Lift Vehicles" to increase caster settings.	MPU-1721XK	1	Inst Sheet, Outer Shells, Inner Tubes, Bushings	
DEL.	Radius Arm To - Diff Mount Bushing	MPU-0396K	1	Inner Tubes, Bushings	

**TOYOTA Landcruiser 79 Series VDJ79R Cab Chassis - 2007 -...**

Página 2 (Continúa)







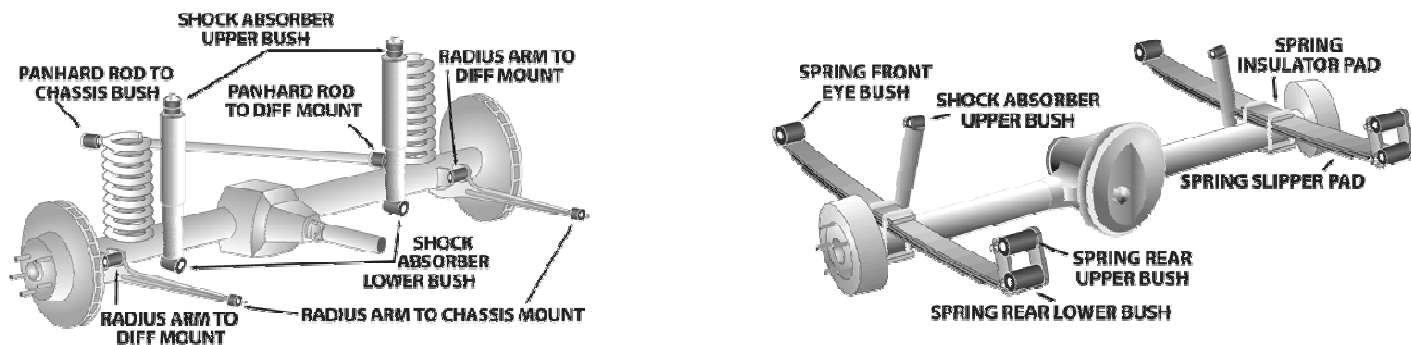

Aplicaci...	Descripción	Referencia	Kits por...	Contenido del Kit	
DEL.	Radius Arm To Chassis Mount Bushing	<b>MPU-0440K</b>	1	Inner Tubes, Bushings	
DEL.	Radius Arms & Panhard Rods Bush Kit Complete front kit, includes standard radius arm bushes.	<b>MPK-085K</b>	1		
DEL.	Radius Arms & Panhard Rods Bush Kit Complete front kit; Includes adjustable radius arm bushes.	<b>MPK-085ADJK</b>	1		
DEL.	Shock Absorber Upper / Lower Bushing	<b>MPU-0740K</b>	2	Bushings	
DEL.	Spring Spacer Upper Bushing	<b>MPU-3119-30K</b>	2	Bushings	
DEL.	Sway Bar End Link Bushing	<b>MPU-2147K</b>	1	Inner Tubes, Bushings	
DEL.	Sway Bar Mount to Link Bushing Only suits 38mm original bracket height, please supply bar size; Measure bar diameter...	<b>MPU-1155-__K</b>	1	Bushings	

TOYOTA Landcruiser 79 Series VDJ79R Cab Chassis - 2007 - ...

Página 3 (Continúa)



Aplicaci...	Descripción	Referencia	Kits por...	Contenido del Kit	
DEL.	available.	MPU-1155-__K	1	Bushings	
TRAS.	Leaf Spring Bushing	MPU-3596K	1	Bushings	
TRAS.	Leaf Spring Bushing All	MPU-3595K	1	Bushings	
TRAS.	Leaf Spring Bushing All All suits greaseable shackles	MPK-193K	1	Bushings	
TRAS.	Leaf Spring Bushing All All suits o.e shackles	MPK-194K	1	Bushings	





## TOYOTA Landcruiser 200 Series - 2008 - On

Página 1

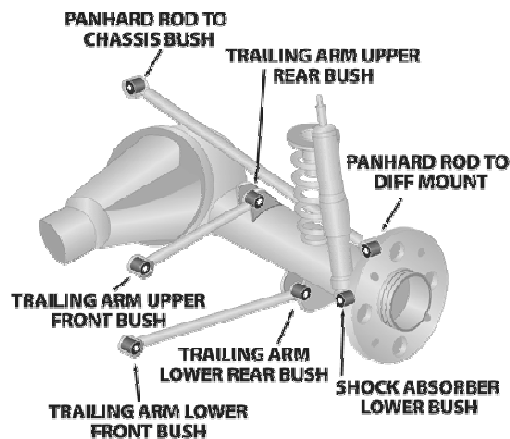
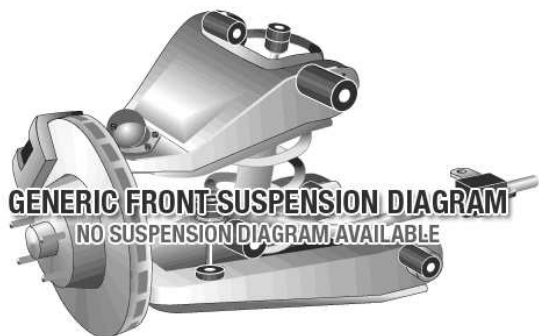

Aplicaci...	Descripción	Referencia	Kits por...	Contenido del Kit	
DEL.	Coil Spring Spacer Bushing	<b>MPU-3281-10K</b>	1	Bushings	
DEL.	Coil Spring Spacer Bushing	<b>MPU-3281-20K</b>	1	Bushings	
DEL.	Control Arm Lower Rear Bushing O.E# 48655-60040	<b>MPU-3278K</b>	1	Bushings, Outer Shells, Inner Tubes	
DEL.	Control Arm Lower-Front Bushing O.E# 48654-60040	<b>MPU-3279K</b>	1	Bushings, Outer Shells, Inner Tubes	
DEL.	Control Arm Upper-Inner Eccentric Kit	<b>MPU-3277XK</b>	1	Washers, Inner Tubes, Bushings	
DEL.	Control Arm Upper-Inner Kit Remove O.E Shell O.E# 48632-60030	<b>MPU-3277K</b>	1	Washers, Inner Tubes, Bushings	
DEL.	Shock Absorber Upper Bushing	<b>MPU-3743K</b>	1	Bushings, Washers	



## TOYOTA Landcruiser 200 Series - 2008 - On

Página 2 (Continúa)

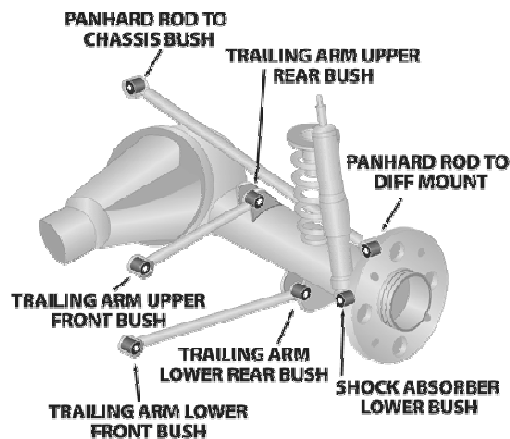
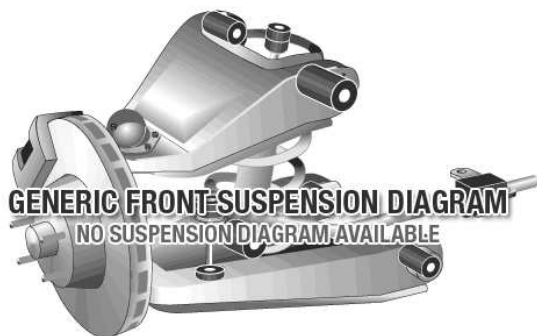



Aplicaci...	Descripción	Referencia	Kits por...	Contenido del Kit	
DEL.	Steering Rack & Pinion Mount Bush.....Power Steering	<b>MPU-3770K</b>	1	Bushings, Washers, Inner Tubes	
DEL.	Sway Bar Mount Bushing Non KDS Vehicle, suits OE bracket# 48824-60170, 32, 35, 37.5, 39 & 40mm available.	<b>MPU-3448-__K</b>	1	Bushings	
TRAS.	Coil Spring Spacer Bushing	<b>MPU-3287-10K</b>	1	Bushings	
TRAS.	Coil Spring Spacer Bushing	<b>MPU-3287-15K</b>	1	Bushings	
TRAS.	Panhard Rod Bushing	<b>MPU-3292K</b>	1	Bushings, Inner Tubes	
TRAS.	Sway Bar Mount Bushing Non KDS Vehicle, Suits OE bracket #48824-26230, 30,33,34mm available.	<b>MPU-3449-__K</b>	1	Bushings	
TRAS.	Trailing Arm - Lower Bushing O.E# 48702-60140	<b>MPU-3286K</b>	1	Bushings, Inner Tubes	

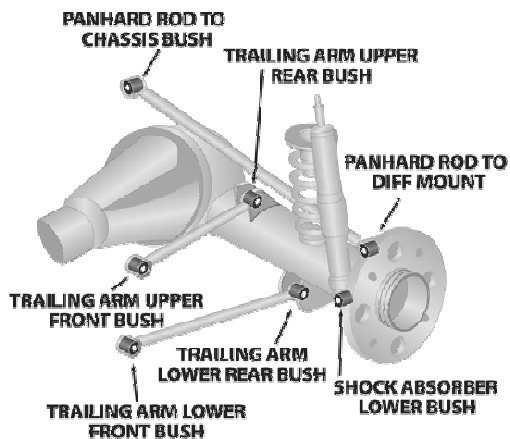
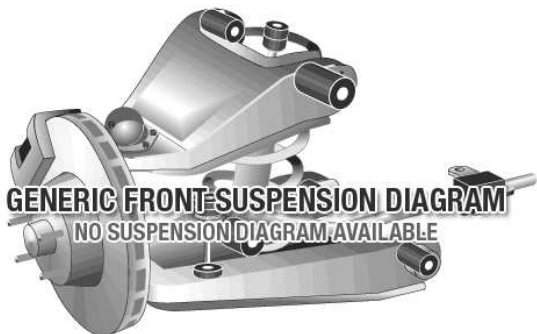

**TOYOTA Landcruiser 200 Series - 2008 - On**

Página 3 (Continúa)









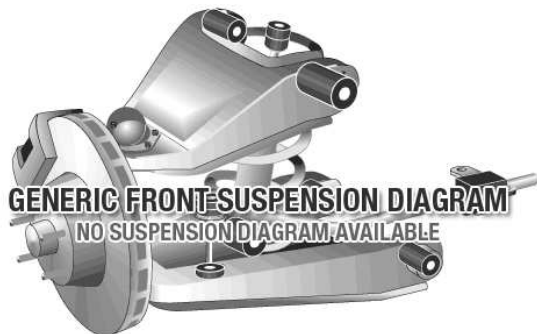

Aplicaci...	Descripción	Referencia	Kits por...	Contenido del Kit	
TRAS.	Trailing Arm Upper Bushing All Remove O.E shell O.E# 48702-60130	<b>MPU-3285K</b>	1	Bushings, Inner Tubes	



## TOYOTA Landcruiser 76 Series - 2007 - Current

Página 1







Aplicaci...	Descripción	Referencia	Kits por...	Contenido del Kit	
DEL.	Coil Spring Spacer Bushing	<b>MPU-0252-10K</b>	2	Bushings	
DEL.	Coil Spring Spacer Bushing	<b>MPU-0252-3K</b>	2	Bushings	
DEL.	Coil Spring Spacer Bushing	<b>MPU-0252-6K</b>	2	Bushings	
DEL.	Radius Arm To - Diff Mount - Eccentric Kit Offset centre hole to increase caster settings.	<b>MPU-1721K</b>	1	Inst Sheet, Outer Shells, Inner Tubes, Bushings	
DEL.	Radius Arm To - Diff Mount - Eccentric Kit Extra offset \"High Lift Vehicles\" to increase caster settings.	<b>MPU-1721XK</b>	1	Inst Sheet, Outer Shells, Inner Tubes, Bushings	
DEL.	Radius Arm To - Diff Mount Bushing	<b>MPU-0396K</b>	1	Inner Tubes, Bushings	
DEL.	Radius Arms & Panhard Rods Bush Kit Complete front kit, includes standard radius arm bushes.	<b>MPK-085K</b>	1		

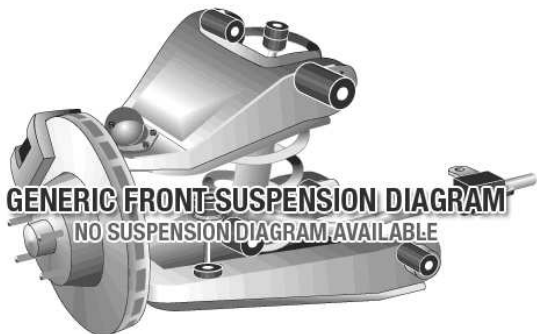

## TOYOTA Landcruiser 76 Series - 2007 - Current

Página 2 (Continúa)



Aplicaci...	Descripción	Referencia	Kits por...	Contenido del Kit	
DEL.	Radius Arms & Panhard Rods Bush Kit Complete front kit, Includes adjustable radius arm bushes.	<b>MPK-085ADJK</b>	1		
DEL.	Shock Absorber Upper / Lower Bushing	<b>MPU-0740K</b>	2	Bushings	
DEL.	Sway Bar Mount to Link Bushing Only suits 38mm original bracket height, please supply bar size; Measure bar diameter 20,22,23,24,25,26,27,28,29,30,31,32,34mm...	<b>MPU-1155-__K</b>	1	Bushings	



## TOYOTA Landcruiser 79 Series (FZJ79R and HZJ79R) - 1999 -...

Página 1

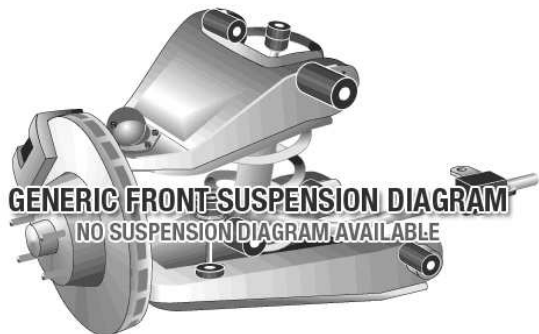

Aplicaci...	Descripción	Referencia	Kits por...	Contenido del Kit	
DEL.	Coil Spring Spacer Bushing	<b>MPU-0252-10K</b>	2	Bushings	
DEL.	Coil Spring Spacer Bushing	<b>MPU-0252-3K</b>	2	Bushings	
DEL.	Coil Spring Spacer Bushing	<b>MPU-0252-6K</b>	2	Bushings	
DEL.	Panhard Rod Bushing Remove original shell.	<b>MPU-0445K</b>	1	Inner Tubes, Bushings	
DEL.	Radius Arm To - Diff Mount - Eccentric Kit Offset center hole to increase caster settings.	<b>MPU-1721K</b>	1	Inst Sheet, Outer Shells, Inner Tubes, Bushings	
DEL.	Radius Arm To - Diff Mount - Eccentric Kit Extra offset \"High Lift Vehicles\" to increase caster settings.	<b>MPU-1721XK</b>	1	Inst Sheet, Outer Shells, Inner Tubes, Bushings	
DEL.	Radius Arm To - Diff Mount Bushing	<b>MPU-0396K</b>	1	Inner Tubes, Bushings	



TOYOTA Landcruiser 79 Series (FZJ79R and HZJ79R) - 1999 -...

Página 2 (Continúa)

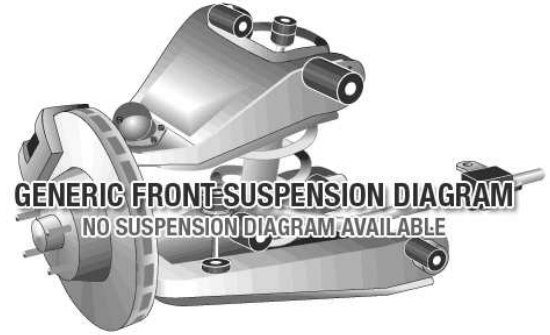





Aplicaci...	Descripción	Referencia	Kits por...	Contenido del Kit	
DEL.	Radius Arm To Chassis Mount Bushing	MPU-0440K	1	Inner Tubes, Bushings	
DEL.	Radius Arms & Panhard Rods Bush Kit Complete front kit; Includes standard radius arm bushes.	MPK-085K	1		
DEL.	Radius Arms & Panhard Rods Bush Kit Complete front kit; Includes adjustable radius arm bushes.	MPK-085ADJK	1		
DEL.	Shock Absorber Upper / Lower Bushing	MPU-0740K	2	Bushings	
DEL.	Spring Spacer Upper Bushing	MPU-3119-30K	2	Bushings	
DEL.	Sway Bar End Link Bushing	MPU-2147K	1	Inner Tubes, Bushings	
DEL.	Sway Bar Mount to Link Bushing Only suits 38mm original bracket height, please supply bar size; Measure bar diameter...	MPU-1155-__K	1	Bushings	

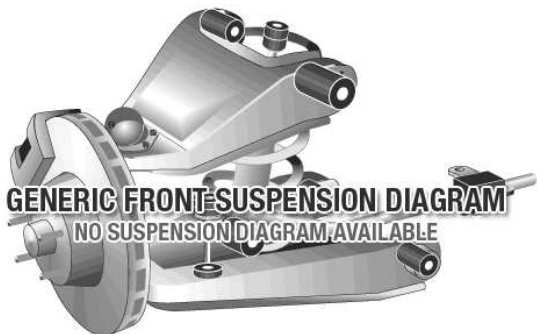

TOYOTA Landcruiser 79 Series (FZJ79R and HZJ79R) - 1999 -...

Página 3 (Continúa)



Aplicaci...	Descripción	Referencia	Kits por...	Contenido del Kit	
DEL.	available.	MPU-1155-__K	1	Bushings	
TRAS.	Leaf Spring Bushing All Suits original swing shackles and pins.	MPK-144K	1	Inner Tubes, Bushings	





TOYOTA Landcruiser 42 Series - 1979 - 10/1984

Página 1

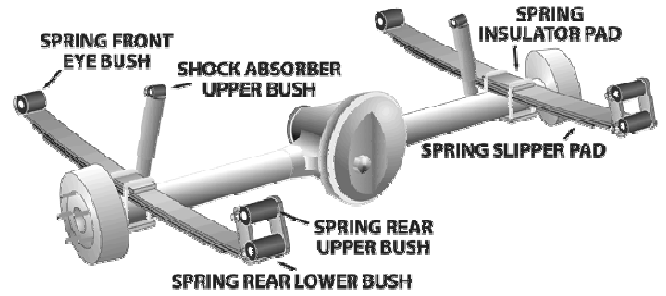
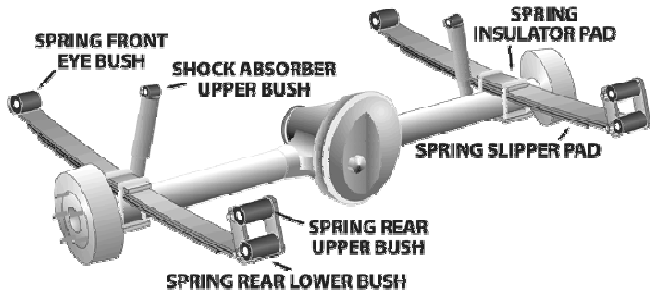







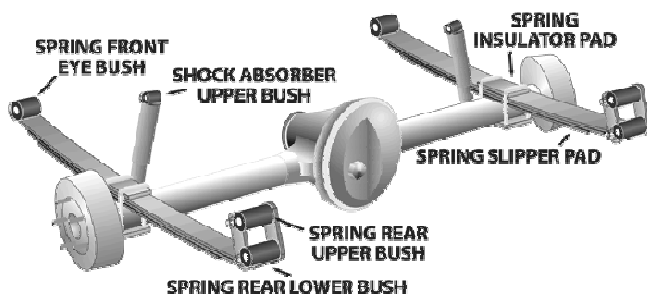
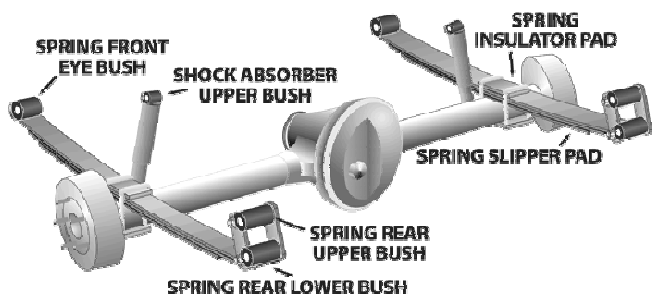

Aplicaci...	Descripción	Referencia	Kits por...	Contenido del Kit	
DEL.	Leaf Spring Bushing All "H" Kits for Severe Conditions or Heavy Duty applications, New design to suit greasable shackles	MPU-2260HK	1	Bushings	
DEL.	Leaf Spring Bushing All OE# 90385-18002, New design to suit greasable shackles	MPU-2260K	1	Bushings	
DEL.	Shock Absorber Upper / Lower Bushing	MPU-2178-16K	2	Bushings	
DEL.	Spring Slipper Pad Bushing	MPU-1419K	1	Bushings	
DEL.	Sway Bar Link Bushing Kit	MPU-2092BK	1	Bushings	
DEL.	Sway Bar Mount To Chassis Bushing Measure bar diameter 14 to 27mm available	MPU-0605-__K	1	Bushings	
F & R	Leaf Spring Bushing All SPF2260K x 2	MPK-027K	1		



## TOYOTA Landcruiser 42 Series - 1979 - 10/1984

Página 2 (Continúa)

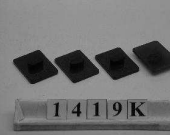







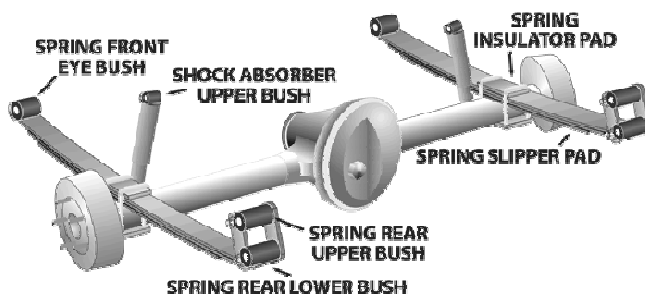
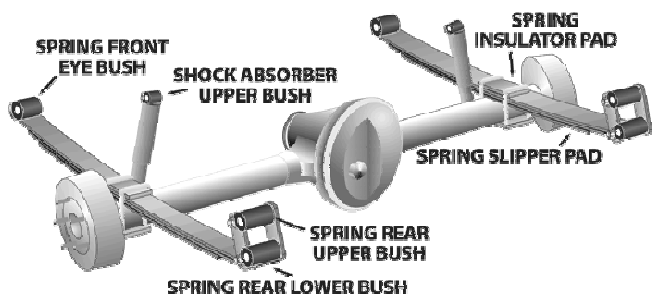

Aplicaci...	Descripción	Referencia	Kits por...	Contenido del Kit	
F & R	Leaf Spring Bushing All "H" Kits for Severe Conditions or Heavy Duty applications	MPK-036HK	1		
TRAS.	Leaf Spring Bushing All New design to suit greasable shackles	MPU-2260HK	1	Bushings	
TRAS.	Leaf Spring Bushing All OE# 90385-18002, New design to suit greasable shackles	MPU-2260K	1	Bushings	
TRAS.	Shock Absorber Upper / Lower Bushing	MPU-0078K	2	Bushings	
TRAS.	Spring Slipper Pad Bushing	MPU-1419K	1	Bushings	
TRAS.	Sway Bar Link Bushing Kit	MPU-0280K	2	Inner Tubes, Bushings	
TRAS.	Sway Bar Mount To Chassis Bushing Measure bar diameter 20,22,24,26mm available	MPU-0105-__K	1	Bushings	



## TOYOTA Landcruiser 55 Series - 1971 - 1980

Página 1

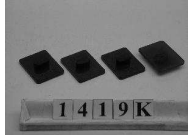





Aplicaci...	Descripción	Referencia	Kits por...	Contenido del Kit	
DEL.	Leaf Spring Bushing All "H" Kits for Severe Conditions or Heavy Duty applications	MPU-2231AHK	1	Bushings	
DEL.	Leaf Spring Bushing All OE# 90385-18025	MPU-2231AK	1	Bushings	
DEL.	Shock Absorber Lower Bushing	MPU-2178-16K	1	Bushings	
DEL.	Shock Absorber Upper Bushing	MPU-2755SK	1	Bushings	
DEL.	Spring Slipper Pad Bushing	MPU-1419K	1	Bushings	
F & R	Leaf Spring Bushing All	MPK-022K	1		
F & R	Leaf Spring Bushing All "H" Kits for Severe Conditions or Heavy Duty applications	MPK-035HK	1		

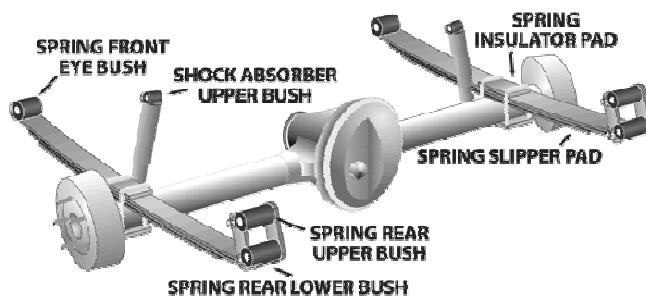
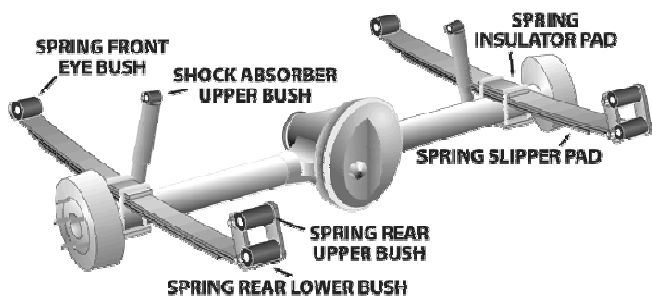

## TOYOTA Landcruiser 55 Series - 1971 - 1980

Página 2 (Continúa)

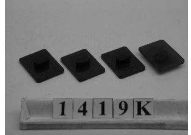

Aplicaci...	Descripción	Referencia	Kits por...	Contenido del Kit	
TRAS.	Leaf Spring Bushing All "H" Kits for Severe Conditions or Heavy Duty applications	MPU-2231AHK	1	Bushings	
TRAS.	Leaf Spring Bushing All OE# 90385-18025	MPU-2231AK	1	Bushings	 2 2 3   1 A K
TRAS.	Shock Absorber Upper / Lower Bushing	MPU-2178-16K	2	Bushings	 SPF2178- K
TRAS.	Spring Slipper Pad Bushing	MPU-1419K	1	Bushings	 1 4   1 9 K



TOYOTA Landcruiser 60 Series - 11/1980 - 5/1990

Página 1

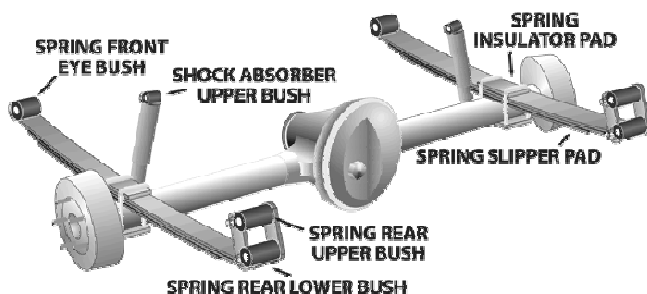
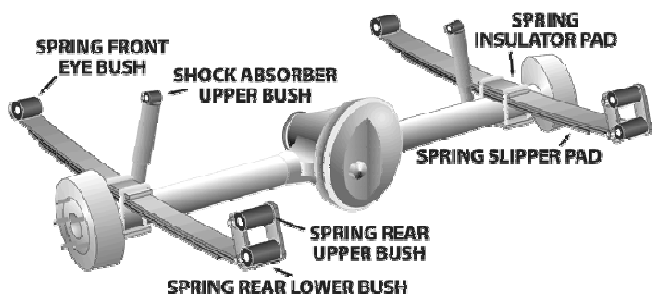







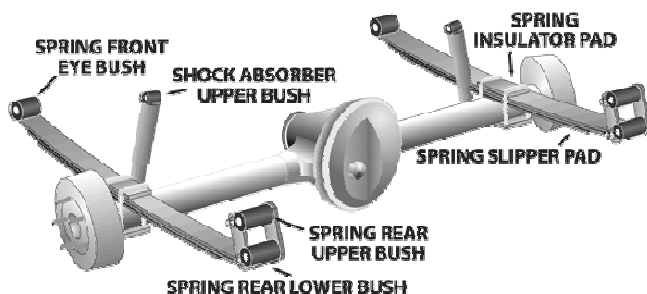
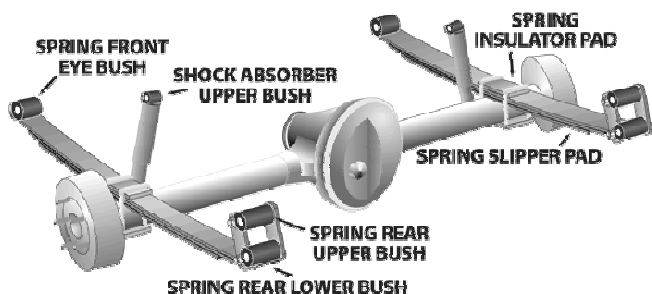

Aplicaci...	Descripción	Referencia	Kits por...	Contenido del Kit	
DEL.	Leaf Spring Bushing All "H" Kits for Severe Conditions or Heavy Duty applications, New design to suit greasable shackles	MPU-2260HK	1	Bushings	
DEL.	Leaf Spring Bushing All OE# 90385-18002, New design to suit greasable shackles	MPU-2260K	1	Bushings	
DEL.	Shock Absorber Lower Bushing	MPU-0078K	1	Bushings	
DEL.	Shock Absorber Upper Bushing	MPU-2755LK	1	Bushings	
DEL.	Spring Slipper Pad Bushing	MPU-1419K	1	Bushings	
DEL.	Sway Bar Link Bushing Kit	MPU-0903K	1	Bushings	
DEL.	Sway Bar Mount To Chassis Bushing Measure bar diameter 14 to 27mm available	MPU-0605-__K	1	Bushings	



TOYOTA Landcruiser 60 Series - 11/1980 - 5/1990

Página 2 (Continúa)



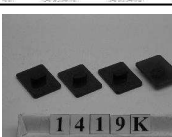



Aplicaci...	Descripción	Referencia	Kits por...	Contenido del Kit	
F & R	Leaf Spring Bushing All SPF2260K x 2	MPK-027K	1		
F & R	Leaf Spring Bushing All "H" Kits for Severe Conditions or Heavy Duty applications	MPK-036HK	1		
TRAS.	Leaf Spring Bushing All "H" Kits for Severe Conditions or Heavy Duty applications, New design to suit greasable shackles	MPU-2260HK	1	Bushings	
TRAS.	Leaf Spring Bushing All OE# 90385-18002, New design to suit greasable shackles	MPU-2260K	1	Bushings	
TRAS.	Shock Absorber Upper / Lower Bushing Up to 10/1985	MPU-2178-16K	2	Bushings	
TRAS.	Shock Absorber Upper / Lower Bushing 11/1995 on	MPU-0078K	2	Bushings	
TRAS.	Spring Slipper Pad Bushing	MPU-1419K	1	Bushings	

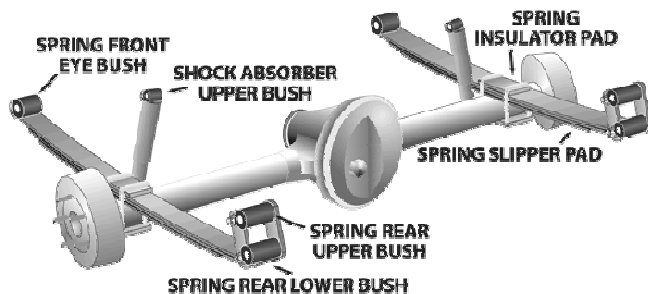
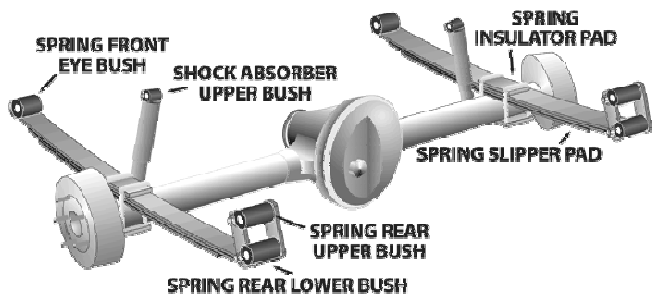

**TOYOTA Landcruiser 60 Series - 11/1980 - 5/1990**

Página 3 (Continúa)



Aplicaci...	Descripción	Referencia	Kits por...	Contenido del Kit	
TRAS.	Sway Bar Link Bushing Kit	<b>MPU-0280K</b>	2	Inner Tubes, Bushings	 SPF0280K
TRAS.	Sway Bar Mount To Axle Bushing Measure bar diameter 14 to 27mm available	<b>MPU-0605-__K</b>	1	Bushings	

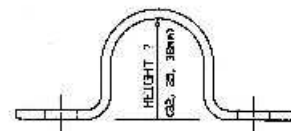

## TOYOTA Landcruiser 78 Series, Troop Carrier Wagon -...

Página 1

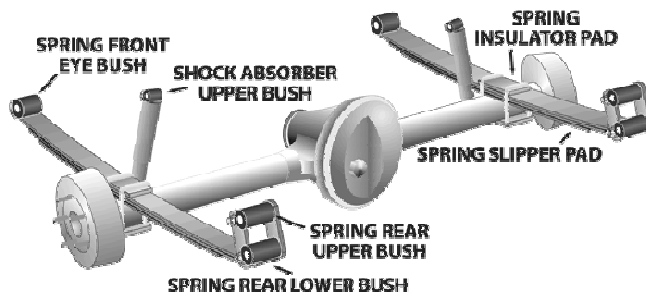
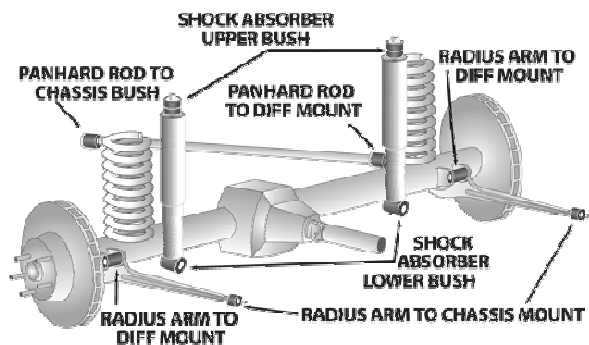

Aplicaci...	Descripción	Referencia	Kits por...	Contenido del Kit	
DEL.	Coil Spring Spacer Bushing	<b>MPU-0252-10K</b>	2	Bushings	
DEL.	Coil Spring Spacer Bushing	<b>MPU-0252-3K</b>	2	Bushings	
DEL.	Coil Spring Spacer Bushing	<b>MPU-0252-6K</b>	2	Bushings	
DEL.	Panhard Rod Bushing Remove original shell	<b>MPU-0445K</b>	1	Inner Tubes, Bushings	
DEL.	Radius Arm To - Diff Mount - Eccentric Kit Offset centre hole to increase caster settings	<b>MPU-1721K</b>	1	Inst Sheet, Outer Shells, Inner Tubes, Bushings	
DEL.	Radius Arm To - Diff Mount - Eccentric Kit Extra offset "High Lift Vehicles" To increase caster settings	<b>MPU-1721XK</b>	1	Inst Sheet, Outer Shells, Inner Tubes, Bushings	
DEL.	Radius Arm To - Diff Mount Bushing	<b>MPU-0396K</b>	1	Inner Tubes, Bushings	



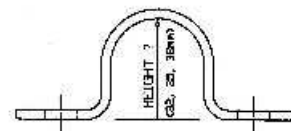





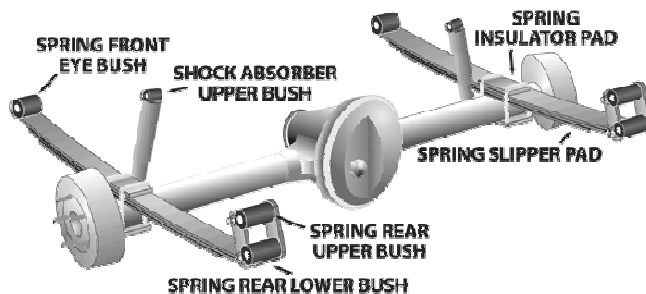
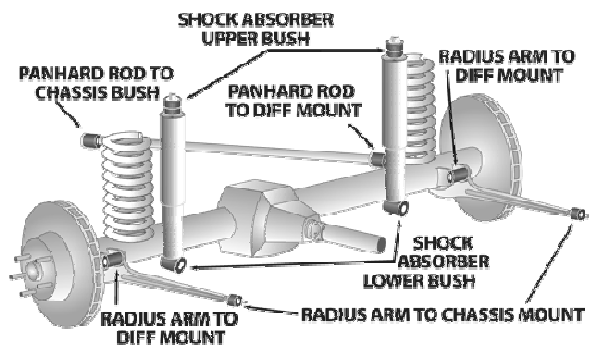

## TOYOTA Landcruiser 78 Series, Troop Carrier Wagon -...

Página 2 (Continúa)





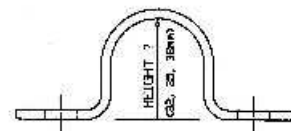



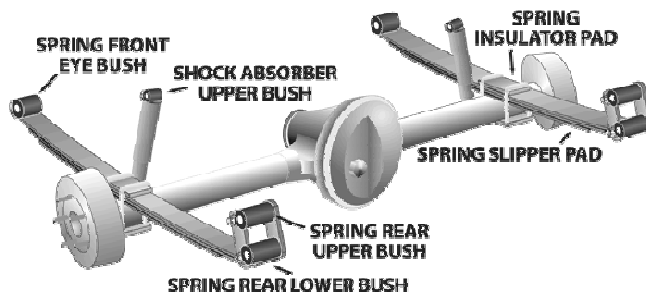
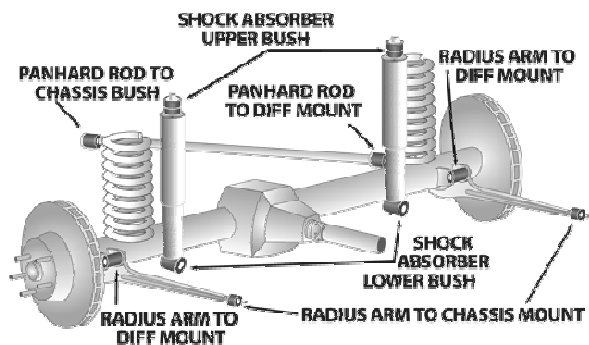

Aplicaci...	Descripción	Referencia	Kits por...	Contenido del Kit	
DEL.	Radius Arm To Chassis Mount Bushing	<b>MPU-0440K</b>	1	Inner Tubes, Bushings	
DEL.	Radius Arms & Panhard Rods Bush Kit Complete front kit, Includes adjustable radius arm bushes.	<b>MPK-085ADJK</b>	1		
DEL.	Radius Arms & Panhard Rods Bush Kit Complete front kit, includes standard radius arm bushes	<b>MPK-085K</b>	1		
DEL.	Shock Absorber Upper / Lower Bushing	<b>MPU-0740K</b>	2	Bushings	
DEL.	Sway Bar End Link Bushing	<b>MPU-2147K</b>	1	Inner Tubes, Bushings	
DEL.	Sway Bar Mount to Link Bushing Only suits 38mm original bracket height, please supply bar size; Measure bar diameter 20,22,23,24,25,26,27,28,29,30,31,32,34mm...	<b>MPU-1155-__K</b>	1	Bushings	



## TOYOTA Landcruiser 78 Series, Troop Carrier Wagon -...

Página 3 (Continúa)



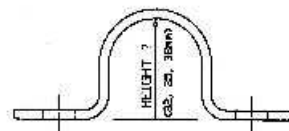

Aplicaci...	Descripción	Referencia	Kits por...	Contenido del Kit	
TRAS.	Complete Rear Kit To suit - 79 Series, Cab-chassis, Contents 1 x SPF1781K & 2 X SPF1782K	<b>MPK-086K</b>	1		
TRAS.	Complete Rear Kit To suit-78 Series, Troop Carrier, Contents 1xSPF1781K,1xSPF1782K, 1x1798K	<b>MPK-087K</b>	1		
TRAS.	Spring Front Eye Bushing Fits both 78 & 79 series	<b>MPU-1782K</b>	1	Inner Tubes, Bushings	
TRAS.	Spring Rear Eye Bushing 79 Series Cab chassis only, Suits original swing shackle only	<b>MPU-1782K</b>	1	Inner Tubes, Bushings	
TRAS.	Spring Rear Eye Bushing 78 Series, Personnel/Troop Carrier wagon only.Suits original swing shackle only	<b>MPU-1798K</b>	1	Bushings	
TRAS.	Spring Shackle Upper Bushing Fits both 78 & 79 series	<b>MPU-1781K</b>	1	Bushings	
TRAS.	Sway Bar End Link Bushing	<b>MPU-0280K</b>	1	Inner Tubes, Bushings	

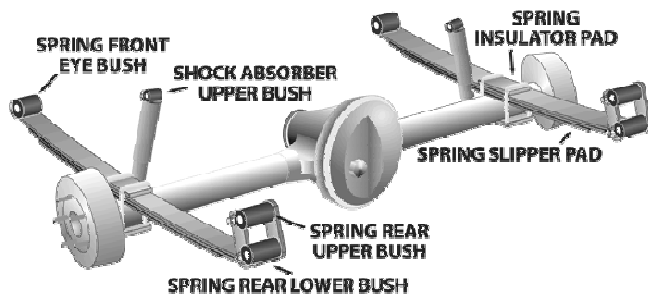
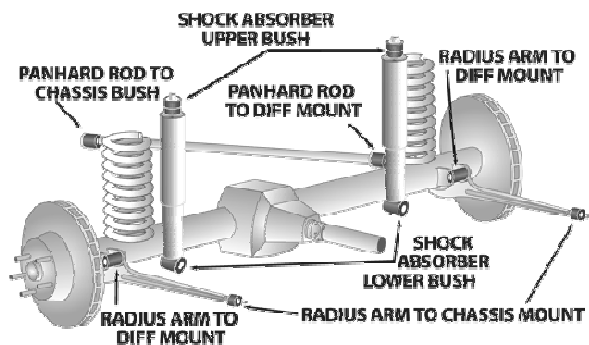

**TOYOTA Landcruiser 78 Series, Troop Carrier Wagon -...**

Página 4 (Continúa)









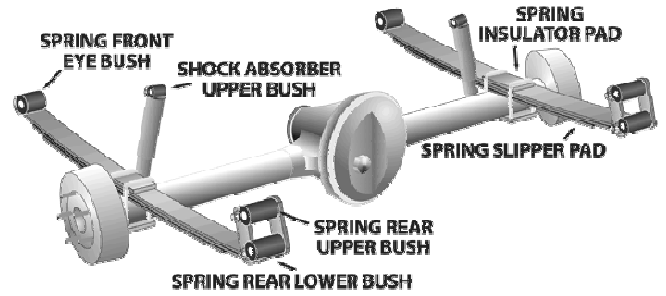
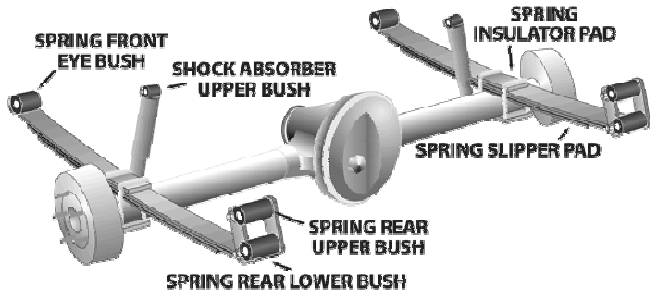

Aplicaci...	Descripción	Referencia	Kits por...	Contenido del Kit	
TRAS.	Sway Bar Mount to Link Bushing Only suits 38mm original bracket height, please supply bar size; Measure bar diameter 20,22,23,24,25,26,27,28,29,30,31,32,34mm...	<b>MPU-1155-__K</b>	1	Bushings	



TOYOTA Landcruiser 40 Series - 1968 - 1980

Página 1





Aplicaci...	Descripción	Referencia	Kits por...	Contenido del Kit	
DEL.	Leaf Spring Bushing All "H" Kits for Severe Conditions or Heavy Duty applications	MPU-2230HK	1	Bushings	
DEL.	Leaf Spring Bushing All OE# 90385-15002.	MPU-2230K	1	Bushings	
DEL.	Shock Absorber Upper / Lower Bushing	MPU-2178-16K	2	Bushings	
F & R	Leaf Spring Bushing All "H" Kits for Severe Conditions or Heavy Duty applications	MPK-020HK	1		
F & R	Leaf Spring Bushing All SPF2230K x 2	MPK-021K	1		
TRAS.	Leaf Spring Bushing All "H" Kits for Severe Conditions or Heavy Duty applications	MPU-2230HK	1	Bushings	
TRAS.	Leaf Spring Bushing All OE# 90385-15002.	MPU-2230K	1	Bushings	

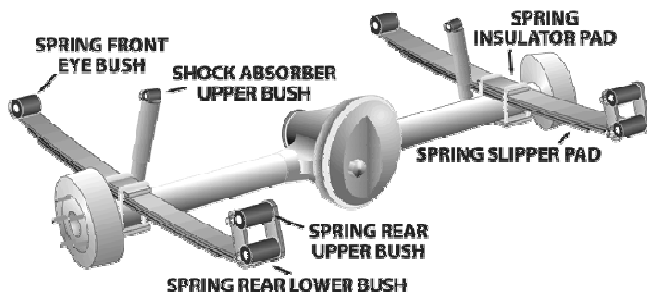
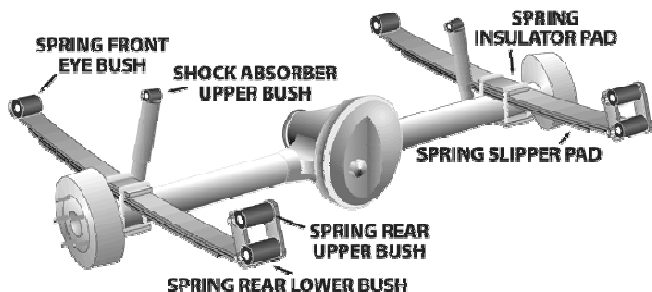

**TOYOTA Landcruiser 40 Series - 1968 - 1980**

Página 2 (Continúa)





Aplicaci...	Descripción	Referencia	Kits por...	Contenido del Kit	
TRAS.	Shock Absorber Upper / Lower Bushing	<b>MPU-2178-16K</b>	2	Bushings	 SPF2178- K

**TOYOTA Dyna RU10 - 1970 - 1977**

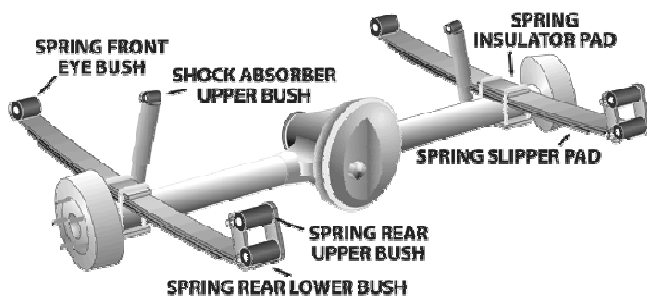
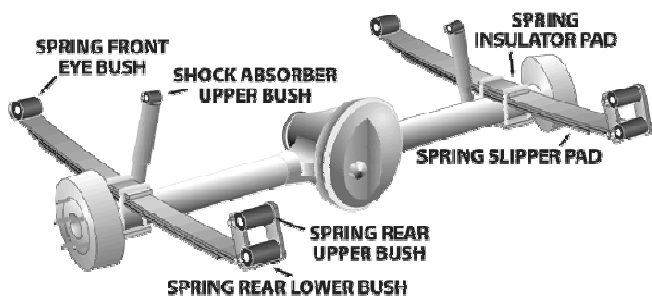
Página 1





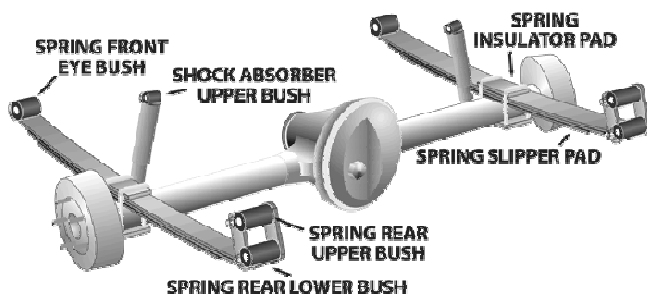
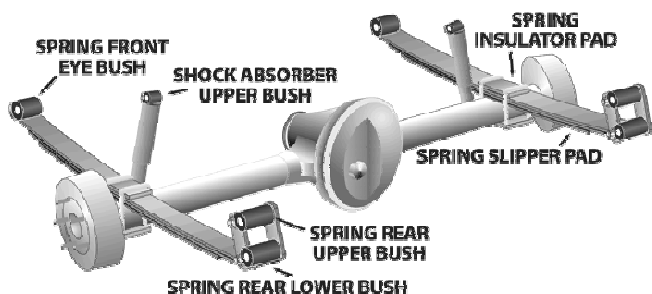

Aplicaci...	Descripción	Referencia	Kits por...	Contenido del Kit	
DEL.	Leaf Spring Bushing All OE# 90385-18025	<b>MPU-2231AHK</b>	1	Bushings	
DEL.	Shock Absorber Upper / Lower Bushing	<b>MPU-2178-16K</b>	2	Bushings	
TRAS.	Shock Absorber Upper / Lower Bushing	<b>MPU-2178-16K</b>	2	Bushings	

**TOYOTA Dyna RU12, RU15 - 1970 - 1977**

Página 1



Aplicaci...	Descripción	Referencia	Kits por...	Contenido del Kit	
DEL.	Leaf Spring Bushing All OE# 90385-18025	<b>MPU-2231AHK</b>	1	Bushings	
DEL.	Shock Absorber Upper / Lower Bushing	<b>MPU-2178-16K</b>	2	Bushings	
TRAS.	Leaf Spring Bushing All	<b>MPU-0215K</b>	3	Bushings	
TRAS.	Shock Absorber Upper / Lower Bushing	<b>MPU-2178-16K</b>	2	Bushings	

**TOYOTA Dyna RU20, RU30 - 8/1977 - 8/1984**

Página 1

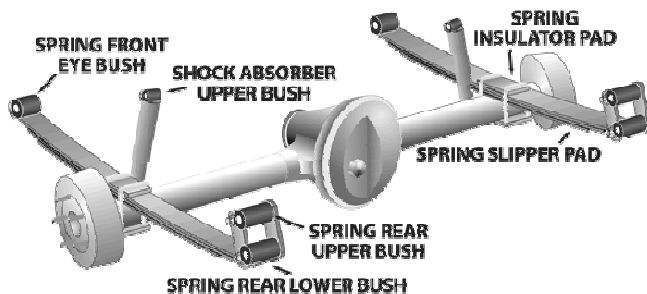
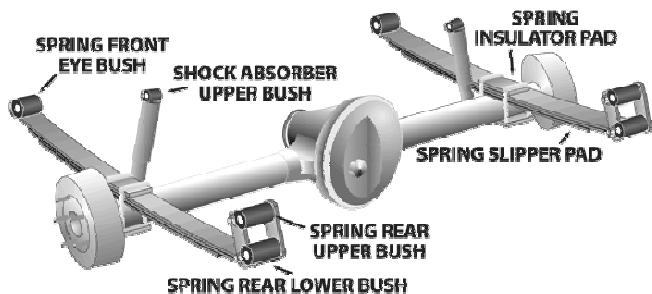

Aplicaci...	Descripción	Referencia	Kits por...	Contenido del Kit	
DEL.	Leaf Spring Bushing All	<b>MPU-0989K</b>	1	Inner Tubes, Bushings	
DEL.	Shock Absorber Lower Bushing	<b>MPU-2178-16K</b>	1	Bushings	
DEL.	Shock Absorber Upper Bushing	<b>MPU-2755LK</b>	1	Bushings	
DEL.	Spring Shackle Upper Bushing RU20 OE# 90385-18025	<b>MPU-2231AHK</b>	1	Bushings	
TRAS.	Leaf Spring Bushing All	<b>MPU-0989K</b>	1	Inner Tubes, Bushings	
TRAS.	Shock Absorber Upper / Lower Bushing	<b>MPU-2178-16K</b>	2	Bushings	





**TOYOTA Dyna Series 100 ( YH81, LH80 ) - 5/1995 - 8/2001**

Página 1

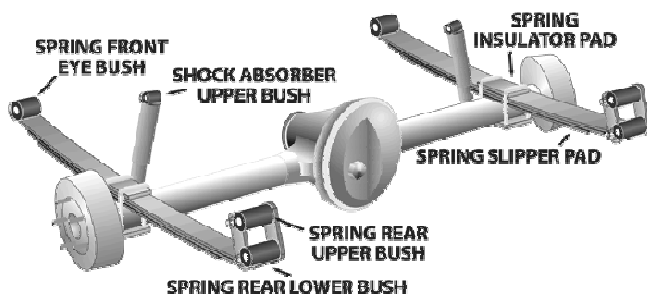
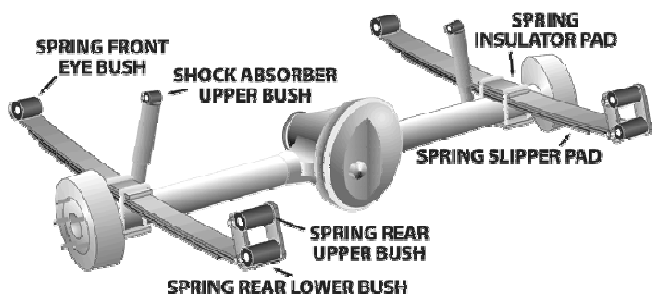





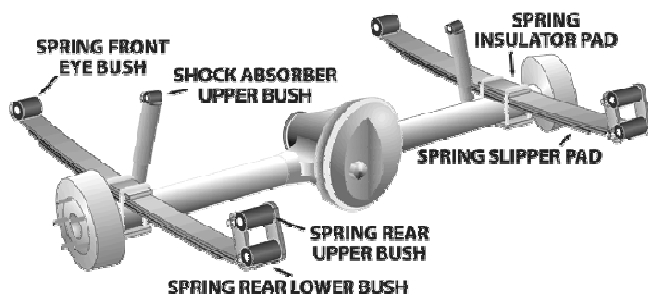
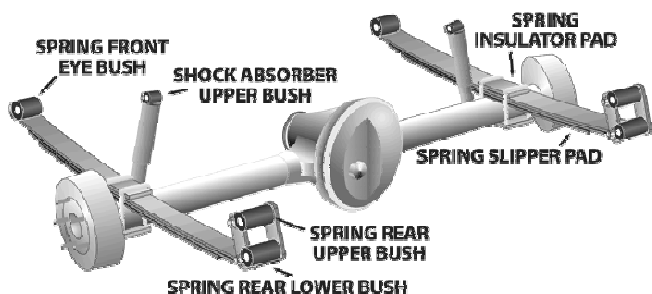

Aplicaci...	Descripción	Referencia	Kits por...	Contenido del Kit	
DEL.	Control Arm Upper-Inner Kit Re-use original shell	<b>MPU-1303K</b>	1	Inner Tubes, Bushings	
DEL.	Idler Arm Bushing 24.1mm OD & 17.95mm ID	<b>MPU-1310K</b>	1	Bushings	
DEL.	Shock Absorber Lower Bushing	<b>MPU-0031K</b>	1	Bushings	
DEL.	Shock Absorber Upper Bushing	<b>MPU-2755LK</b>	1	Bushings	
DEL.	Sway Bar Link Bushing Kit	<b>MPU-2092BK</b>	1	Bushings	
TRAS.	Spring Front Bushing All LY100 , Y Y100, 5/95 on	<b>MPU-2231HK</b>	1	Bushings	
TRAS.	Spring Front Bushing All	<b>MPU-2231HK</b>	1	Bushings	

## TOYOTA Dyna Series 200 ( BU60, 65, 66 ) - 1985 - 1995

Página 1







Aplicaci...	Descripción	Referencia	Kits por...	Contenido del Kit	
DEL.	Leaf Spring Bushing All	MPU-0989K	1	Inner Tubes, Bushings	
DEL.	Leaf Spring Bushing All Must measure shackle pin size 21,22 & 23mm available	MPU-0816-_ _HK	1	Bushings	
DEL.	Shock Absorber Lower Bushing	MPU-2178-16K	1	Bushings	
DEL.	Shock Absorber Upper Bushing	MPU-2755LK	1	Bushings	
TRAS.	Shock Absorber Upper / Lower Bushing	MPU-2178-16K	2	Bushings	
TRAS.	Spring Eye Bushing All	MPU-0989K	1	Inner Tubes, Bushings	

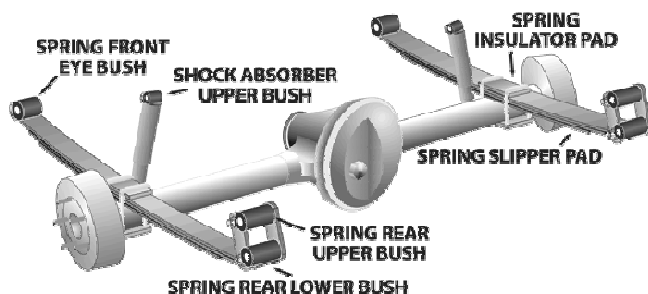
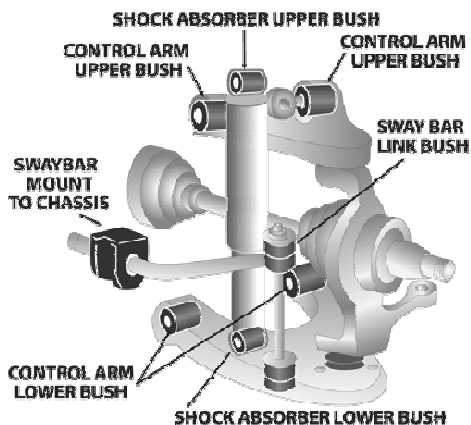

**TOYOTA Hi-Ace SBV - 10/1995 - 2004**

Página 1



Aplicaci...	Descripción	Referencia	Kits por...	Contenido del Kit	
DEL.	Control Arm Upper-Inner Kit Re-use original shell	<b>MPU-1303K</b>	1	Inner Tubes, Bushings	
TRAS.	Torque Rod Bushing Torque rod to chassis	<b>MPU-2347K</b>	1	Bushings, Inner Tubes	



**TOYOTA Hi-Ace 200 Series THR & KDH - 4/2005 - On**

Página 1

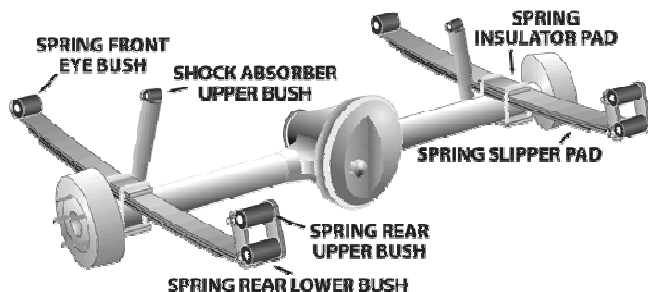
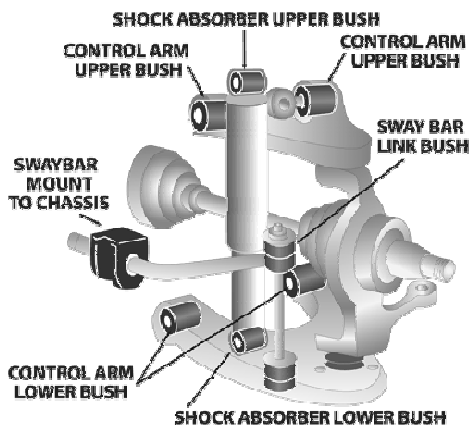

Aplicaci...	Descripción	Referencia	Kits por...	Contenido del Kit	
DEL.	Bump Stop Kit 90 Duro Long Bolt 35.5mm, Bumpstop = 25mm high, thread pitch 3/8 UNF	<b>MPU-3139-90K</b>	1	Nuts, Rods, Washers, Bushings	
DEL.	Bump Stop Kit 90 Duro Short Bolt 22.8mm, Bumpstop = 25mm high, thread pitch 3/8 UNF	<b>MPU-3136-90K</b>	1	Nuts, Rods, Washers, Bushings	
DEL.	Bump Stop Kit 90Duro Short Bolt 22.8mm, Bumpstop = 38mm high, thread pitch 3/8 UNF	<b>MPU-3137-90K</b>	1	Nuts, Rods, Washers, Bushings	
DEL.	Bump Stop Kit 90Duro Short Bolt 22.85mm, Bumpstop = 50mm high, thread pitch 3/8 UNF	<b>MPU-3138-90K</b>	1	Nuts, Rods, Washers, Bushings	
DEL.	Control Arm Lower-Inner Bushing	<b>MPU-1657K</b>	1	Outer Shells, Inner Tubes, Bushings	



**TOYOTA Hi-Ace RH11, RH20, RH32, RH42 - 2/1967 - 11/1982**

Página 1

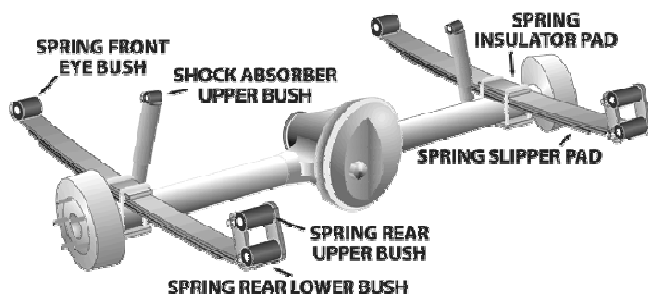
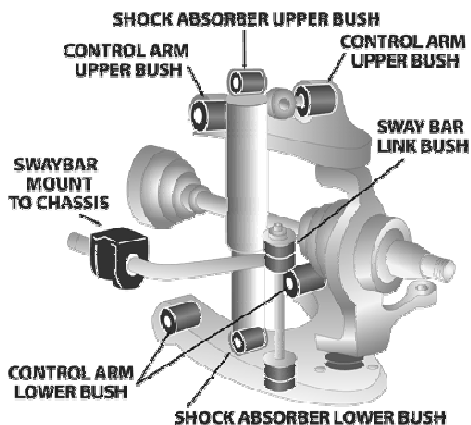





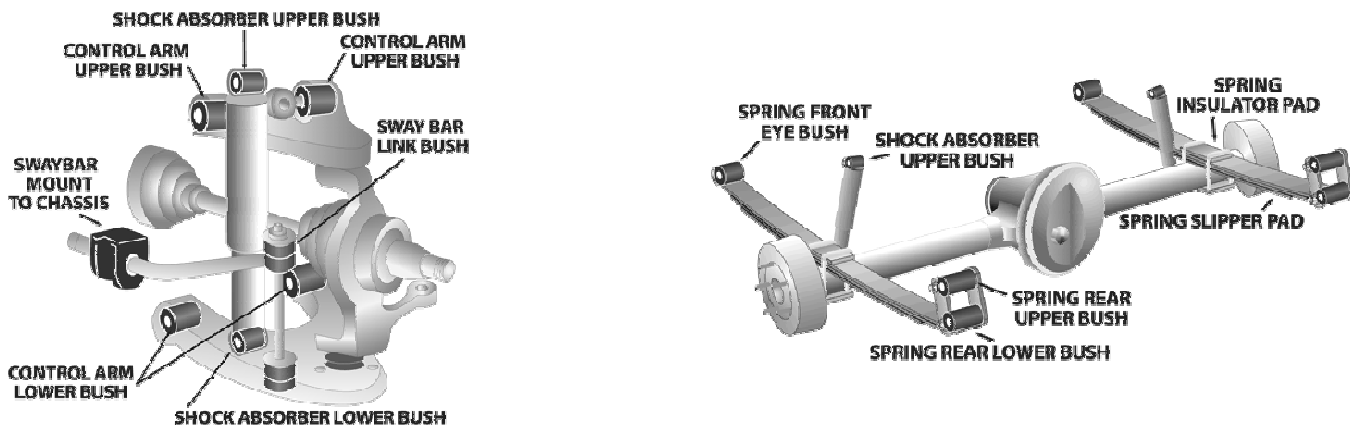

Aplicaci...	Descripción	Referencia	Kits por...	Contenido del Kit	
DEL.	Idler Arm Bushing	<b>MPU-1252K</b>	1	Bushings	
DEL.	Sway Bar Link Bushing Kit	<b>MPU-2092BK</b>	1	Bushings	
TRAS.	Leaf Spring Bushing All LH11, RH11 11/1982 to 7/1985	<b>MPU-2231K</b>	1	Bushings	
TRAS.	Shock Absorber Upper / Lower Bushing	<b>MPU-2178-16K</b>	2	Bushings	
TRAS.	Spring Front Eye Bushing RH20, RH32, RH42	<b>MPU-0972K</b>	1	Inner Tubes, Bushings	
TRAS.	Spring Rear Eye Bushing RH20, RH32, RH42	<b>MPU-0227-4K</b>	1	Bushings	
TRAS.	Spring Shackle Upper Bushing RH20, RH32, RH42	<b>MPU-2231-4K</b>	1	Bushings	

TOYOTA Hilux 2WD GGN15R/TGN16R/KUN16R - 3/2005 -...

Página 1









Aplicaci...	Descripción	Referencia	Kits por...	Contenido del Kit	
DEL.	Spring Seat Bushing	MPU-3002K	1	Bushings	
DEL.	Steering Rack & Pinion Mount Bush.....Power Steering	MPU-3144K	1	Washers, Inner Tubes, Bushings	
TRAS.	Spring Front Eye Bushing GGN15R, 35mm spring inside diameter	MPU-2888K	1	Bushings	
TRAS.	Spring Front Eye Bushing 40mm spring eye inside diameter	MPU-2670K	1	Inner Tubes, Bushings	
TRAS.	Spring Rear Eye Bushing	MPU-2671K	1	Bushings	
TRAS.	Spring Shackle Upper Bushing Bushing located in chassis	MPU-2672K	1	Bushings	

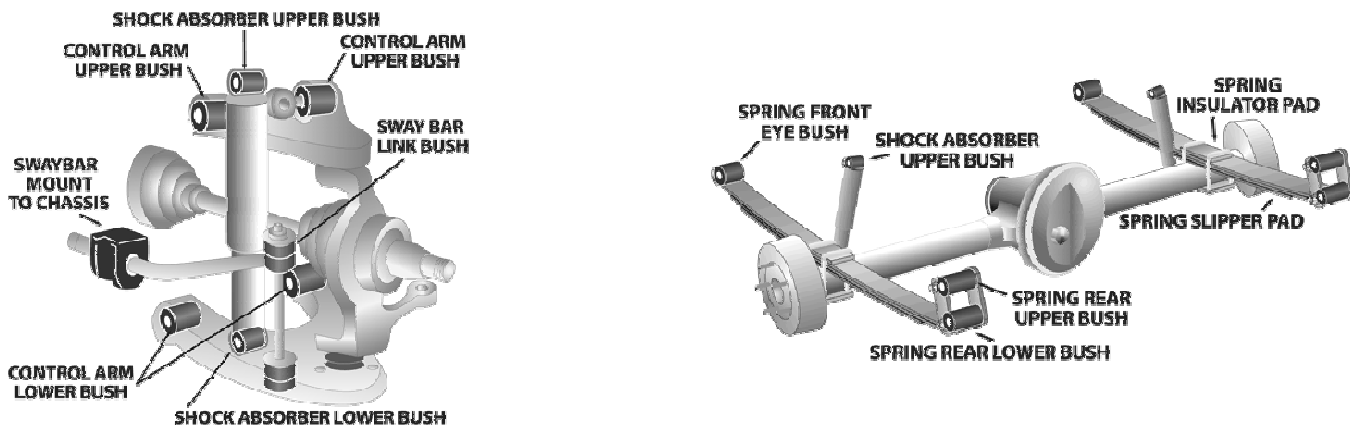

**TOYOTA Hilux 2WD RN10,13,15,16,20,22,23,25 - 3/1968 -...**

Página 1



Aplicaci...	Descripción	Referencia	Kits por...	Contenido del Kit	
DEL.	Idler Arm Bushing 32mm OD bush, 19mm ID bush (straight shackle style bushing)	<b>MPU-1322K</b>	1	Bushings	
DEL.	Shock Absorber Upper Bushing	<b>MPU-0094K</b>	1	Bushings	
DEL.	Sway Bar Link Bushing Kit	<b>MPU-2092BK</b>	1	Bushings	
TRAS.	Leaf Spring Bushing All OE# 90385-18046	<b>MPU-2231K</b>	1	Bushings	
TRAS.	Shock Absorber Upper / Lower Bushing	<b>MPU-2178-16K</b>	2	Bushings	



**TOYOTA Hilux 2WD LN30, LN40 & RN30, RN40 - 8/1978 - 2/1987**

Página 1

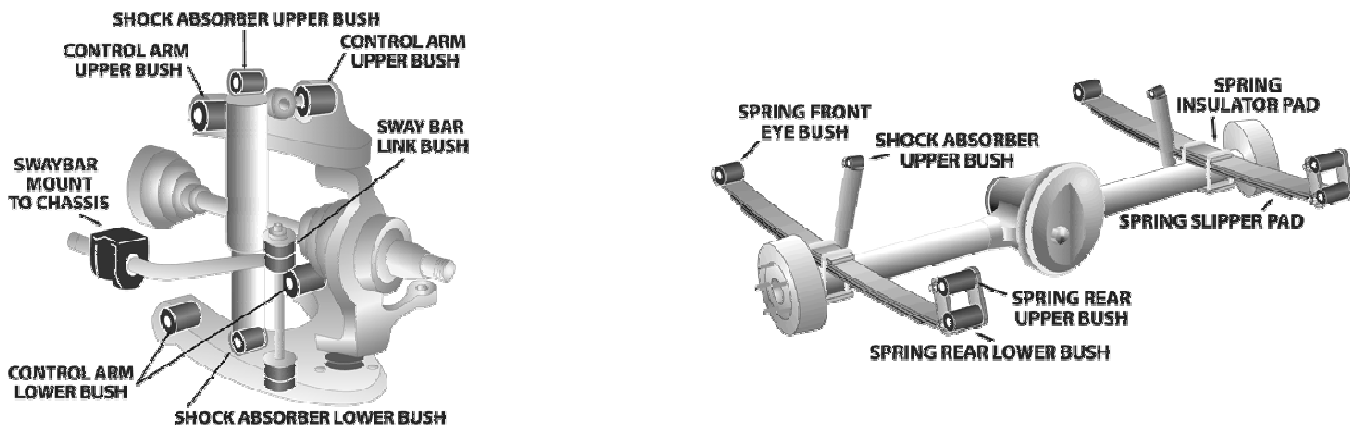

Aplicaci...	Descripción	Referencia	Kits por...	Contenido del Kit	
DEL.	Idler Arm Bushing LN40 555 Brand Idler arm	<b>MPU-1287K</b>	1	Bushings	
DEL.	Shock Absorber Upper Bushing	<b>MPU-0094K</b>	1	Bushings	
DEL.	Strut Bar To Chassis Mount Kit	<b>MPU-0699-22K</b>	1	Bushings	
DEL.	Sway Bar Link Bushing Kit	<b>MPU-2755SK</b>	1	Bushings	
TRAS.	Spring Front Eye Bushing	<b>MPU-0972K</b>	1	Inner Tubes, Bushings	
TRAS.	Spring Rear Bushing All OE# 90385-18046	<b>MPU-2231-8K</b>	1	Bushings	









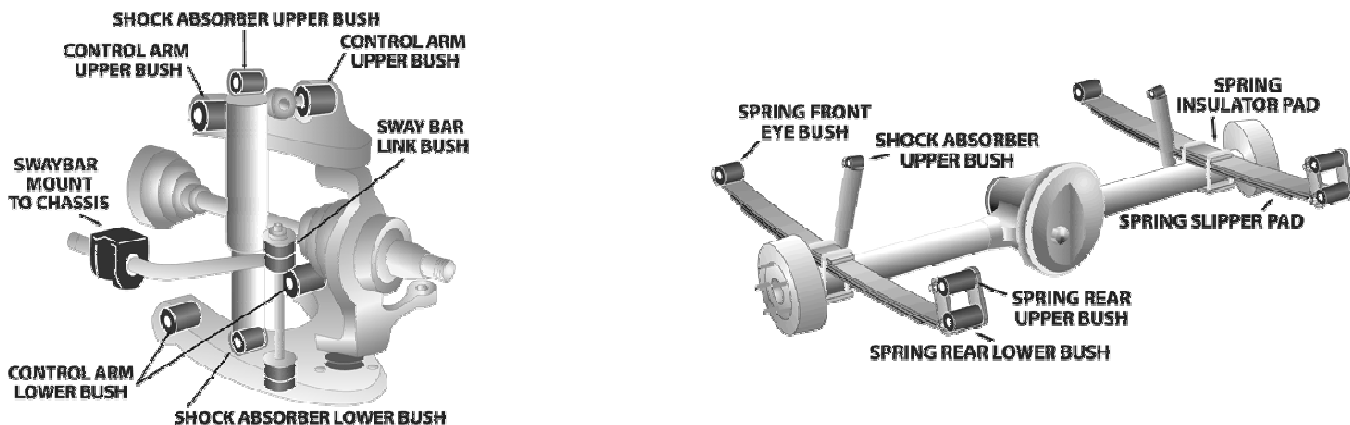

**TOYOTA Hilux 2WD LN50, RN50, YN50 Series - 8/1983 - 8/1988**

Página 1









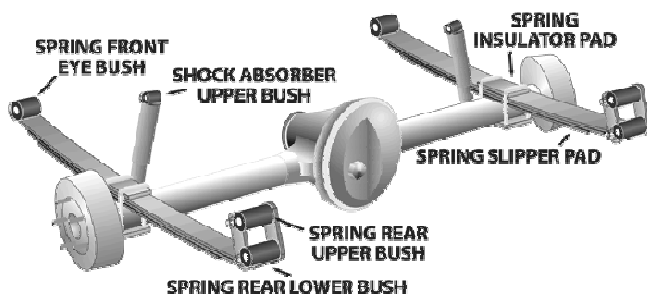
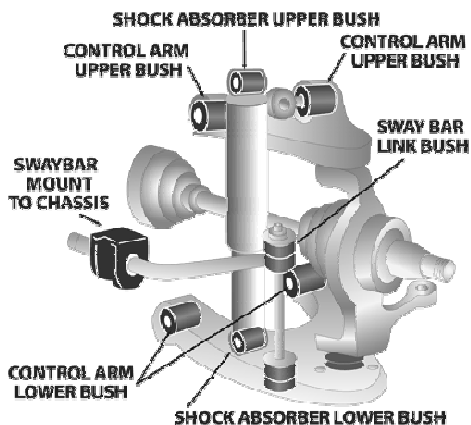

Aplicaci...	Descripción	Referencia	Kits por...	Contenido del Kit	
DEL.	Idler Arm Bushing Tapered 16mm ID, 23mm to 25.25mm taper (SX1145)	<b>MPU-1351K</b>	1	Bushings	
DEL.	Strut Bar To Chassis Mount Kit	<b>MPU-0699-22K</b>	1	Bushings	
DEL.	Sway Bar Link Bushing Kit	<b>MPU-2755SK</b>	1	Bushings	
DEL.	Sway Bar Mount To Chassis Bushing Measure bar diameter 21,22,24mm available	<b>MPU-1285-__K</b>	1	Bushings	
TRAS.	Leaf Spring Bushing All	<b>MPU-2231K</b>	1	Bushings	



## TOYOTA Hilux 4WD Torsion Bar Front & Leaf Rear...

Página 1









Aplicaci...	Descripción	Referencia	Kits por...	Contenido del Kit	
DEL.	Control Arm Lower-Inner Bushing "Re-use original" OE# 48061-35011	<b>MPU-2028K</b>	1	Inner Tubes, Bushings	
DEL.	Control Arm Lower-Inner Bushing Replacement shell & bush Kit OE# 48061-35011	<b>MPU-2337K</b>	1	Outer Shells, Inner Tubes, Bushings	
DEL.	Control Arm Upper-Inner Kit "Re-use original shell"	<b>MPU-1303K</b>	1	Inner Tubes, Bushings	
DEL.	Control Arm Upper-Inner Kit Replacement shell & bush kit	<b>MPU-2338K</b>	1	Bushings, Inner Tubes, Outer Shells	
DEL.	Sway Bar Link Bushing Kit	<b>MPU-2092BK</b>	1	Bushings	
DEL.	Sway Bar Mount To Chassis Bushing Measure bar diameter 17,18,21,23,24 & 25mm available	<b>MPU-1305-__K</b>	1	Bushings	
TRAS.	Leaf Spring Bushing All	<b>MPK-077K</b>	1		

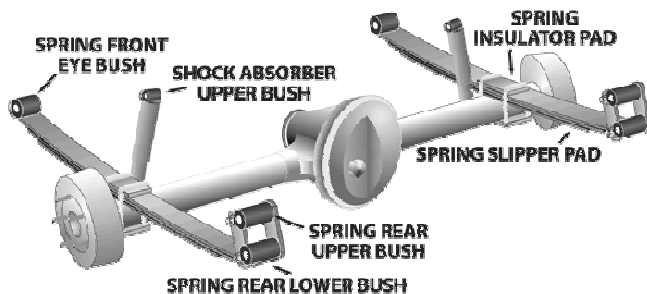
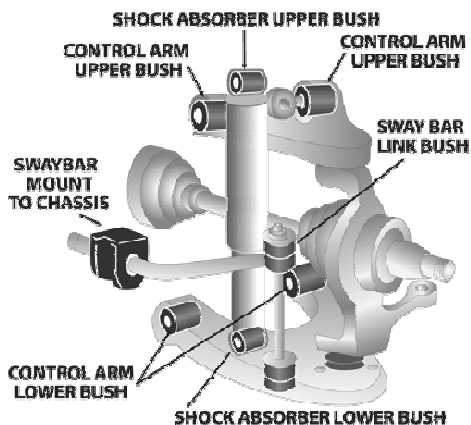

## TOYOTA Hilux 4WD Torsion Bar Front & Leaf Rear...

Página 2 (Continúa)









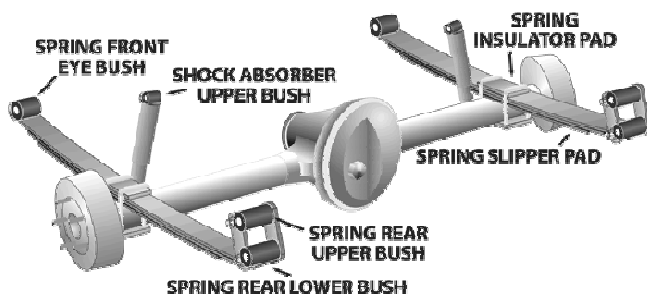
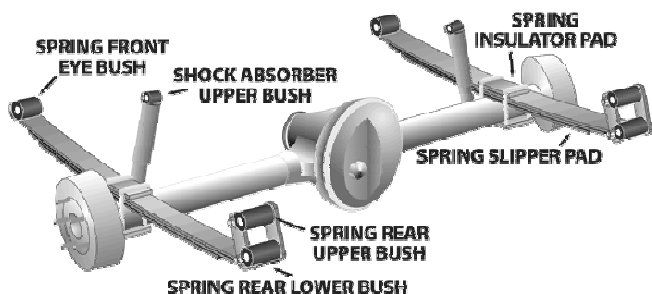

Aplicaci...	Descripción	Referencia	Kits por...	Contenido del Kit	
TRAS.	Spring Front Eye Bushing LN , RN110 ,111 ,107	<b>MPU-0972K</b>	1	Inner Tubes, Bushings	 SPF0972K
TRAS.	Spring Rear Eye Bushing LN , RN110 ,111 ,107 Heavy Duty application	<b>MPU-2231-4HK</b>	1	Bushings	
TRAS.	Spring Rear Eye Bushing LN , RN110 ,111 ,107	<b>MPU-2231-4K</b>	1	Bushings	 SPF2231-4K
TRAS.	Spring Shackle Upper Bushing LN , RN110 ,111 ,107	<b>MPU-1684K</b>	1	Bushings	 SPF1684K



## TOYOTA Four Runner / Surf Leaf Spring, Front & Rear -

Página 1





Aplicaci...	Descripción	Referencia	Kits por...	Contenido del Kit	
DEL.	Leaf Spring Bushing All "H" Kits for Severe Conditions or Heavy Duty applications	MPU-2231-8HK	1	Bushings	
DEL.	Leaf Spring Bushing All OE# 90385-18046	MPU-2231-8K	1	Bushings	
DEL.	Shock Absorber Upper Bushing	MPU-2755LK	1	Bushings	
DEL.	Spring Shackle Upper Bushing "H" Kits for Severe Conditions or Heavy Duty applications	MPU-2240HK	1	Bushings	
DEL.	Spring Shackle Upper Bushing OE# 90385-18007	MPU-2240K	1	Bushings	
DEL.	Torque Rod Bushing	MPU-1251K	1	Inner Tubes, Bushings	
F & R	Leaf Spring Bushing All SPF2231-8K x 1, SPF2240K x 1, SPF2231K x 1	MPK-024K	1		

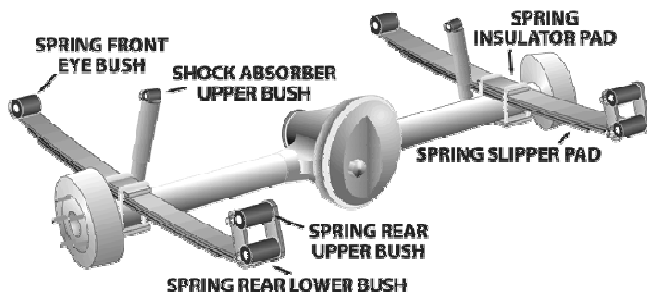
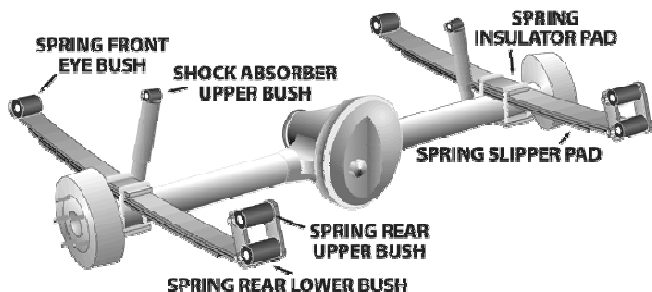

## TOYOTA Four Runner / Surf Leaf Spring, Front & Rear -

Página 2 (Continúa)





Aplicaci...	Descripción	Referencia	Kits por...	Contenido del Kit	
F & R	Leaf Spring Bushing All "H" Kits for Severe Conditions or Heavy Duty applications	<b>MPK-038HK</b>	1		
TRAS.	Leaf Spring Bushing All "H" Kits for Severe Conditions or Heavy Duty applications	<b>MPU-2231HK</b>	1	Bushings	
TRAS.	Leaf Spring Bushing All OE# 90385-18046	<b>MPU-2231K</b>	1	Bushings	
TRAS.	Shock Absorber Upper / Lower Bushing	<b>MPU-0078K</b>	2	Bushings	

## TOYOTA Four Runner / Surf 4 Generation - 2003 - 2008

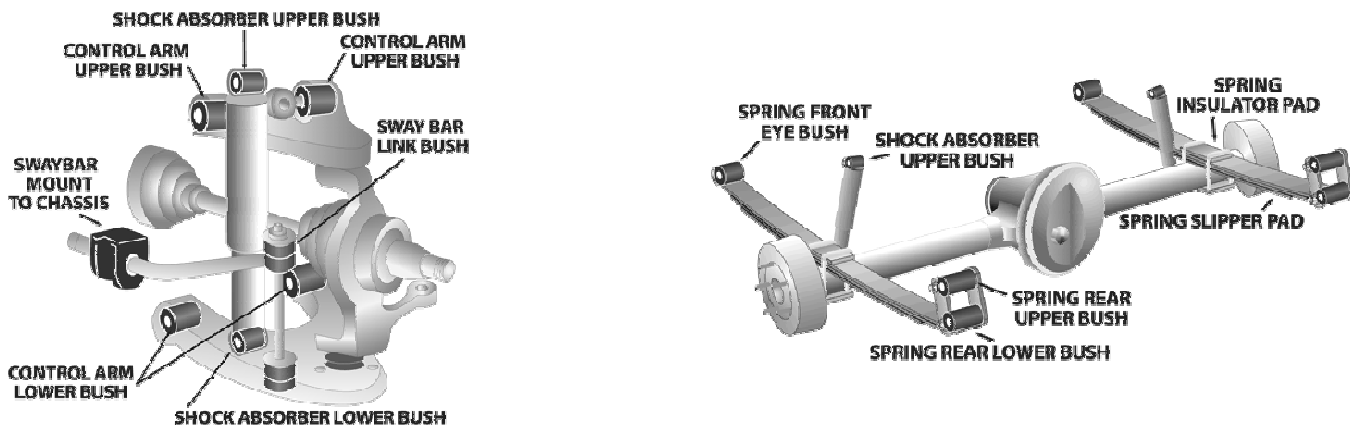
Página 1





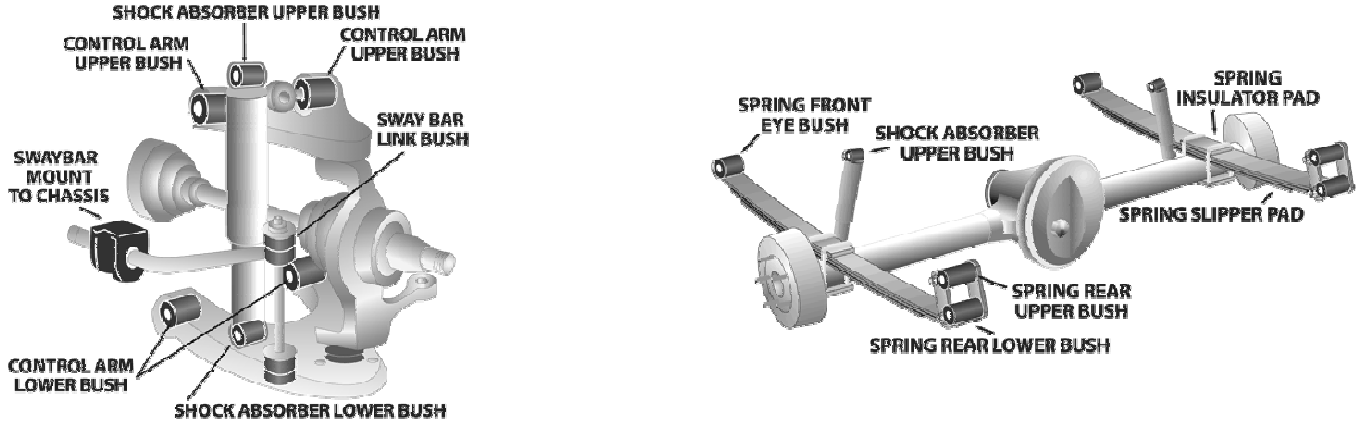

Aplicaci...	Descripción	Referencia	Kits por...	Contenido del Kit	
DEL.	Control Arm Lower-Inner Front & Rear CONTENTS - SPF2834K x 1, SPF2835K x 1	<b>MPK-180K</b>	1	Washers, Outer Shells, Inner Tubes, Bushings	
DEL.	Control Arm Lower-Inner Front Kit Replaces original shell part	<b>MPU-2834K</b>	1	Washers, Outer Shells, Inner Tubes, Bushings	
DEL.	Control Arm Lower-Inner Rear Kit Standard replacement	<b>MPU-2835K</b>	1	Washers, Outer Shells, Inner Tubes, Bushings	
DEL.	Control Arm Upper-Inner Eccentric Kit Offset tube in kit for Camber Decrease on raised vehicles, Remove original shell for fitment	<b>MPU-3230K</b>	1	Inst Sheet, Washers, Inner Tubes, Bushings	
DEL.	Control Arm Upper-Inner Kit Standard replacement, Remove original shell for fitment	<b>MPU-2845K</b>	1	Washers, Inner Tubes, Bushings	
DEL.	Shock Absorber Lower Bushing	<b>MPU-3591K</b>	1	Outer Shells, Inner Tubes, Bushings	
DEL.	Sway Bar Mount Bushing Measure bar diameter, 19, 29mm available	<b>MPU-2506-__K</b>	1	Bushings	

## TOYOTA Four Runner / Surf 4 Generation - 2003 - 2008

Página 2 (Continúa)



Aplicaci...	Descripción	Referencia	Kits por...	Contenido del Kit	
TRAS.	Panhard Rod Bushing Replaces both ends of the bar	<b>MPU-2836K</b>	1	Inner Tubes, Bushings	
TRAS.	Sway Bar Mount Bushing Measure bar diameter, 15,16,17,18,19,20,21,22,23,24,25 & 27mm	<b>MPU-1487-__K</b>	1	Bushings	
TRAS.	Trailing Arm Lower Bushing All	<b>MPU-2461K</b>	2	Inner Tubes, Bushings	
TRAS.	Trailing Arm - Upper Bushing Replaces both ends of the bar	<b>MPU-1760K</b>	2	Inner Tubes, Bushings	



TOYOTA Lite Ace CM, KM - 5/1971 - 8/1985

Página 1

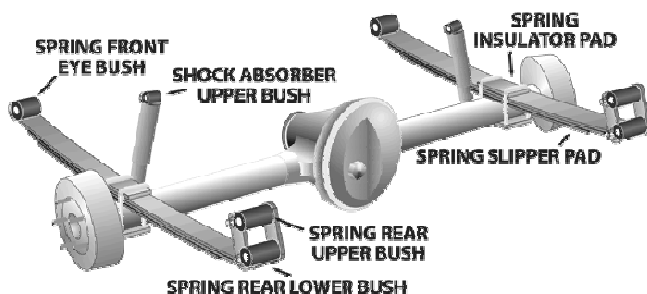
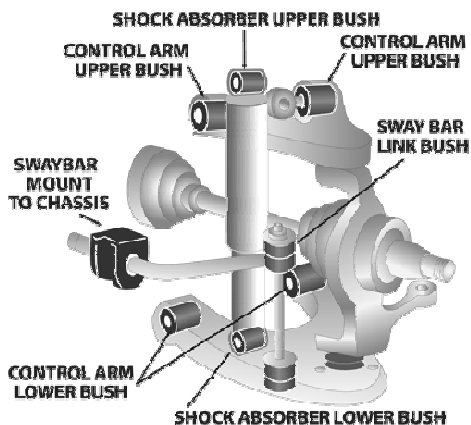

Aplicaci...	Descripción	Referencia	Kits por...	Contenido del Kit	
DEL.	Shock Absorber Upper Bushing	MPU-2755SK	1	Bushings	
TRAS.	Leaf Spring Bushing All Up to 10/1982 OE# 90385-18046	MPU-2231K	1	Bushings	
TRAS.	Shock Absorber Upper / Lower Bushing	MPU-2178-16K	2	Bushings	
TRAS.	Spring Front Eye Bushing	MPU-0972K	1	Inner Tubes, Bushings	
TRAS.	Spring Rear Eye Bushing	MPU-0972K	1	Inner Tubes, Bushings	
TRAS.	Spring Shackle Upper Bushing	MPU-0912K	1	Bushings	







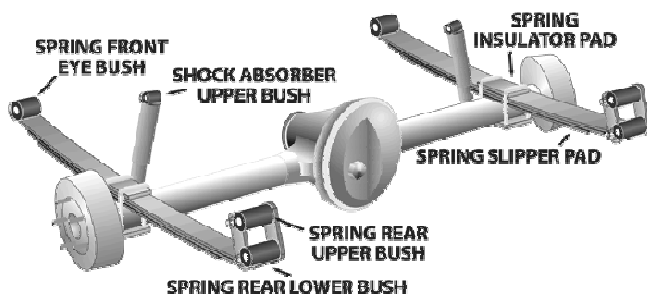
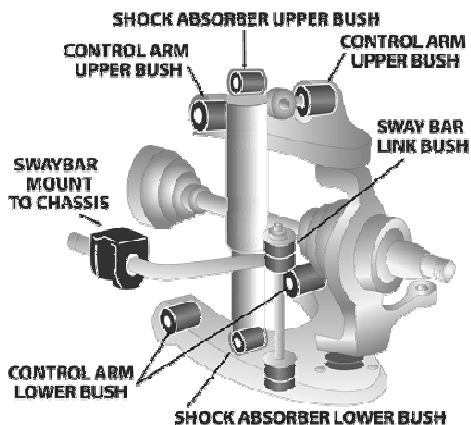

TOYOTA Lite Ace KM30, KM31 - 9/1985 - 8/1988

Página 1





Aplicaci...	Descripción	Referencia	Kits por...	Contenido del Kit	
DEL.	Radius Rod To Chassis Mount Kit	MPU-1733K	1	Inner Tubes, Bushings	
DEL.	Sway Bar Link Bushing Kit	MPU-2092BK	1	Bushings	
TRAS.	Shock Absorber Upper / Lower Bushing	MPU-2178-16K	2	Bushings	

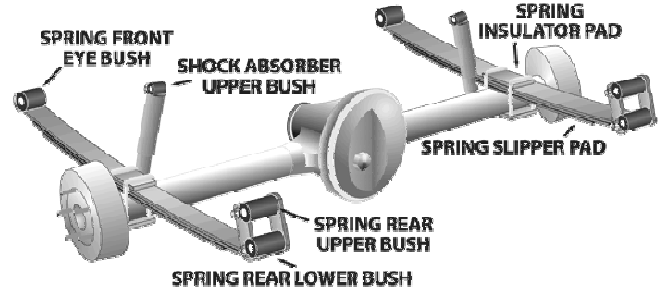
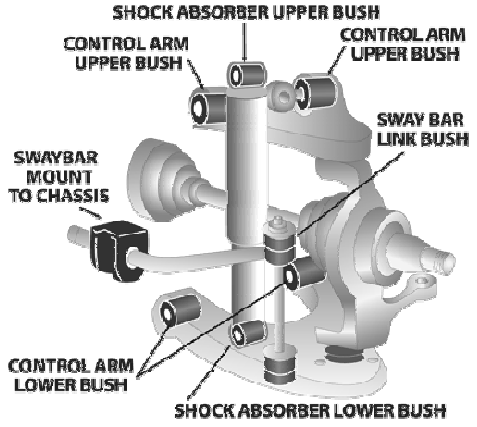

**TOYOTA Lite Ace YM21 RV - 1/1983 - 1985**

Página 1



Aplicaci...	Descripción	Referencia	Kits por...	Contenido del Kit	
DEL.	Radius Rod To Chassis Mount Kit	<b>MPU-1733K</b>	1	Inner Tubes, Bushings	



## TOYOTA Stout Ute - 1969 - 1979

Página 1

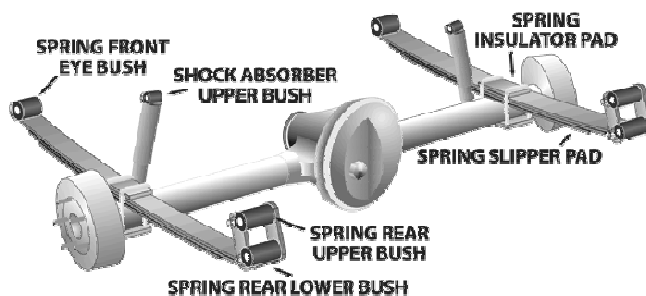
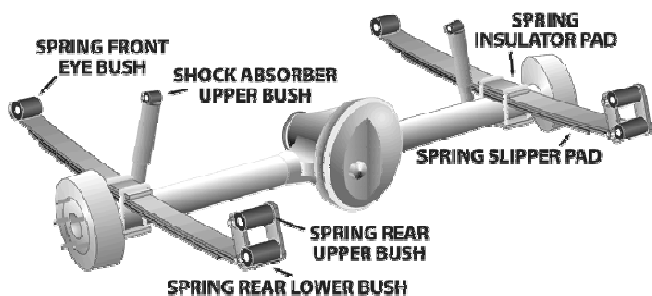

Aplicaci...	Descripción	Referencia	Kits por...	Contenido del Kit	
DEL.	Shock Absorber Lower Bushing	<b>MPU-2178-16K</b>	1	Bushings	
DEL.	Shock Absorber Upper Bushing	<b>MPU-2755LK</b>	1	Bushings	
DEL.	Sway Bar Mount To Chassis Bushing Measure bar diameter 18,19mm available	<b>MPU-0776-__K</b>	1	Bushings	
TRAS.	Leaf Spring Bushing All OE# 90385-18046	<b>MPU-2231K</b>	1	Bushings	
TRAS.	Shock Absorber Upper / Lower Bushing	<b>MPU-2178-16K</b>	2	Bushings	



TOYOTA Tarago YR20, 21, 22, CR21 & YR31 - 11/1982 - 9/1990

Página 1

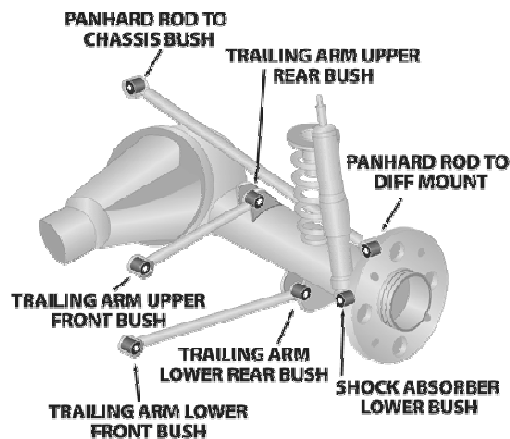
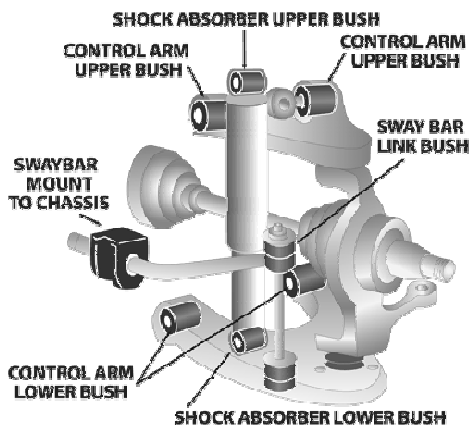







Aplicaci...	Descripción	Referencia	Kits por...	Contenido del Kit	
DEL.	Control Arm Upper-Inner Kit Re-use original outer shell	MPU-1498K	1	Inner Tubes, Bushings	
DEL.	Strut Bar To Chassis Mount Kit	MPU-0699-22K	1	Bushings	
DEL.	Sway Bar Link Bushing Kit	MPU-2092BK	1	Bushings	
DEL.	Sway Bar Mount To Chassis Bushing Measure bar diameter 14 to 27mm available	MPU-0605-__K	1	Bushings	
TRAS.	Panhard Rod To Chassis Mount Kit	MPU-1075K	1	Bushings, Inner Tubes	
TRAS.	Panhard Rod To Diff Mount Bushing	MPU-0963K	1	Bushings, Inner Tubes	
TRAS.	Shock Absorber Lower Bushing	MPU-2178-16K	1	Bushings	

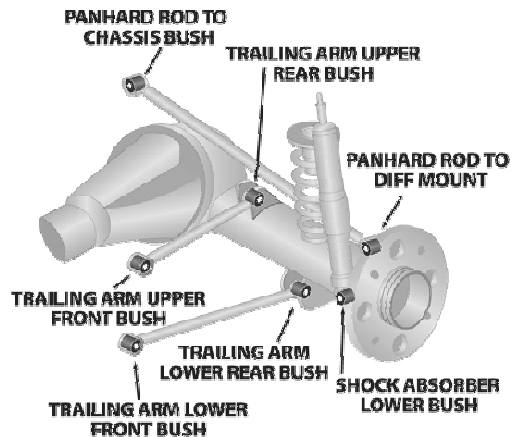
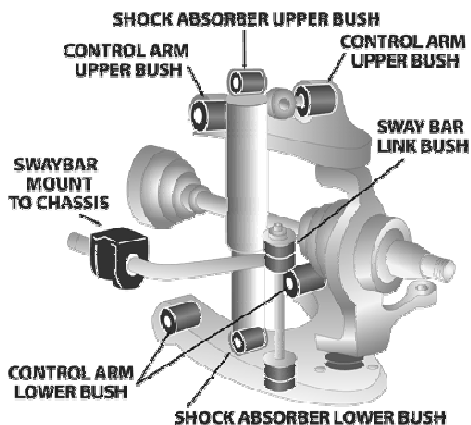

**TOYOTA Tarago YR20, 21, 22, CR21 & YR31 - 11/1982 - 9/1990**

Página 2 (Continúa)



Aplicaci...	Descripción	Referencia	Kits por...	Contenido del Kit	
TRAS.	Shock Absorber Upper Bushing	<b>MPU-2755SK</b>	1	Bushings	
TRAS.	Sway Bar Link Lower Bushing	<b>MPU-0306-4K</b>	1	Bushings	
TRAS.	Sway Bar Link Upper Bushing	<b>MPU-0280K</b>	1	Inner Tubes, Bushings	
TRAS.	Trailing Arm Lower Bushing All	<b>MPU-0827K</b>	1	Inner Tubes, Bushings	
TRAS.	Trailing Arm Upper Bushing All	<b>MPU-0826K</b>	1	Inner Tubes, Bushings	



TOYOTA Tarago / Previa / Estima / Lucida / Emina ACR30...

Página 1

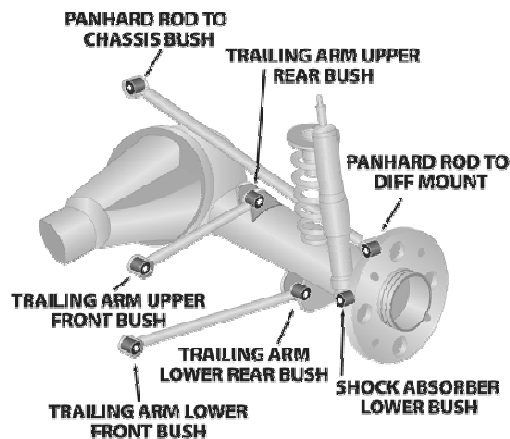
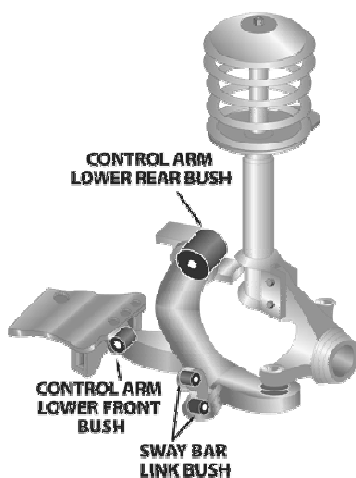

Aplicaci...	Descripción	Referencia	Kits por...	Contenido del Kit	
DEL.	Control Arm Lower-Inner Rear Eccentric 1 x Standard bushing 1 x Offset bushing	<b>MPU-2903K</b>	1	Outer Shells, Inner Tubes, Bushings	
DEL.	Control Arm Lower-Inner Rear Eccentric 2 x Offset bushing kit, Recomendado for vehicles with pull left issues	<b>MPU-2904K</b>	1	Outer Shells, Inner Tubes, Bushings	
DEL.	Control Arm Lower-Inner Rear Kit Standard replacement kit	<b>MPU-2902K</b>	1	Outer Shells, Inner Tubes, Bushings	
DEL.	Steering Rack & Pinion Mount Bush.....Power Steering	<b>MPU-3431K</b>	1	Washers, Inner Tubes, Bushings	



**TOYOTA Tarago / Previa / Estima / Lucida / Emina ACR50...**

Página 1

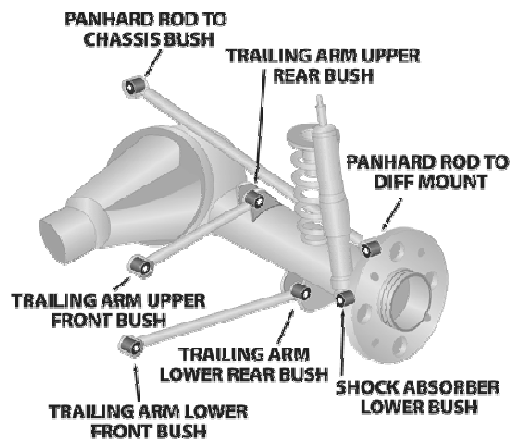
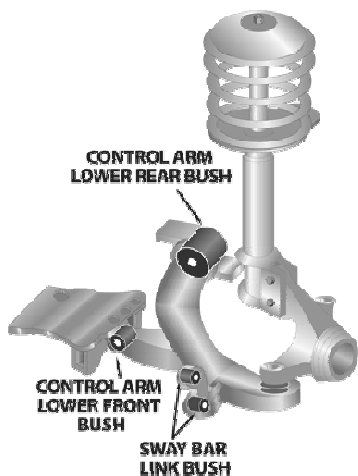







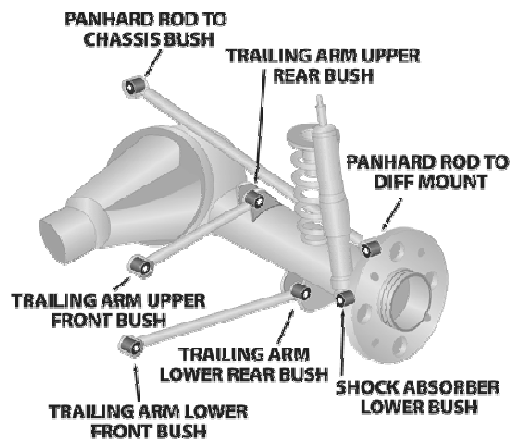
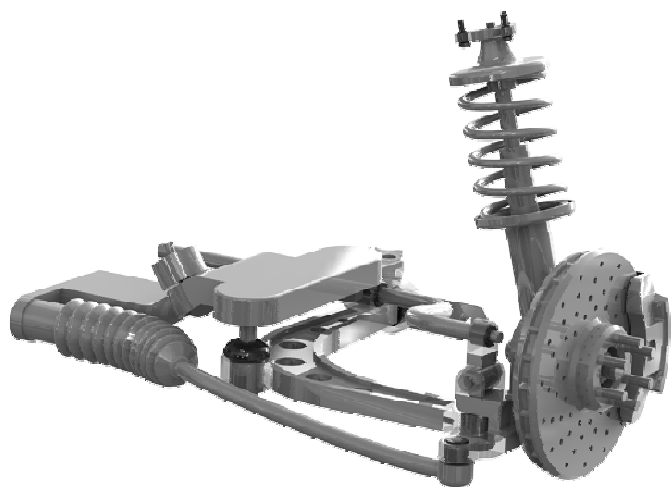

Aplicaci...	Descripción	Referencia	Kits por...	Contenido del Kit	
DEL.	Control Arm Lower-Inner Front Kit O.E# 48654-42040	<b>MPU-3589K</b>	1	Inner Tubes, Bushings	
DEL.	Control Arm Lower-Inner Rear Eccentric DOUBLE OFFSET KIT	<b>MPU-3867K</b>	1	Outer Shells, Inner Tubes, Bushings	
DEL.	Control Arm Lower-Inner Rear Eccentric SINGLE OFFSET KIT	<b>MPU-3866K</b>	1	Outer Shells, Inner Tubes, Bushings	
DEL.	Control Arm Lower-Inner Rear Kit O.E# 48655-28030	<b>MPU-3588K</b>	1	Outer Shells, Inner Tubes, Bushings	



TOYOTA Tercel 4x4 AL25 - 8/1983 - 4/1988

Página 1



Aplicaci...	Descripción	Referencia	Kits por...	Contenido del Kit	
DEL.	Control Arm Lower-Inner Bushing	MPU-1062K	1	Bushings, Inner Tubes	
DEL.	Sway Bar Mount To Chassis Bushing Measure bar diameter 21mm available	MPU-0979-_K	1	Bushings	
DEL.	Sway Bar To Lower Control Arm Kit	MPU-1064K	1	Bushings, Inner Tubes	
TRAS.	Panhard Rod To Chassis Mount Kit	MPU-0427K	1	Bushings, Inner Tubes	
TRAS.	Panhard Rod To Diff Mount Bushing	MPU-0963K	1	Bushings, Inner Tubes	
TRAS.	Shock Absorber Lower Bushing	MPU-2178-16K	1	Bushings	
TRAS.	Shock Absorber Upper Bushing	MPU-2755LK	1	Bushings	









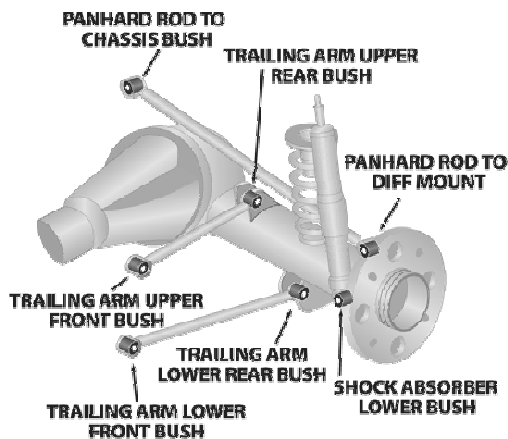
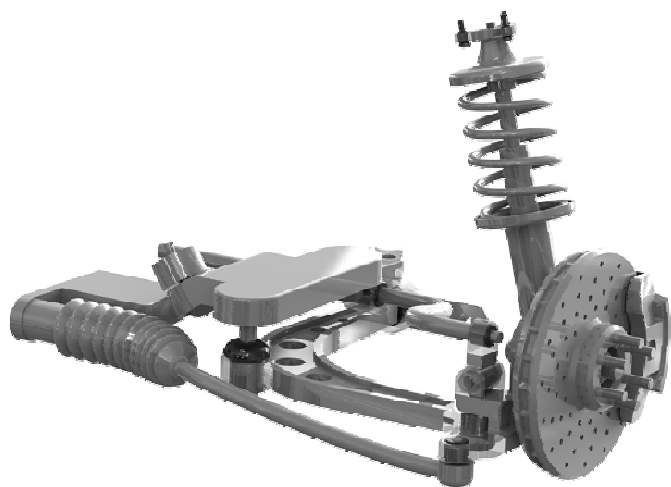

TOYOTA Tercel 4x4 AL25 - 8/1983 - 4/1988

Página 2 (Continúa)









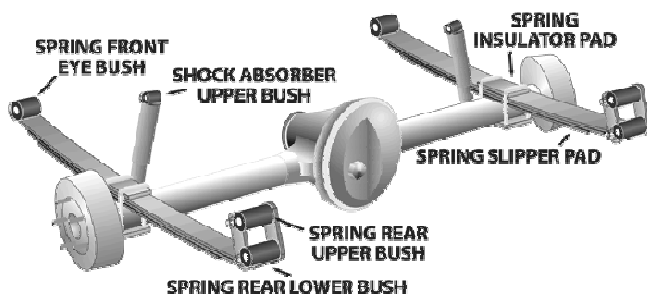
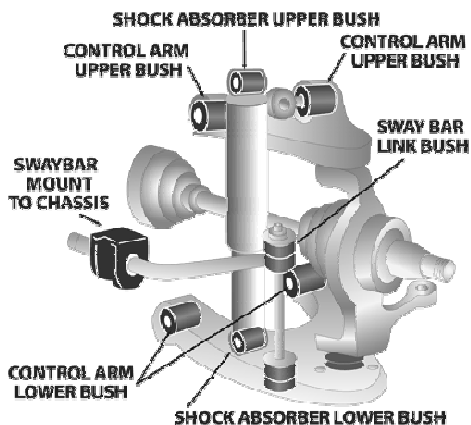

Aplicaci...	Descripción	Referencia	Kits por...	Contenido del Kit	
TRAS.	Sway Bar Link Lower Bushing	<b>MPU-0280K</b>	1	Inner Tubes, Bushings	
TRAS.	Sway Bar Link Upper Bushing	<b>MPU-0306-4K</b>	1	Bushings	
TRAS.	Sway Bar Mount To Axle Bushing Measure bar diameter 13,14,17,18,19,20,21,22,23mm available	<b>MPU-0873-__K</b>	1	Bushings	
TRAS.	Trailing Arm Lower Bushing All	<b>MPU-0980K</b>	1	Inner Tubes, Bushings	
TRAS.	Trailing Arm Upper Bushing All	<b>MPU-0980K</b>	1	Inner Tubes, Bushings	



## TOYOTA Townace Van YR39 - 4/1992 - 12/1996

Página 1





Aplicaci...	Descripción	Referencia	Kits por...	Contenido del Kit	
DEL.	Strut Bar To Chassis Mount Kit	MPU-0699-22K	1	Bushings	
DEL.	Sway Bar Link Bushing Kit	MPU-0280K	2	Inner Tubes, Bushings	
DEL.	Sway Bar Link Bushing Kit	MPU-0903K	1	Bushings	
DEL.	Sway Bar Mount To Chassis Bushing please supply bar size	MPU-1450-__K	1	Bushings	
TRAS.	Shock Absorber Upper / Lower Bushing	MPU-2178-16K	2	Bushings	
TRAS.	Spring Front Eye Bushing	MPU-0972K	1	Inner Tubes, Bushings	
TRAS.	Spring Rear Lower Bushing	MPU-0972K	1	Inner Tubes, Bushings	

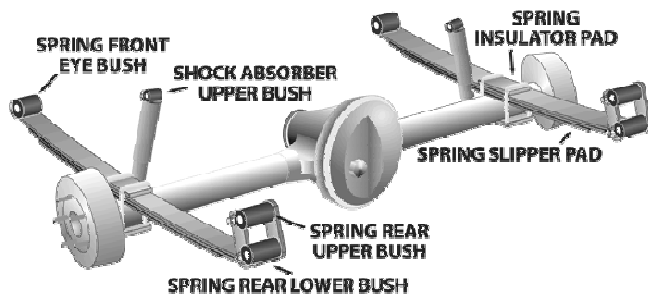
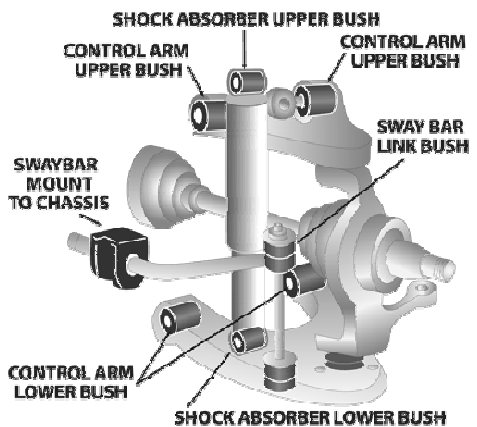

**TOYOTA Townace Van YR39 - 4/1992 - 12/1996**

Página 2 (Continúa)









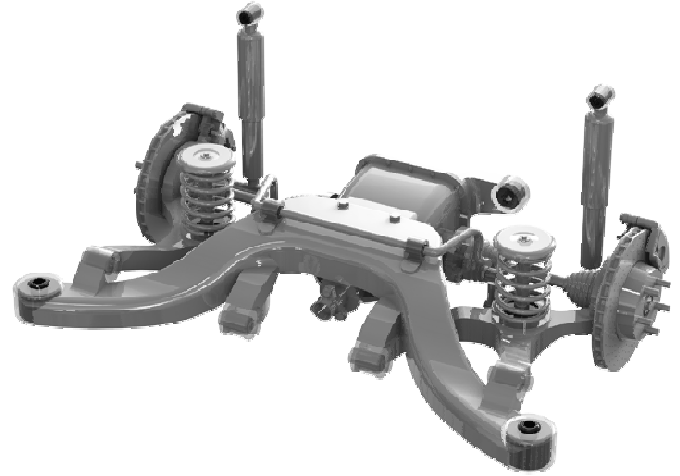
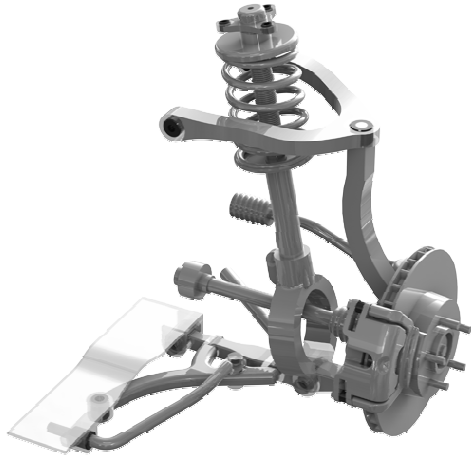

Aplicaci...	Descripción	Referencia	Kits por...	Contenido del Kit	
TRAS.	Spring Shackle Upper Bushing	MPU-0912K	1	Bushings	



## TOYOTA Supra MA60, MA61, SA61 - 12/1981 - 1985

Página 1









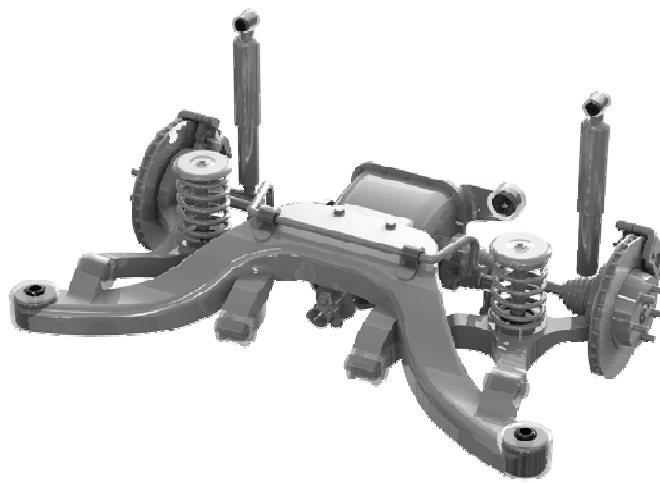
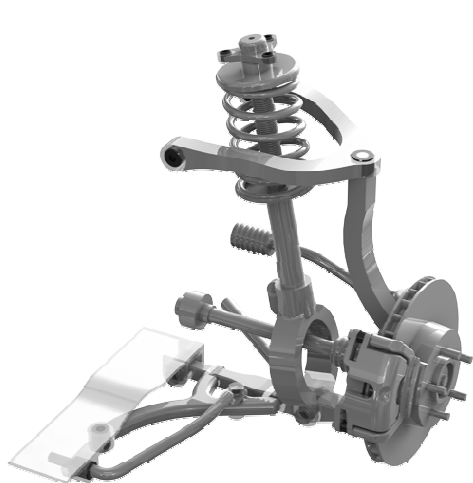

Aplicaci...	Descripción	Referencia	Kits por...	Contenido del Kit	
DEL.	Control Arm Lower-Inner Bushing Re-use original shell	<b>MPU-0509K</b>	1	Inner Tubes, Bushings	
DEL.	Steering Rack & Pinion Mount Bushing	<b>MPU-3480K</b>	1	Inst Sheet, Bushings	
DEL.	Strut Bar To Chassis Mount Kit	<b>MPU-0307K</b>	1	Bushings	
DEL.	Sway Bar Link Bushing Kit	<b>MPU-0903K</b>	1	Bushings	
DEL.	Sway Bar Mount To Chassis Bushing Measure bar diameter 12mm to 30mm available	<b>MPU-1450-__K</b>	1	Bushings	
TRAS.	Control Arm Lower-Inner & Outer Kit IRS rear suspension, Remove original shell for fitment, 70mm long tubes inner & 65mm tubes outer	<b>MPU-3180K</b>	1	Inner Tubes, Bushings	
TRAS.	Control Arm-Inner Bushing IRS Suspension, 4 x 70mm long crush tubes, Must re-use original shell	<b>MPU-1213K</b>	1	Inner Tubes, Bushings	



## TOYOTA Supra MA60, MA61, SA61 - 12/1981 - 1985

Página 2 (Continúa)









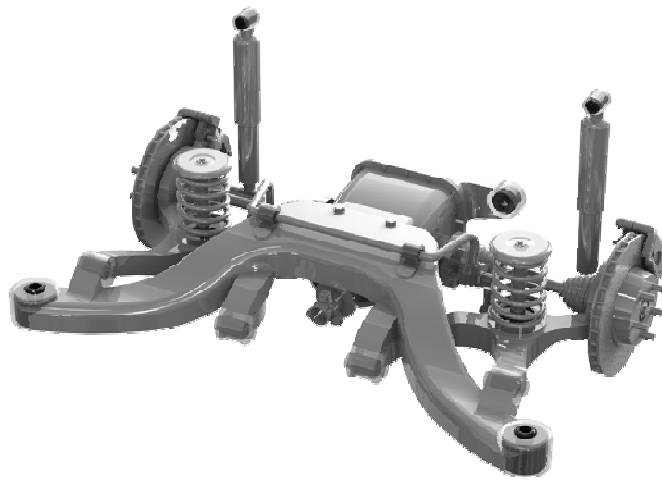
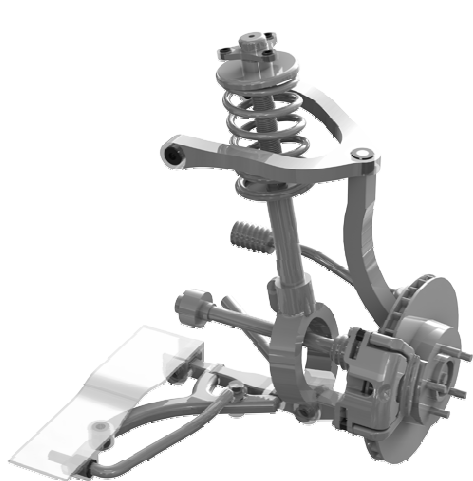

Aplicaci...	Descripción	Referencia	Kits por...	Contenido del Kit	
TRAS.	Cross-member To Chassis Mount Front of cross-member bushing kit	<b>MPU-1447K</b>	1	Inner Tubes, Bushings	 SPF1447K
TRAS.	Cross-member To Chassis Mount Rear of cross-member bushing kit, IRS Vehicles, Replaces upper original mount 5228214010 and lower...	<b>MPU-2926K</b>	1	Inner Tubes, Bushings	 SPF2926K
TRAS.	Shock Absorber Lower Bushing	<b>MPU-2178-16K</b>	1	Bushings	 SPF2178- K
TRAS.	Shock Absorber Upper Bushing	<b>MPU-2755SK</b>	1	Bushings	 SPF2755SK
TRAS.	Sway Bar Link Lower Bushing	<b>MPU-0280K</b>	1	Inner Tubes, Bushings	 SPF0280K
TRAS.	Sway Bar Link Upper Bushing	<b>MPU-0903-4K</b>	1	Bushings	 0903-4K



## TOYOTA Supra JZA70, MA70, MA71 - 3/1986 - 12/1992

Página 1





Aplicaci...	Descripción	Referencia	Kits por...	Contenido del Kit	
DEL.	Control Arm Lower-Inner Bushing Bushes with moulded washers fit to front eye	<b>MPU-1443K</b>	1	Washers, Inner Tubes, Bushings	
DEL.	Control Arm Upper-Inner Kit	<b>MPU-1576K</b>	1	Bushings, Inner Tubes, Washers	
DEL.	Sway Bar Mount Bushing Measure bar diameter 27 & 30mm available	<b>MPU-2921-__K</b>	1	Bushings	
TRAS.	Control Arm Lower-Inner & Outer Kit	<b>MPU-4061K</b>	1	Inner Tubes, Bushings	
TRAS.	Control Arm Upper-Inner Bushing	<b>MPU-4062K</b>	1	Inner Tubes, Bushings	
TRAS.	Subframe to Chassis Mount Bush Kit	<b>MPU-4065K</b>	1	Outer Shells, Inner Tubes, Bushings	
TRAS.	Toe Control Arm - Inner Bushing	<b>MPU-4064K</b>	1	Inner Tubes, Bushings	

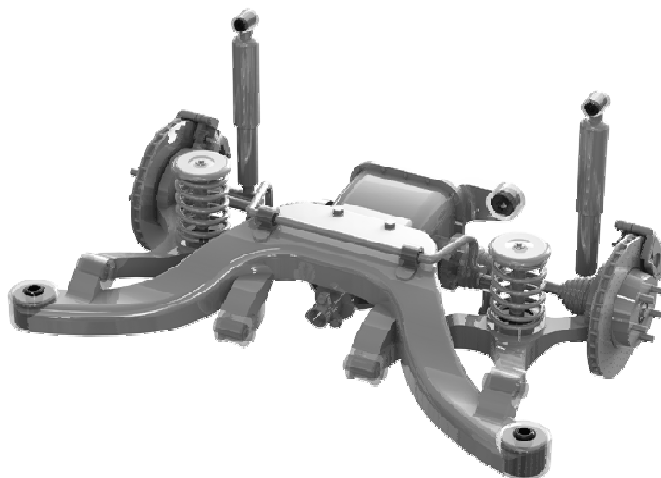
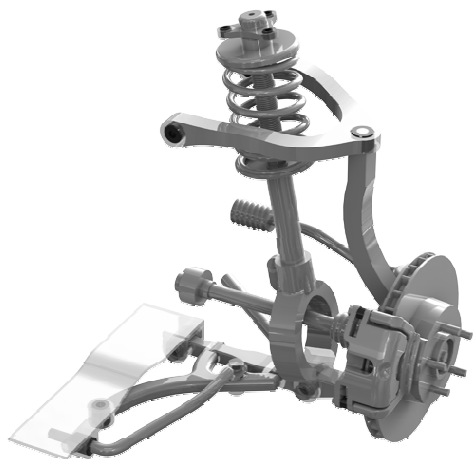

**TOYOTA Supra JZA70, MA70, MA71 - 3/1986 - 12/1992**

Página 2 (Continúa)









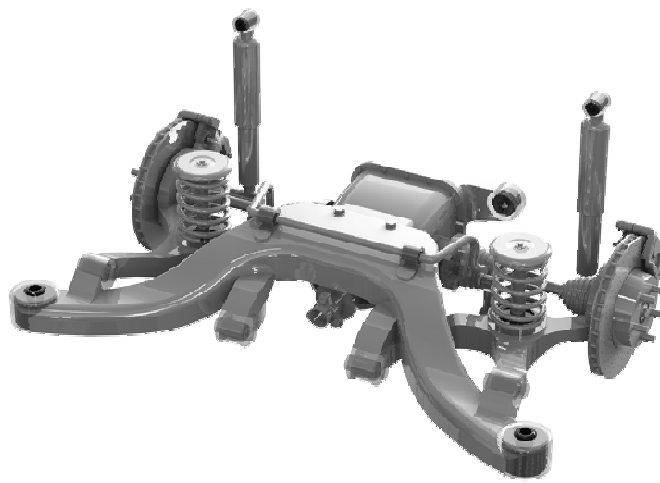
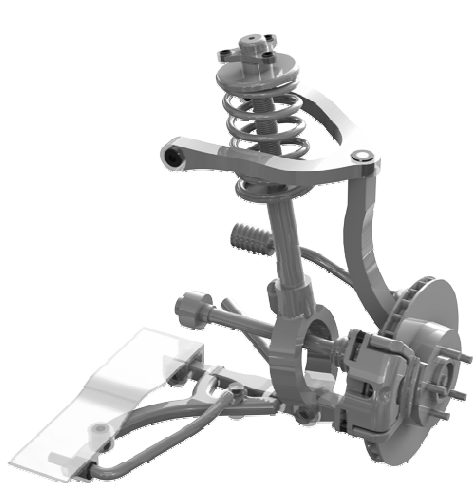

Aplicaci...	Descripción	Referencia	Kits por...	Contenido del Kit	
TRAS.	Trailing Arm - Front Bushing	<b>MPU-4063K</b>	1	Inner Tubes, Bushings	



## TOYOTA Supra JZA80 - 5/1993 - 8/1998

Página 1



Aplicaci...	Descripción	Referencia	Kits por...	Contenido del Kit	
DEL.	Control Arm Lower Rear Bushing Early model, up to 5/1996, Bush OD = 54.8mm	<b>MPU-1404K</b>	1	Bushings, Inner Tubes	
DEL.	Control Arm Lower Rear Bushing Late model, 5/1996 on, Bush OD = 51.1mm	<b>MPU-1651K</b>	1	Inner Tubes, Bushings	
DEL.	Control Arm Lower-Front Bushing Early model, up to 5/1996, Bush OD = 49.5mm	<b>MPU-1403K</b>	1	Inner Tubes, Bushings	
DEL.	Control Arm Lower-Front Bushing Late model, 5/1996 on, Bush OD = 46mm	<b>MPU-1650K</b>	1	Inner Tubes, Bushings	
DEL.	Control Arm Upper-Inner Kit Must measure housing, suits 20mm wide housing	<b>MPU-1352K</b>	1	Bushings, Inner Tubes	
DEL.	Control Arm Upper-Inner Kit Must measure housing, suits 38mm wide housing	<b>MPU-1474K</b>	1	Inner Tubes, Bushings	
DEL.	Steering Rack & Pinion Mount Bushing Replaces OE#45517-14040,suited to vehicles with steering rack housing outside diameter...	<b>MPU-1193-47K</b>	1	Inner Tubes, Bushings	









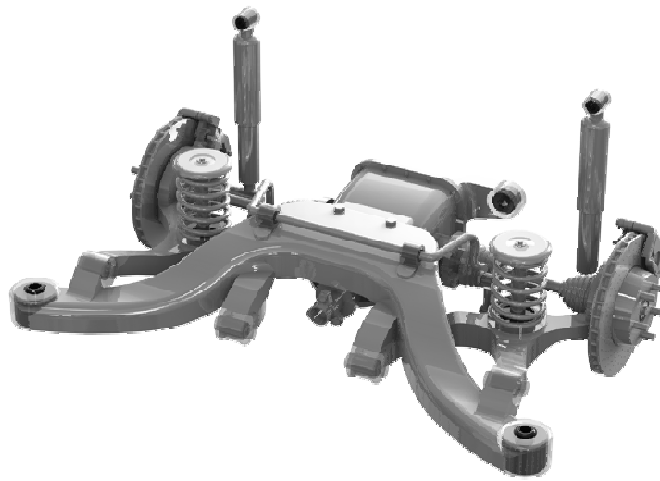
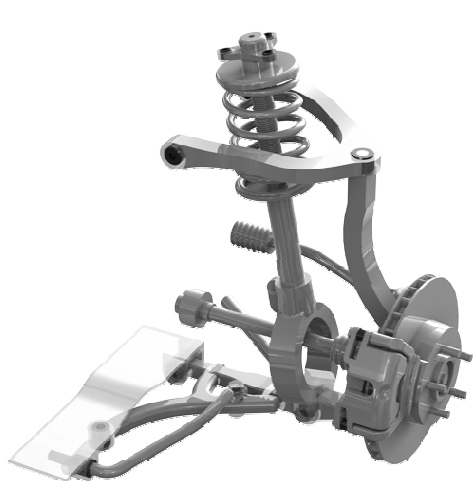



## TOYOTA Supra JZA80 - 5/1993 - 8/1998

Página 2 (Continúa)









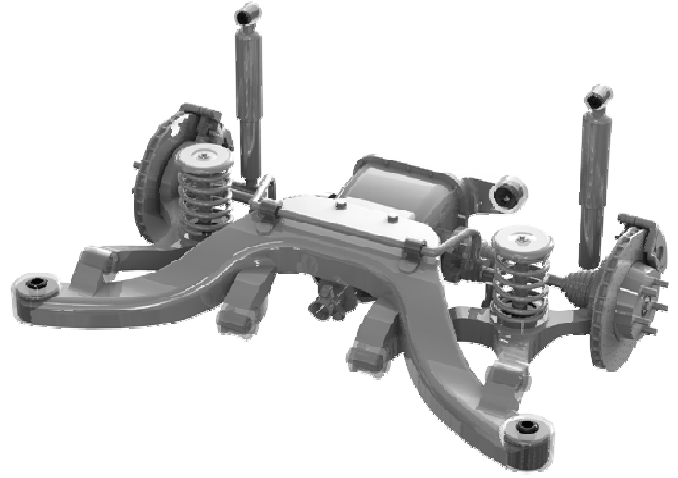
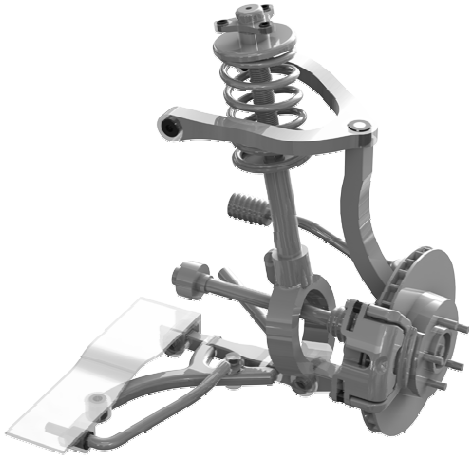

Aplicaci...	Descripción	Referencia	Kits por...	Contenido del Kit	
DEL.	Steering Rack & Pinion Mount Bushing Replaces OE#45517-24030,suited to vehicles with steering rack housing outside diameter...	<b>MPU-1193-50K</b>	1	Inner Tubes, Bushings	
DEL.	Sway Bar Mount To Chassis Bushing Suits bracket height of 42mm, Measure bar diameter 24,25,26,27,28,29,30,32mm available	<b>MPU-0342-__K</b>	1	Bushings	
DEL.	Sway Bar Mount To Chassis Bushing Suits bracket height of 44mm, Bar diameter 24,27,30mm available	<b>MPU-1512-__K</b>	1	Bushings	
DEL.	Sway Bar Mount To Chassis Bushing Suits bracket height of 49mm, Measure bar diameter 21,22,23,24,27,28,30,32mm available	<b>MPU-1846-__K</b>	1	Bushings	
TRAS.	Control Arm Lower-Inner Bushing	<b>MPU-3032K</b>	1	Inner Tubes, Bushings	
TRAS.	Control Arm Lower-Shock Mount Kit	<b>MPU-3033K</b>	1	Inner Tubes, Bushings	
TRAS.	Control Arm Upper-Inner Kit Remove outer shells	<b>MPU-1922K</b>	1	Inner Tubes, Bushings	



## TOYOTA Supra JZA80 - 5/1993 - 8/1998

Página 3 (Continúa)





Aplicaci...	Descripción	Referencia	Kits por...	Contenido del Kit	
TRAS.	Cross-member Supplement Washers Front Mount	<b>MPU-2553K</b>	1	Bushings	
TRAS.	Cross-member Supplement Washers Rear mount, to be fitted into original bushing	<b>MPU-2520K</b>	1	Washers, Bushings	
TRAS.	Differential Pinion Mount Bushing Upper is replacement bushing, lower is insert to original rubber bushing	<b>MPU-2769K</b>	1	Washers, Bushings	
TRAS.	Sub Frame Rear Bushing Replaces original bushing	<b>MPU-3269K</b>	1	Washers, Outer Shells, Inner Tubes, Bushings	
TRAS.	Sway Bar Mount Bushing Bar diameter required, 15,16,17,18,19,20,21,22,23,24,25 & 27mm	<b>MPU-1487-__K</b>	1	Bushings	
TRAS.	Toe Control Arm - Inner Bushing Note	<b>MPU-3034K</b>	1	Inner Tubes, Bushings	
TRAS.	Trailing Arm - Front Bushing	<b>MPU-3030K</b>	1	Inner Tubes, Bushings	

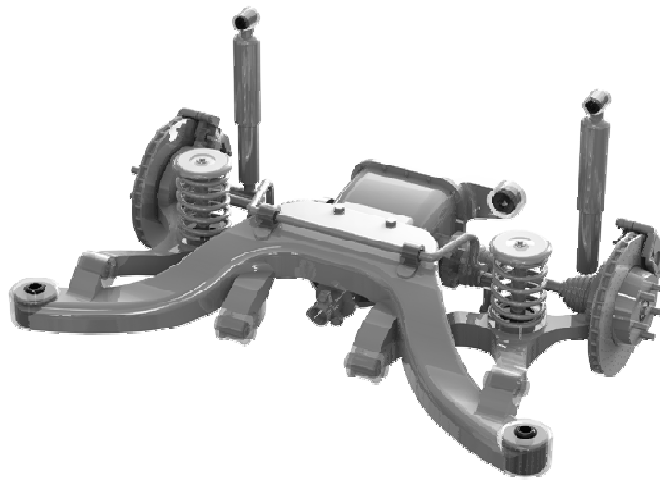
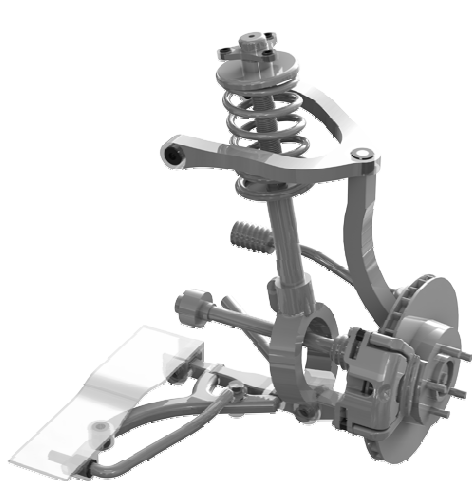

**TOYOTA Supra JZA80 - 5/1993 - 8/1998**

Página 4 (Continúa)





Aplicaci...	Descripción	Referencia	Kits por...	Contenido del Kit	
TRAS.	Trailing Arm - Rear Bushing Bushing located in hub	<b>MPU-3031K</b>	1	Inner Tubes, Bushings	

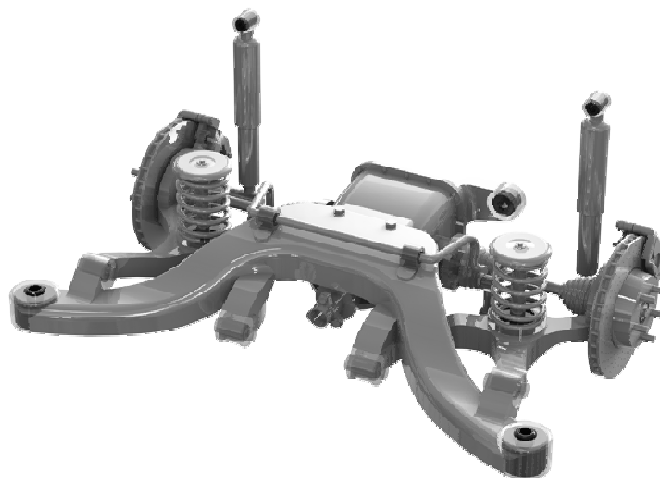
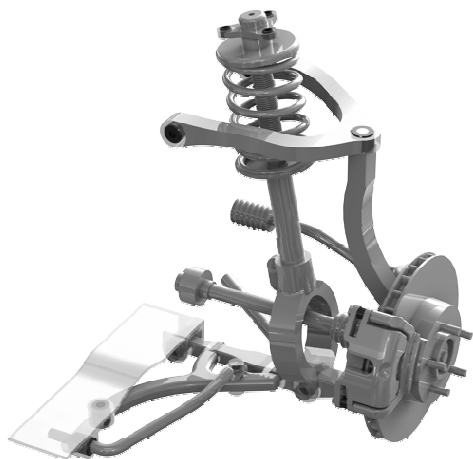

**TOYOTA Soarer Coupe GZ20 - 1988 - 1990**

Página 1





Aplicaci...	Descripción	Referencia	Kits por...	Contenido del Kit	
DEL.	Control Arm Lower-Inner Bushing Bushes with moulded washers fit to front eye	<b>MPU-1443K</b>	1	Washers, Inner Tubes, Bushings	

**TOYOTA Soarer GZ10, MZ10 - 1981 - 1985**

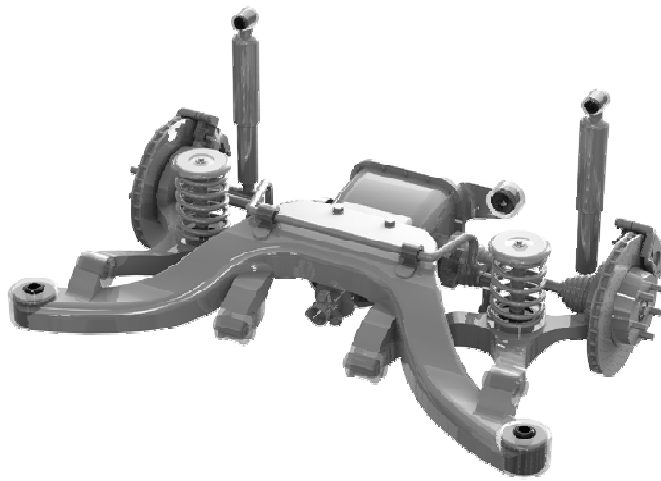
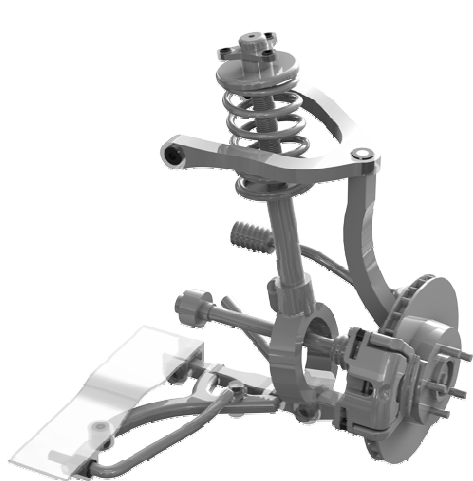
Página 1









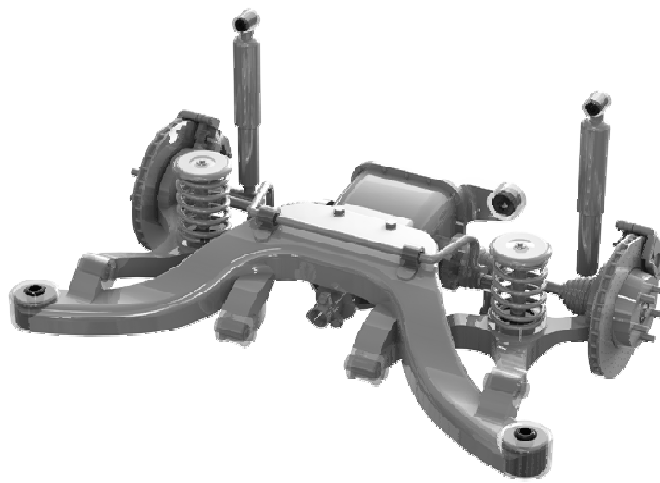
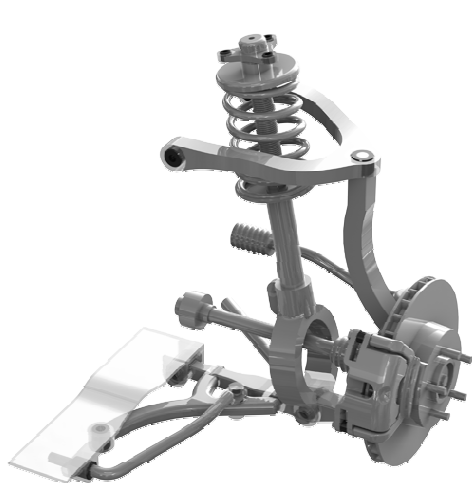

Aplicaci...	Descripción	Referencia	Kits por...	Contenido del Kit	
TRAS.	Control Arm Lower-Inner & Outer Kit Remove OE shell for fitment, 70mm long tubes inner & 65mm tubes outer	<b>MPU-3180K</b>	1	Inner Tubes, Bushings	



## TOYOTA Soarer Coupe - 1/1990 - 1997

Página 1









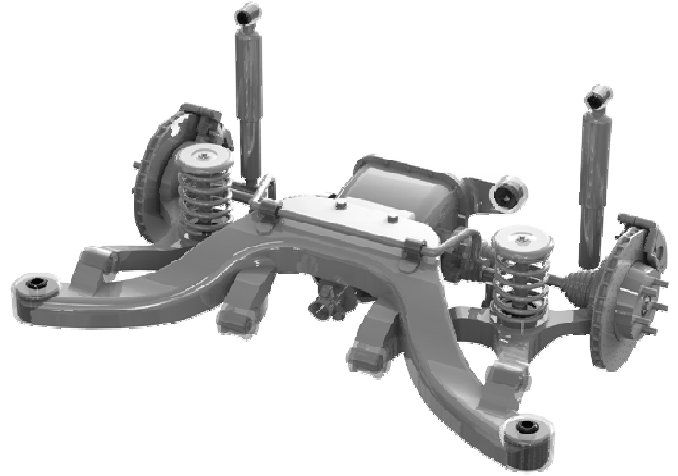
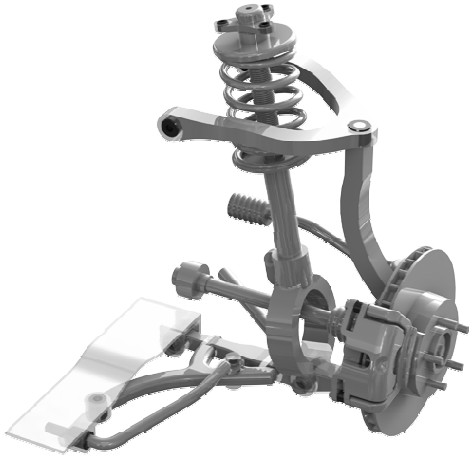

Aplicaci...	Descripción	Referencia	Kits por...	Contenido del Kit	
DEL.	Control Arm Lower Rear Bushing Early model, Bush OD = 54.8mm	<b>MPU-1404K</b>	1	Bushings, Inner Tubes	
DEL.	Control Arm Lower Rear Bushing Late model, bush OD = 51.1mm	<b>MPU-1651K</b>	1	Inner Tubes, Bushings	
DEL.	Control Arm Lower-Front Bushing Early model, Bush OD = 49.5mm	<b>MPU-1403K</b>	1	Inner Tubes, Bushings	
DEL.	Control Arm Lower-Front Bushing Late model, bush OD = 46mm	<b>MPU-1650K</b>	1	Inner Tubes, Bushings	
DEL.	Control Arm Upper-Inner Kit Measure housing, this kit suits 20mm wide	<b>MPU-1352K</b>	1	Bushings, Inner Tubes	
DEL.	Control Arm Upper-Inner Kit Measure housing, this kit suits 38mm wide	<b>MPU-1474K</b>	1	Inner Tubes, Bushings	
DEL.	Steering Rack & Pinion Mount Bushing Replaces OE#45517-24030,suited to vehicles with steering rack housing outside diameter...	<b>MPU-1193-50K</b>	1	Inner Tubes, Bushings	



**TOYOTA Soarer Coupe - 1/1990 - 1997**

Página 2 (Continúa)







Aplicaci...	Descripción	Referencia	Kits por...	Contenido del Kit	
DEL.	Steering Rack & Pinion Mount Bushing Replaces OE#45517-14040,suited to vehicles with steering rack housing outside diameter...	<b>MPU-1193-47K</b>	1	Inner Tubes, Bushings	
DEL.	Sway Bar Mount To Chassis Bushing Suits bracket height of 42mm, Measure bar diameter 24,25,26,27,28,29,30,32mm available	<b>MPU-0342-__K</b>	1	Bushings	
DEL.	Sway Bar Mount To Chassis Bushing Suits bracket height of 44mm, Bar diameter 24,27,30mm available	<b>MPU-1512-__K</b>	1	Bushings	
DEL.	Sway Bar Mount To Chassis Bushing Suits bracket height of 49mm, Measure bar diameter 21,22,23,24,27,28,30,32mm available	<b>MPU-1846-__K</b>	1	Bushings	
TRAS.	Control Arm Upper-Inner Kit Remove outer shells	<b>MPU-1922K</b>	1	Inner Tubes, Bushings	
TRAS.	Cross-member Supplement Washers Rear mount, to be fitted into original bushing	<b>MPU-2520K</b>	1	Washers, Bushings	
TRAS.	Cross-member Supplement Washers Front mount	<b>MPU-2553K</b>	1	Bushings	

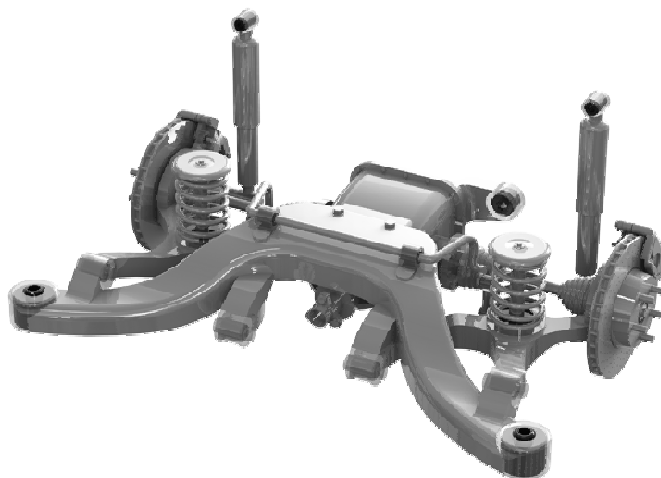
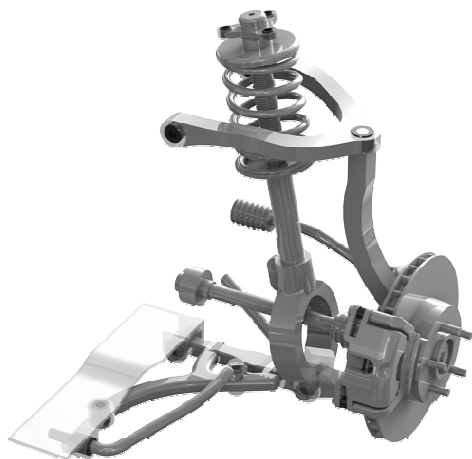

**TOYOTA Soarer Coupe - 1/1990 - 1997**

Página 3 (Continúa)

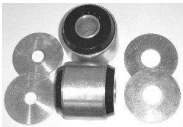

Aplicaci...	Descripción	Referencia	Kits por...	Contenido del Kit	
TRAS.	Sub Frame Rear Bushing Replaces original bushing	<b>MPU-3269K</b>	1	Washers, Outer Shells, Inner Tubes, Bushings	
TRAS.	Sway Bar Mount To Chassis Bushing Suits bracket height of 42mm, Measure bar diameter 24,25,26,27,28,29,30,32mm available	<b>MPU-0342-__K</b>	1	Bushings	





## TOYOTA Prado 70 Series LWB & SWB - 1988 - 1995

Página 1

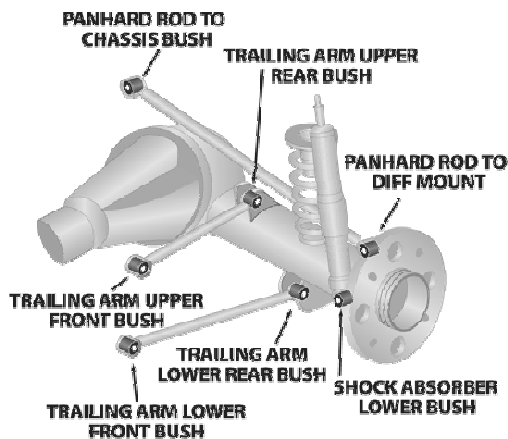
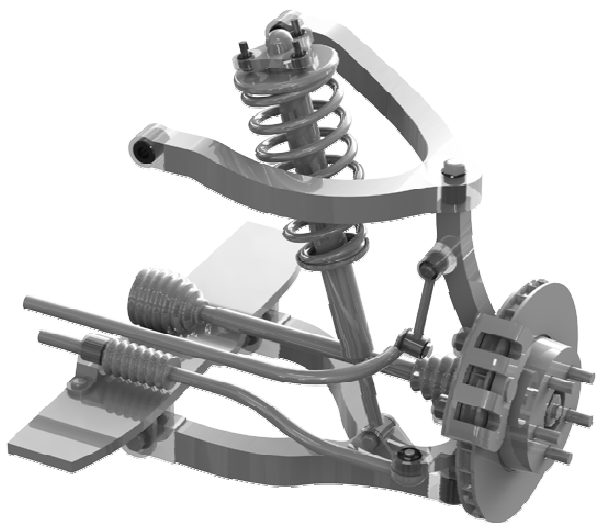







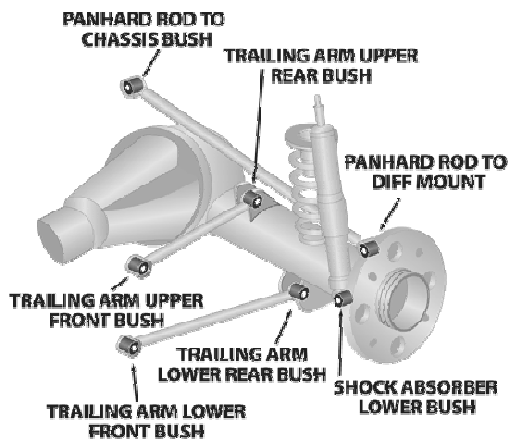
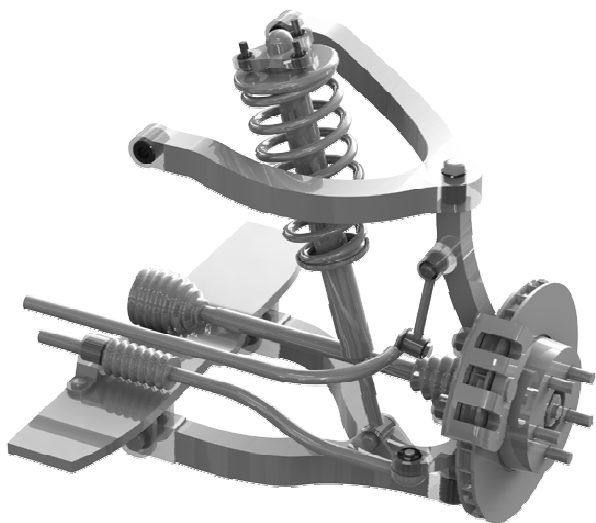

Aplicaci...	Descripción	Referencia	Kits por...	Contenido del Kit	
DEL.	Panhard Rod Bushing	<b>MPU-1222K</b>	1	Bushings, Inner Tubes, Washers	
DEL.	Radius Arm To - Diff Mount - Eccentric Kit Offset centre hole to increase caster settings	<b>MPU-1721K</b>	1	Inst Sheet, Outer Shells, Inner Tubes, Bushings	
DEL.	Radius Arm To - Diff Mount - Eccentric Kit Extra offset "High Lift Vehicles" To increase caster settings	<b>MPU-1721XK</b>	1	Inst Sheet, Outer Shells, Inner Tubes, Bushings	
DEL.	Radius Arm To - Diff Mount Bushing	<b>MPU-0396K</b>	1	Inner Tubes, Bushings	
DEL.	Radius Arm To Chassis Mount Bushing 40mm wide arm	<b>MPU-1909K</b>	1	Inner Tubes, Bushings	
DEL.	Radius Arm To Chassis Mount Bushing 35mm wide arm, replaces OE# 48061-60020	<b>MPU-2431K</b>	1	Bushings, Inner Tubes	
DEL.	Shock Absorber Lower Bushing	<b>MPU-2755SK</b>	1	Bushings	



## TOYOTA Prado 70 Series LWB & SWB - 1988 - 1995

Página 2 (Continúa)



Aplicaci...	Descripción	Referencia	Kits por...	Contenido del Kit	
DEL.	Sway Bar Mount Bushing Replaces OE # 48815 -60040, Bar diameter 16,20,21,22,23,24,25,26,27,28 & 29mm...	MPU-1486-__K	1	Bushings	
DEL.	Sway Bar To Lower Control Arm Kit Measure bar diameter 14,15 & 17mm available	MPU-2011-__K	1	Bushings	
F & R	Radius Arms & Panhard Rods Bush Kit Adjustable kit, & as per information above on KIT088K	MPK-088ADJK	1		
F & R	Radius Arms & Panhard Rods Bush Kit 40 wide radius arm, Rear panhard rod = 1 end cotton reel & 1 end hour glass	MPK-088K	1		
F & R	Radius Arms & Panhard Rods Bush Kit Adjustable kit, & as per notes above on KIT091K	MPK-091ADJK	1		
F & R	Radius Arms & Panhard Rods Bush Kit 35mm wide radius arm,Rear p/hard cotton reel 2 x ends	MPK-091K	1		
TRAS.	Panhard Rod Bushing Cotton reel style to chassis, Hour glass style to diff	MPU-1908K	1	Washers, Inner Tubes, Bushings	



## TOYOTA Prado 70 Series LWB & SWB - 1988 - 1995

Página 3 (Continúa)

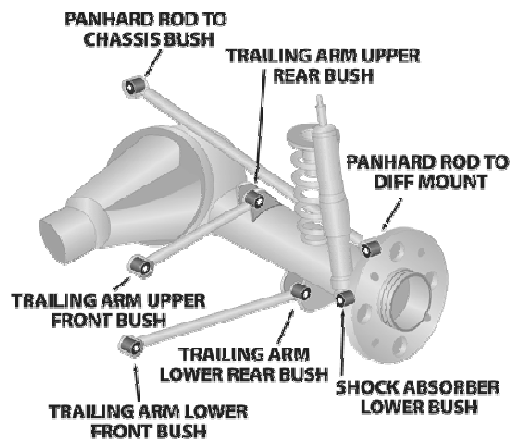
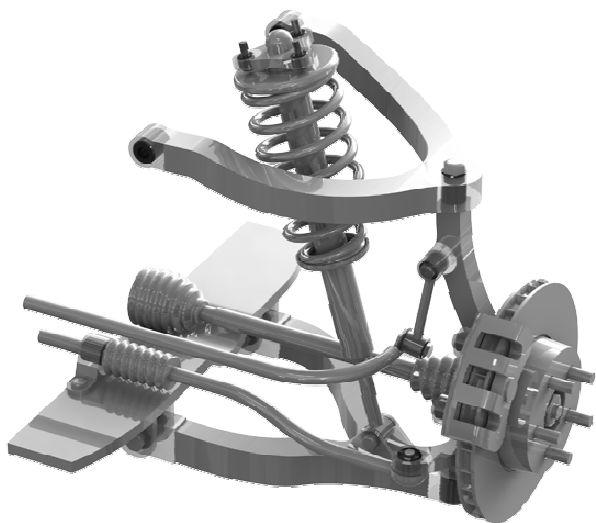



Aplicaci...	Descripción	Referencia	Kits por...	Contenido del Kit	
TRAS.	Panhard Rod Bushing Replaces OE# 48706-60050,Cotton reel style both ends	<b>MPU-2405K</b>	1	Bushings, Inner Tubes	
TRAS.	Radius Arm To - Diff Mount Bushing	<b>MPU-0396K</b>	1	Inner Tubes, Bushings	
TRAS.	Radius Arm To Chassis Mount Bushing 40mm wide arm	<b>MPU-1909K</b>	1	Inner Tubes, Bushings	
TRAS.	Radius Arm To Chassis Mount Bushing 35mm wide arm, replaces OE# 48061-60020	<b>MPU-2431K</b>	1	Bushings, Inner Tubes	
TRAS.	Shock Absorber Lower Bushing	<b>MPU-2755SK</b>	1	Bushings	
TRAS.	Shock Absorber Upper Bushing	<b>MPU-0066-19K</b>	1	Bushings	
TRAS.	Sway Bar Link Bushing Kit	<b>MPU-0280K</b>	1	Inner Tubes, Bushings	

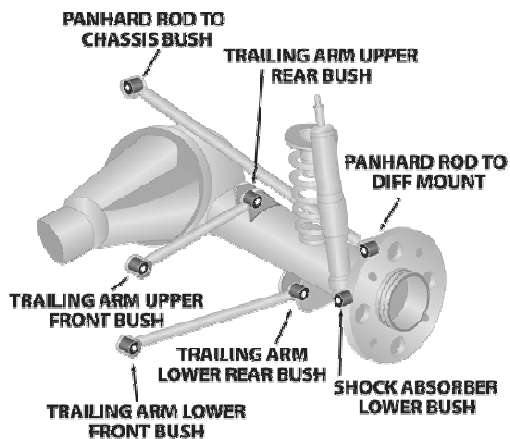
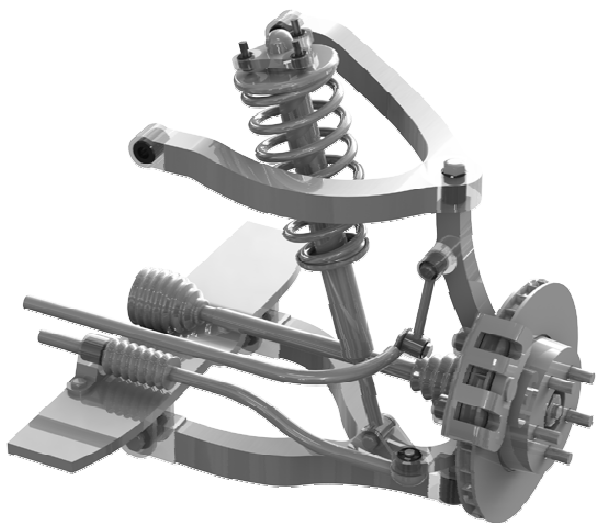

**TOYOTA Prado 70 Series LWB & SWB - 1988 - 1995**

Página 4 (Continúa)



Aplicaci...	Descripción	Referencia	Kits por...	Contenido del Kit	
TRAS.	Sway Bar Mount Bushing Measure bar diameter 16,20,21,22,23,24,25,26,27,28 & 29mm available	MPU-1486-__K	1	Bushings	



**TOYOTA Prado 120 Series LWB & SWB - 2/2003 - 2008**

Página 1

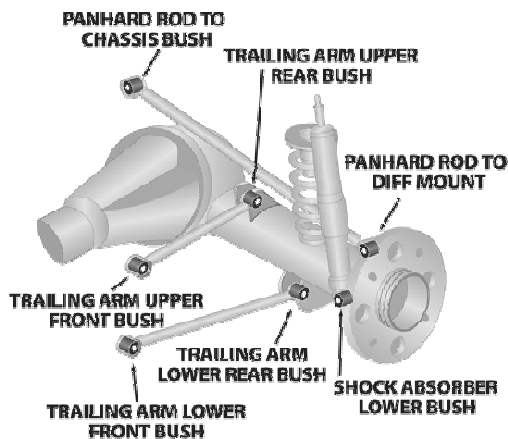
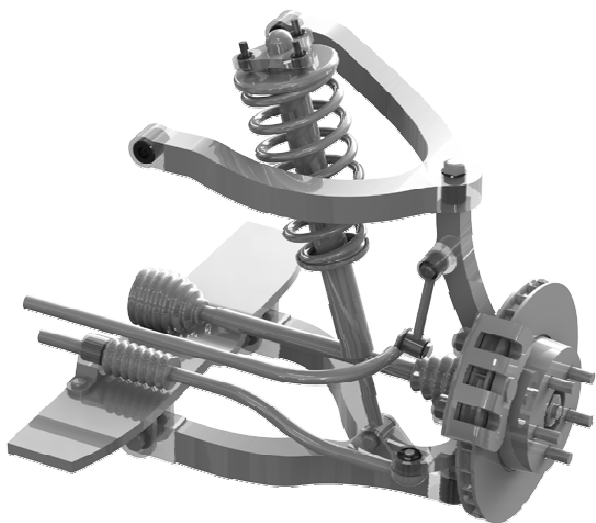

Aplicaci...	Descripción	Referencia	Kits por...	Contenido del Kit	
DEL.	Control Arm Lower-Inner Front & Rear CONTENTS - SPF2834K x 1, SPF2835K x 1	<b>MPK-180K</b>	1	Washers, Outer Shells, Inner Tubes, Bushings	
DEL.	Control Arm Lower-Inner Front Kit Replaces original shell part	<b>MPU-2834K</b>	1	Washers, Outer Shells, Inner Tubes, Bushings	
DEL.	Control Arm Lower-Inner Rear Kit Replaces original part number 48655-60030	<b>MPU-2835K</b>	1	Washers, Outer Shells, Inner Tubes, Bushings	
DEL.	Control Arm Upper-Inner Eccentric Kit Offset tube in kit for Camber Decrease on raised vehicles, Remove original shell for fitment	<b>MPU-3230K</b>	1	Inst Sheet, Washers, Inner Tubes, Bushings	
DEL.	Control Arm Upper-Inner Kit Standard replacement, Remove original shell for fitment	<b>MPU-2845K</b>	1	Washers, Inner Tubes, Bushings	
DEL.	Shock Absorber Lower Bushing	<b>MPU-3591K</b>	1	Outer Shells, Inner Tubes, Bushings	
DEL.	Steering Rack & Pinion Mount Bush.....Power Steering	<b>MPU-3144K</b>	1	Washers, Inner Tubes, Bushings	



TOYOTA Prado 120 Series LWB & SWB - 2/2003 - 2008

Página 2 (Continúa)

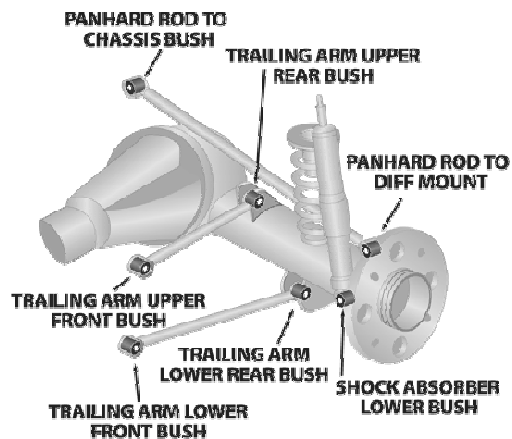
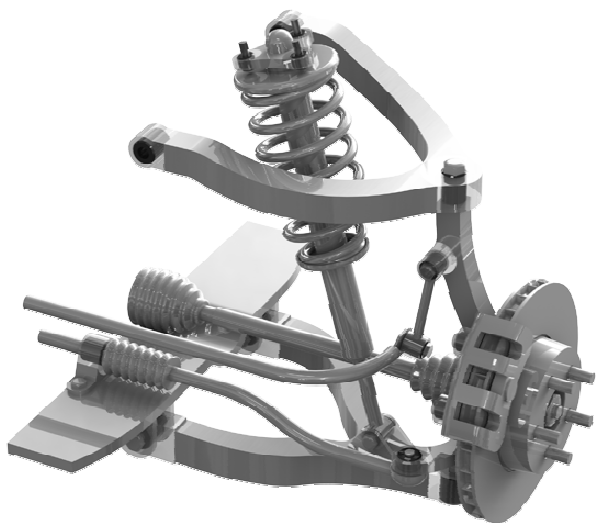







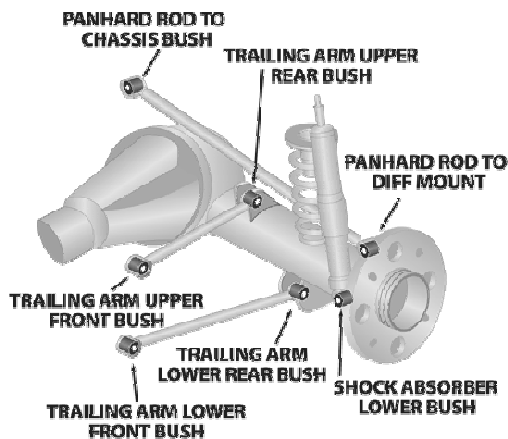
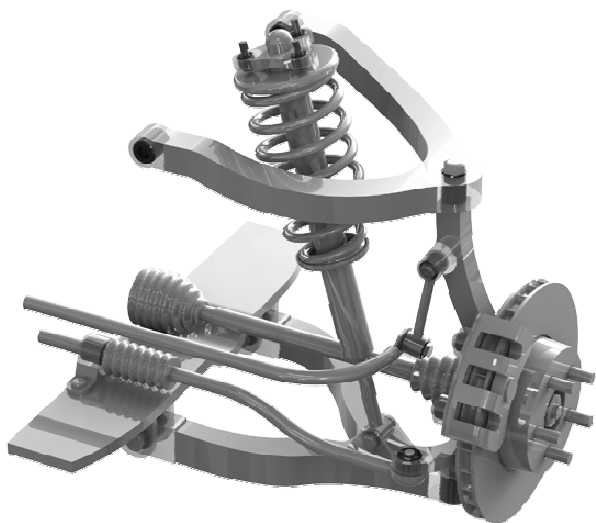

Aplicaci...	Descripción	Referencia	Kits por...	Contenido del Kit	
DEL.	Sway Bar Mount To Chassis Bushing Measure bar diameter, 19, 29mm available	MPU-2506-__K	1	Bushings	
TRAS.	Panhard Rod Bushing Replaces both ends of the bar	MPU-2836K	1	Inner Tubes, Bushings	
TRAS.	Sway Bar Mount To Chassis Bushing Measure bar diameter, 15,16,17,18,19,20,21,22,23,24,25 & 27mm	MPU-1487-__K	1	Bushings	
TRAS.	Trailing Arm Lower Bushing All	MPU-2461K	2	Inner Tubes, Bushings	
TRAS.	Trailing Arm Upper Bushing All	MPU-1760K	2	Inner Tubes, Bushings	



TOYOTA Prado 95 Series LWB & SWB - 7/1996 - 1/2003

Página 1









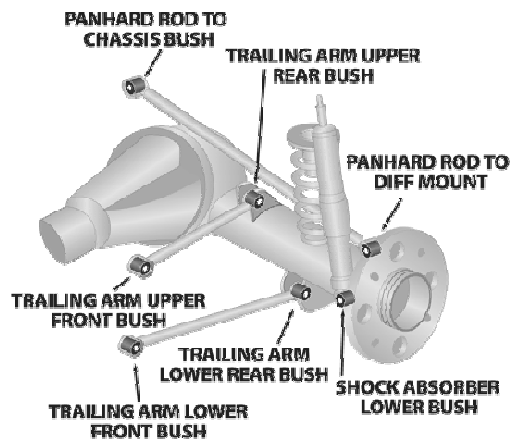
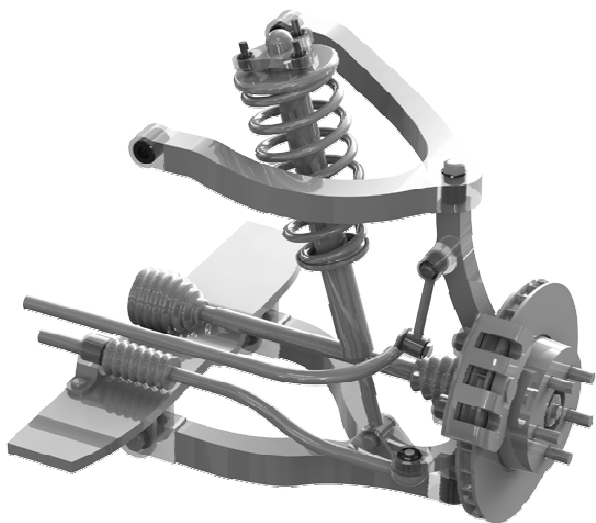

Aplicaci...	Descripción	Referencia	Kits por...	Contenido del Kit	
DEL.	Control Arm Lower-Inner Front Kit Replaces OE # 48061-35040	<b>MPU-2711K</b>	1	Washers, Outer Shells, Inner Tubes, Bushings	
DEL.	Control Arm Lower-Inner Rear Kit Replaces OE # 48061-35050	<b>MPU-2712K</b>	1	Washers, Outer Shells, Inner Tubes, Bushings	
DEL.	Control Arm Upper-Inner Kit Replaces OE # 48632-35080	<b>MPU-2713K</b>	1	Outer Shells, Inner Tubes, Bushings	
DEL.	Shock Absorber Lower Bushing	<b>MPU-3591K</b>	1	Outer Shells, Inner Tubes, Bushings	
DEL.	Shock Absorber Upper Bushing Suits Aftermarket shock only with 12mm pin and stud length of 72.5mm	<b>MPU-2507K</b>	1	Bushings	
DEL.	Steering Rack & Pinion Mount Bush.....Power Steering Both RH & LH sides of rack	<b>MPU-1836K</b>	1	Washers, Inner Tubes, Bushings	
DEL.	Sway Bar Link Bushing Kit	<b>MPU-2755SK</b>	1	Bushings	



## TOYOTA Prado 95 Series LWB & SWB - 7/1996 - 1/2003

Página 2 (Continúa)



Aplicaci...	Descripción	Referencia	Kits por...	Contenido del Kit	
DEL.	Sway Bar Mount To Chassis Bushing Replaces OE # 48815-60100, Bar diameter 16,20,21,22,23,24,25,26,27,28 & 29mm...	<b>MPU-1486-__K</b>	1	Bushings	
TRAS.	Panhard Rod Bushing	<b>MPU-1488K</b>	1	Inner Tubes, Bushings	
TRAS.	Radius Arms & Panhard Rods Bush Kit	<b>MPK-092RK</b>	1		
TRAS.	Shock Absorber Upper Bushing	<b>MPU-0201K</b>	1	Bushings	
TRAS.	Sway Bar Link Bushing Kit	<b>MPU-2092B-4K</b>	1	Bushings	
TRAS.	Sway Bar Mount To Axle Bushing Replaces OE # 48815-16170 Bar diameter required	<b>MPU-1487-__K</b>	1	Bushings	
TRAS.	Trailing Arm Lower Bushing All	<b>MPU-1489K</b>	1	Inner Tubes, Bushings	





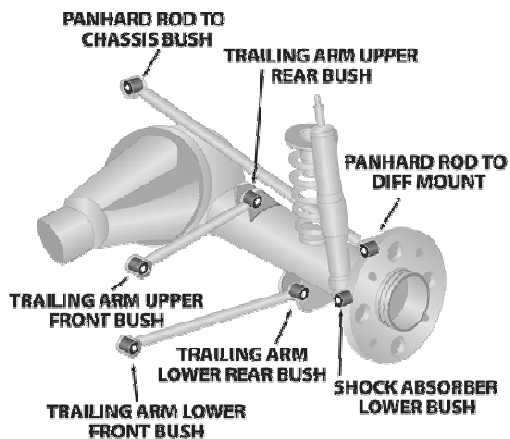
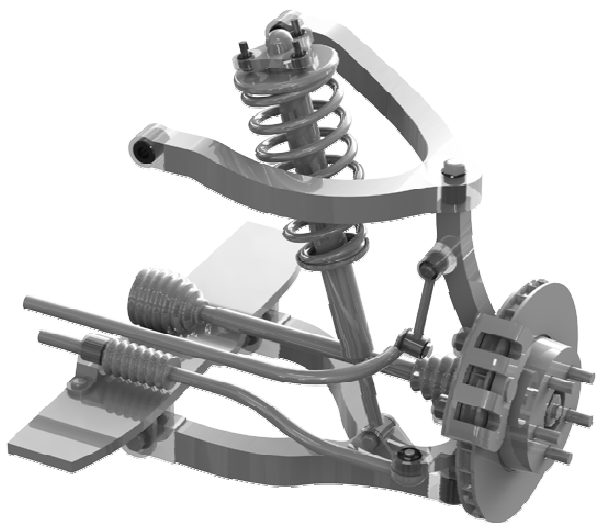

**TOYOTA Prado 95 Series LWB & SWB - 7/1996 - 1/2003**

Página 3 (Continúa)





Aplicaci...	Descripción	Referencia	Kits por...	Contenido del Kit	
TRAS.	Trailing Arm Upper Bushing All	<b>MPU-1490K</b>	1	Inner Tubes, Bushings	 1490K

**TOYOTA Carina AA63,TA61,TA63,RA63, - 1981 - 1985**

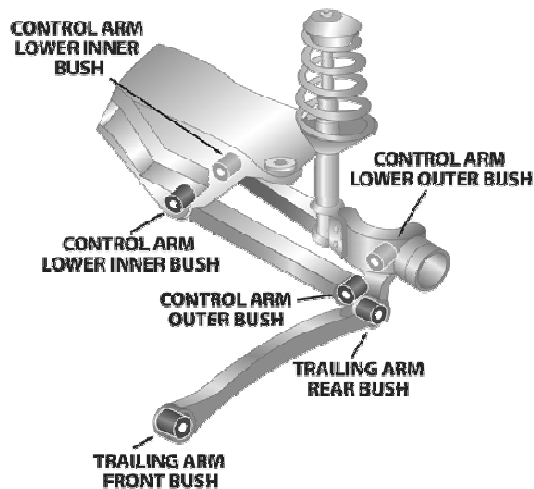
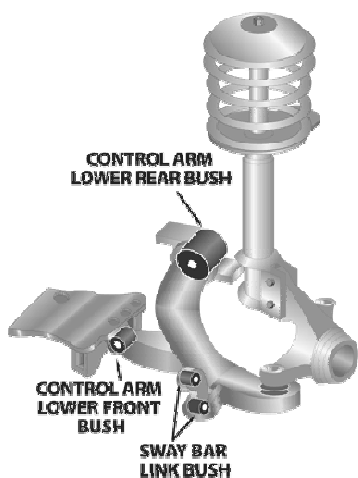
Página 1



Aplicaci...	Descripción	Referencia	Kits por...	Contenido del Kit	
TRAS.	Control Arm Lower-Inner & Outer Kit Remove OE shell for fitment, 70mm long tubes inner & 65mm tubes outer	<b>MPU-3180K</b>	1	Inner Tubes, Bushings	



TOYOTA Paseo EL44 / EL54 - 6/1991 - 07/1999

Página 1

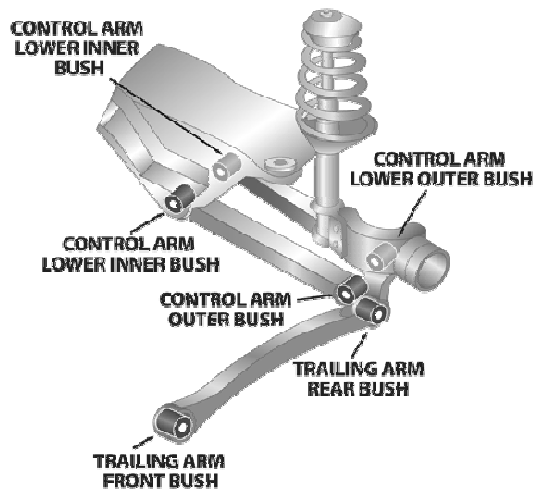
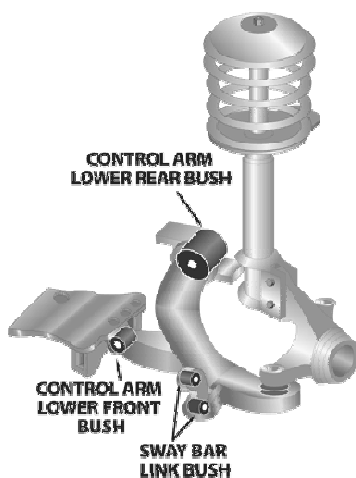





Aplicaci...	Descripción	Referencia	Kits por...	Contenido del Kit	
DEL.	Control Arm Lower-Inner Front Kit Must measure, 34mm OD bush	<b>MPU-1888K</b>	1	Bushings, Inner Tubes	
DEL.	Control Arm Lower-Inner Front Kit Must measure, 31mm OD bush	<b>MPU-1905K</b>	1	Bushings, Inner Tubes	
DEL.	Control Arm Lower-Inner Rear Kit Suits 335mm long mounting bracket,OE # 48652-46010, Do not remove original tube from arm	<b>MPU-2635K</b>	1	Bushings	

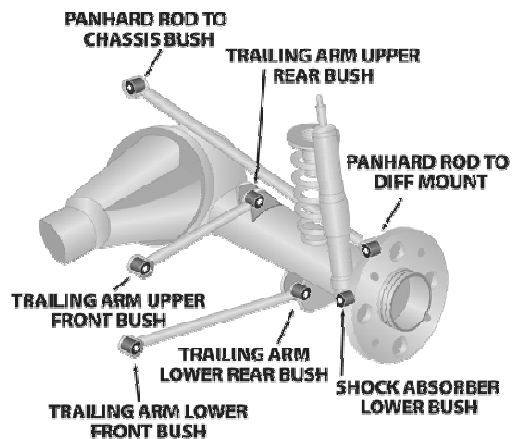
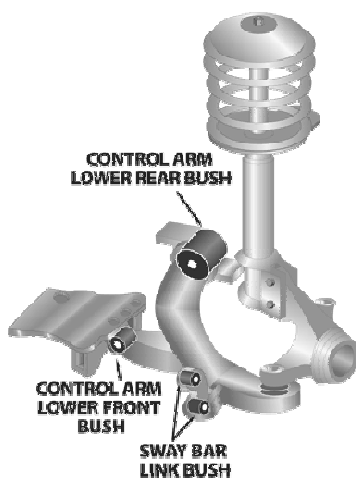

**TOYOTA Rav 4 XA10, 3 & 5 Door - 7/1994 - 6/2000**

Página 1









Aplicaci...	Descripción	Referencia	Kits por...	Contenido del Kit	
DEL.	Steering Rack & Pinion Mount Bushing	<b>MPU-2487K</b>	1	Bushings, Inner Tubes	
DEL.	Sway Bar Mount Bushing Measure bar diameter 12mm to 30mm available	<b>MPU-1450-__K</b>	1	Bushings	

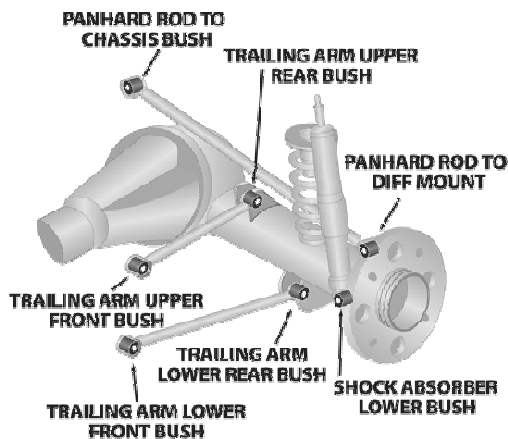
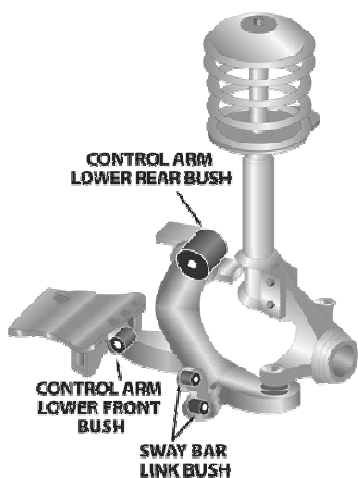

TOYOTA Rav 4 XA20 Series - 7/2000 - 4/2005

Página 1









Aplicaci...	Descripción	Referencia	Kits por...	Contenido del Kit	
DEL.	Control Arm Lower-Inner Front Kit	MPU-0996K	1	Inner Tubes, Bushings	
DEL.	Control Arm Lower-Inner Rear Eccentric Single offset	MPU-2086K	1	Outer Shells, Inner Tubes, Bushings	
DEL.	Control Arm Lower-Inner Rear Eccentric Double offset	MPU-2087K	1	Outer Shells, Inner Tubes, Bushings	
DEL.	Control Arm Lower-Inner Rear Kit Standard replacement	MPU-2085K	1	Outer Shells, Inner Tubes, Bushings	
DEL.	Steering Rack & Pinion Mount Bushing Fits 8/2003 - 11/2005	MPU-3566K	1	Bushings, Inner Tubes, Washers, Inst Sheet	

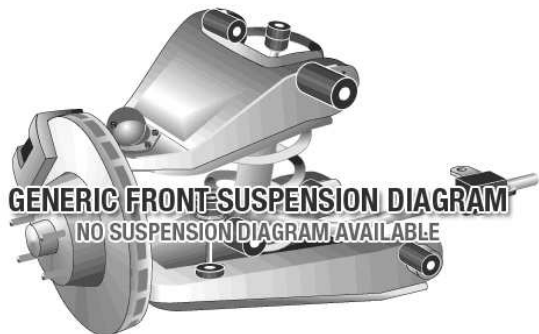

TOYOTA Rav 4 XA30 Series - 5/2005 - 2012

Página 1









Aplicaci...	Descripción	Referencia	Kits por...	Contenido del Kit	
DEL.	Control Arm Lower-Inner Rear Eccentric DOUBLE OFFSET KIT	<b>MPU-3867K</b>	1	Outer Shells, Inner Tubes, Bushings	
DEL.	Control Arm Lower-Inner Rear Eccentric SINGLE OFFSET KIT	<b>MPU-3866K</b>	1	Outer Shells, Inner Tubes, Bushings	
DEL.	Sway Bar Mount To Chassis Bushing Available sizes - 22.2, 23.4,24,25.4mm	<b>MPU-3719-__K</b>	1	Bushings	
TRAS.	Control Arm Upper-Outer Bushing	<b>MPU-4118K</b>	1	Inner Tubes, Bushings	

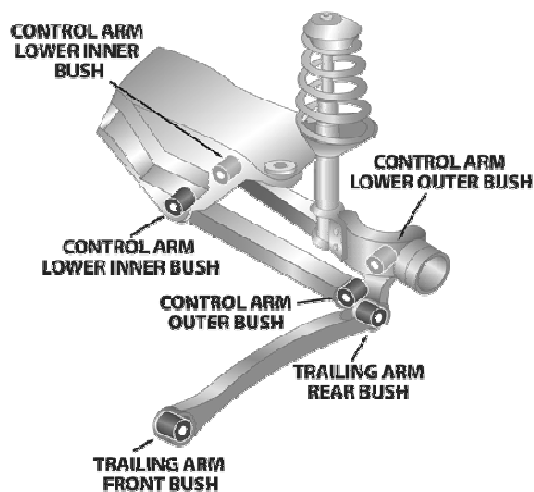
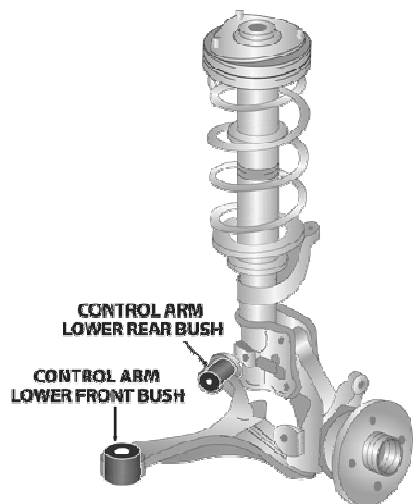

TOYOTA Starlet EP91 EP91 - 3/1996 - 9/1999

Página 1









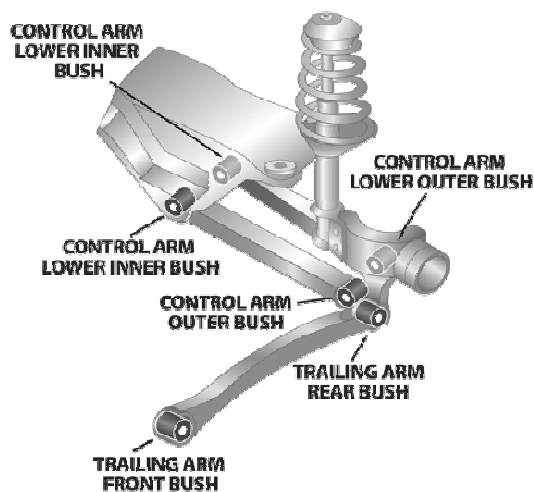
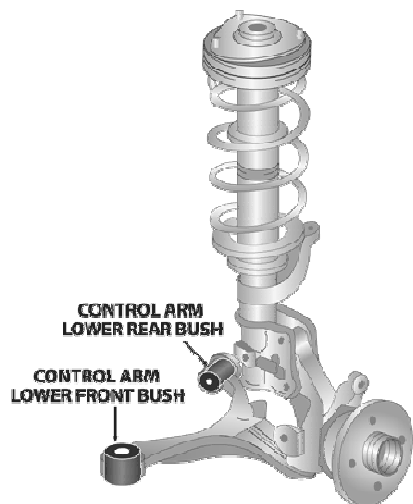

Aplicaci...	Descripción	Referencia	Kits por...	Contenido del Kit	
DEL.	Control Arm Lower-Inner Front Kit Must measure, 34mm OD bush	<b>MPU-1888K</b>	1	Bushings, Inner Tubes	
DEL.	Control Arm Lower-Inner Front Kit Must measure, 31mm OD bush	<b>MPU-1905K</b>	1	Bushings, Inner Tubes	
DEL.	Control Arm Lower-Inner Rear Kit Suits 335mm long mounting bracket,OE # 48652-46010, Do not remove original tube from arm	<b>MPU-2635K</b>	1	Bushings	
DEL.	Control Arm Lower-Inner Rear Kit Suits 50mm short mounting bracket,OE # 48652-10020, Do not remove original tube from arm	<b>MPU-1906K</b>	1	Bushings	
DEL.	Sway Bar Mount Bushing Measure bar diameter 15,16,17,18,19,20,21,22,23,24,25,27mm...	<b>MPU-1487-__K</b>	1	Bushings	



TOYOTA Avalon Sedan - 7/2000 - 6/2005

Página 1



Aplicaci...	Descripción	Referencia	Kits por...	Contenido del Kit	
DEL.	Control Arm Lower Rear Bushing Standard	<b>MPU-1265K</b>	1	Inner Tubes, Bushings	
DEL.	Control Arm Lower-Front Bushing Re-use original mounting pin	<b>MPU-2663K</b>	1	Bushings	
DEL.	Control Arm Lower-Inner Rear Eccentric Cast Arm, PS increased DS standard alignment settings	<b>MPU-1266K</b>	1	Inner Tubes, Bushings	
DEL.	Control Arm Lower-Inner Rear Eccentric Cast Arm, PS increased DS decrease alignment settings	<b>MPU-1267K</b>	1	Inner Tubes, Bushings	
DEL.	Control Arm Lower-Inner Rear Eccentric Pressed Steel Arm, 1 x Standard & 1 x Offset bushing, replaces OE# 4865-06060	<b>MPU-3174K</b>	1	Outer Shells, Inner Tubes, Bushings	
DEL.	Control Arm Lower-Inner Rear Eccentric Pressed Steel Arm, 2 x Offset bushing, replaces OE# 4865-06060	<b>MPU-3175K</b>	1	Outer Shells, Inner Tubes, Bushings	
DEL.	Control Arm Lower-Inner Rear Kit Pressed Steel Arm, Standard replacement OE# 4865-06060	<b>MPU-3173K</b>	1	Outer Shells, Inner Tubes, Bushings	





TOYOTA Avalon Sedan - 7/2000 - 6/2005

Página 2 (Continúa)

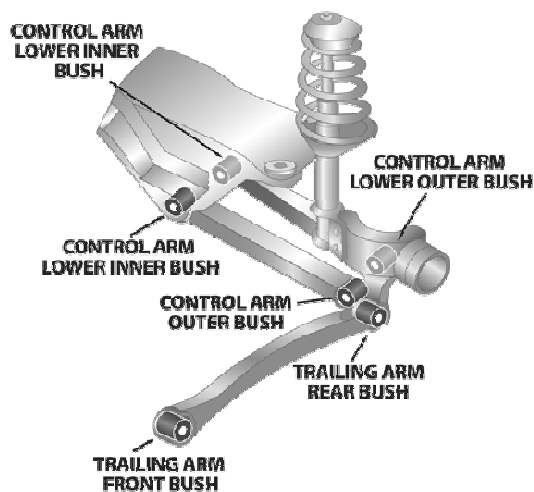
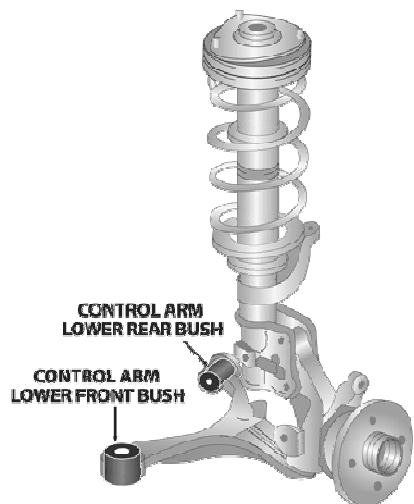







Aplicaci...	Descripción	Referencia	Kits por...	Contenido del Kit	
DEL.	Engine Steady Bushing Large end has 50mm inside diameter	<b>MPU-1348K</b>	1	Bushings, Inner Tubes	
DEL.	Engine Steady Bushing Large end has 65mm inside diameter	<b>MPU-2706K</b>	1	Bushings, Inner Tubes	
DEL.	Steering Rack & Pinion Mount Bushing Koyo Brand rack only	<b>MPU-3197K</b>	1	Inner Tubes, Bushings	
DEL.	Sway Bar Mount Bushing Measure bar diameter, 17mm available. Replaces original part number 48815-06070 = 17mm	<b>MPU-2880-__K</b>	1	Bushings	
TRAS.	Sway Bar Mount To Chassis Bushing Measure bar diameter 15, 16, 17 & 20mm available	<b>MPU-2284-__K</b>	1	Bushings	
TRAS.	Trailing Arm - Bushing Kit	<b>MPU-0823K</b>	1	Inner Tubes, Bushings	

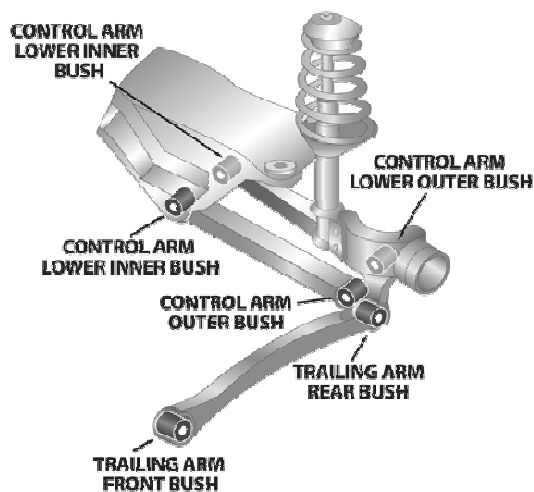
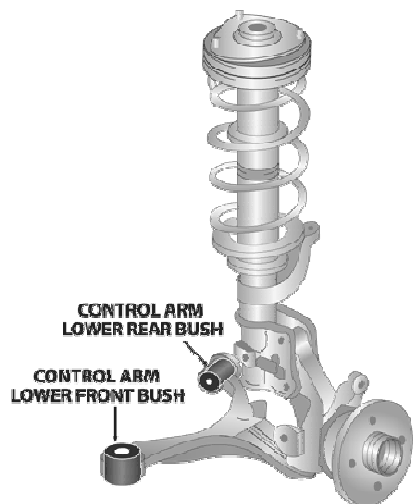

TOYOTA Starlet EP82, EP85 EP82, EP85 - 12/1989 - 1/1996

Página 1









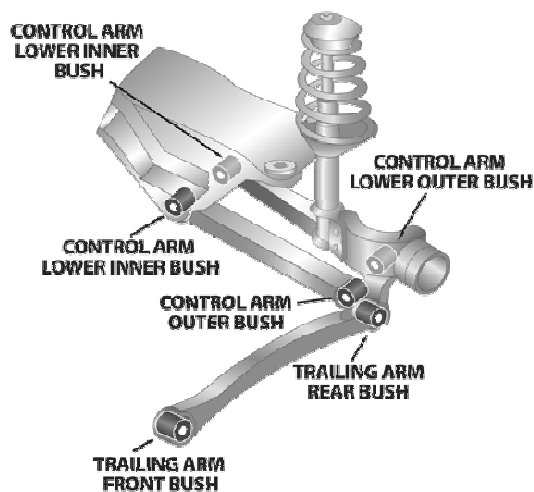
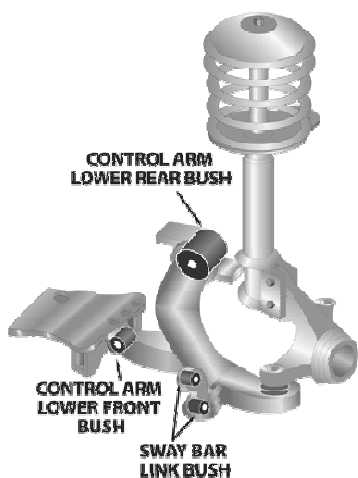

Aplicaci...	Descripción	Referencia	Kits por...	Contenido del Kit	
DEL.	Control Arm Lower-Inner Front Kit Must measure, 34mm OD bush	<b>MPU-1888K</b>	1	Bushings, Inner Tubes	
DEL.	Control Arm Lower-Inner Front Kit Must measure, 31mm OD bush	<b>MPU-1905K</b>	1	Bushings, Inner Tubes	
DEL.	Control Arm Lower-Inner Rear Kit Suits 335mm long mounting bracket,OE # 48652-46010, Do not remove original tube from arm	<b>MPU-2635K</b>	1	Bushings	
DEL.	Control Arm Lower-Inner Rear Kit Suits 50mm short mounting bracket,OE # 48652-10020, Do not remove original tube from arm	<b>MPU-1906K</b>	1	Bushings	
DEL.	Sway Bar Mount To Chassis Bushing Measure bar diameter 15,16,17,18,19,20,21,22,23,24,25,27mm...	<b>MPU-1487-__K</b>	1	Bushings	



## TOYOTA Chaser / Cresta JZX100 - 1996 - 2002

Página 1





Aplicaci...	Descripción	Referencia	Kits por...	Contenido del Kit	
DEL.	Control Arm Lower Rear Bushing Standard replacement	<b>MPU-3040K</b>	1	Outer Shells, Inner Tubes, Bushings	
DEL.	Control Arm Lower Rear Bushing (Eccentric) 1 x standard & 1 x offset bushing; Castor adjustment.	<b>MPU-3041K</b>	1	Outer Shells, Inner Tubes, Bushings	
DEL.	Control Arm Lower Rear Bushing (Eccentric) 2 x offset bushings for castor adjustment.	<b>MPU-3042K</b>	1	Outer Shells, Inner Tubes, Bushings	
DEL.	Motor / Transmission Mount Insert Kit To suit original mount # 12371-46170	<b>MPU-2475K</b>	0	Bushings	
DEL.	Steering Rack & Pinion Mount Bushing	<b>MPU-2699K</b>	1	Bushings, Inner Tubes	
TRAS.	Cross-member Supplement Washers Rear mount, to be fitted into original bushing	<b>MPU-2520K</b>	1	Washers, Bushings	
TRAS.	Cross-member Supplement Washers Front mount	<b>MPU-2553K</b>	1	Bushings	

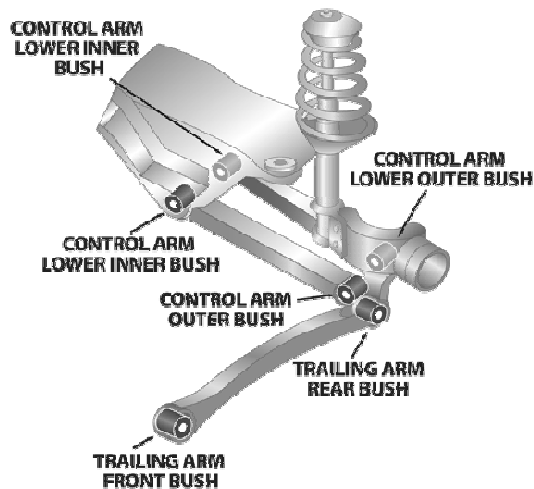
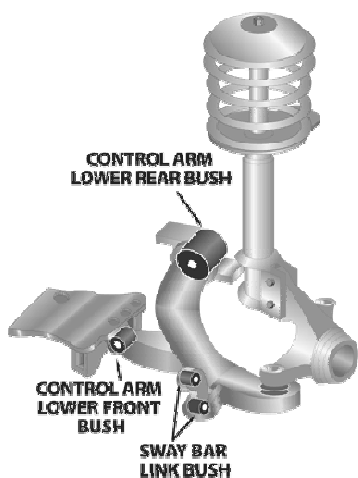

**TOYOTA Chaser / Cresta JZX100 - 1996 - 2002**

Página 2 (Continúa)



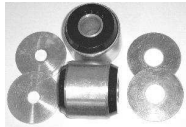

Aplicaci...	Descripción	Referencia	Kits por...	Contenido del Kit	
TRAS.	Sub Frame Rear Bushing Replaces original bushing	<b>MPU-3269K</b>	1	Washers, Outer Shells, Inner Tubes, Bushings	

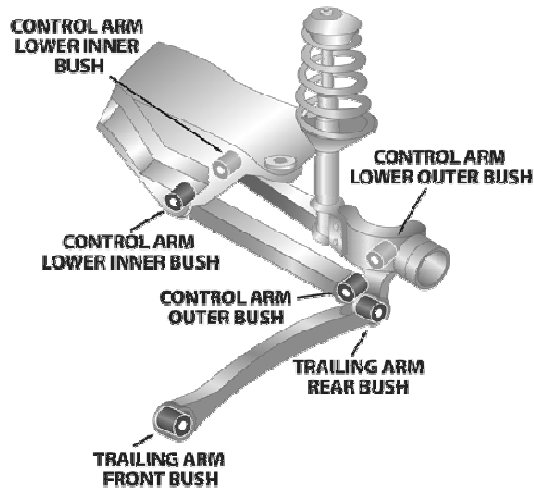
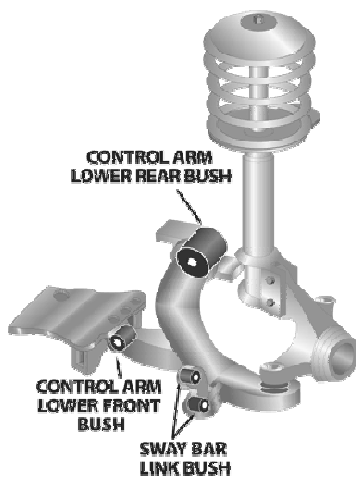

**TOYOTA Chaser / Cresta Mk 2 JZX110 -**

Página 1





Aplicaci...	Descripción	Referencia	Kits por...	Contenido del Kit	
TRAS.	Sway Bar Mount Bushing Replaces OE# 48818-30010 = 14mm. Please measure bar diameter on vehicle as 15,17,18 & 19mm also available.	<b>MPU-2817-__K</b>	1	Bushings	

**TOYOTA Chaser / Cresta GX51Y, GX61Y, MX51Y, MX61Y -...**

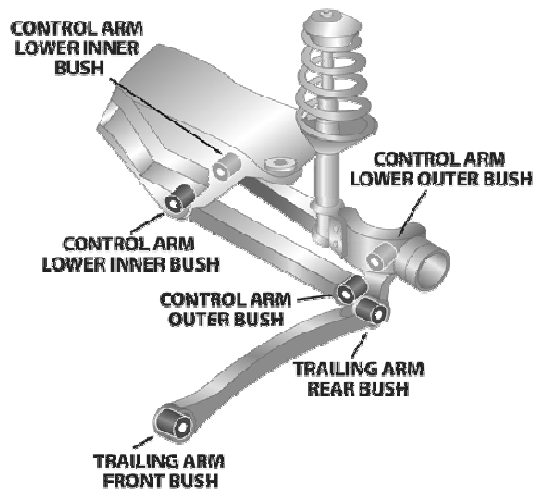
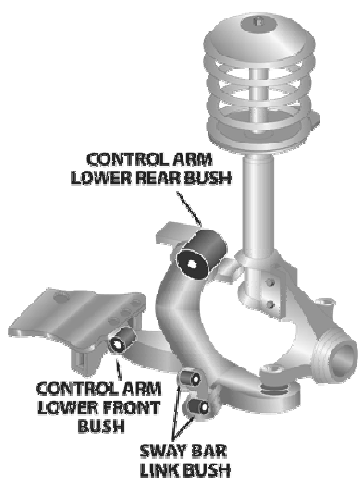
Página 1









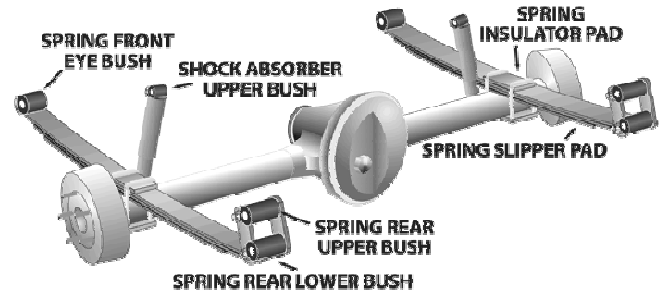
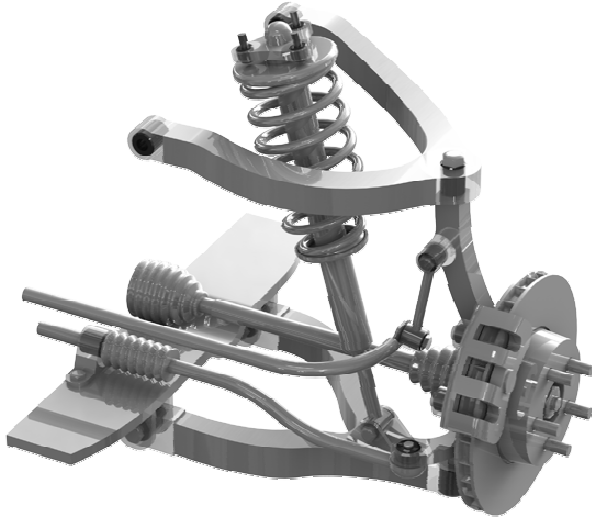

Aplicaci...	Descripción	Referencia	Kits por...	Contenido del Kit	
TRAS.	Control Arm Lower-Inner & Outer Kit Remove OE shell for fitment, 70mm long tubes inner & 65mm tubes outer	<b>MPU-3180K</b>	1	Inner Tubes, Bushings	



## TOYOTA Hilux Vigo 4WD Coil Front & Leaf Rear Vigo,...

Página 1



Aplicaci...	Descripción	Referencia	Kits por...	Contenido del Kit	
DEL.	Control Arm Lower-Inner Front & Rear CONTENTS - SPF2835K x 1, SPF3145K x 1 STANDARD	<b>MPK-181K</b>	1	Bushings, Outer Shells, Inner Tubes, Washers	
DEL.	Control Arm Lower-Inner Front Kit Standard replacement	<b>MPU-3145K</b>	1	Inst Sheet, Washers, Outer Shells, Inner Tubes, Bushings	
DEL.	Control Arm Lower-Inner Front.....Eccentric 2 x Offset, aprox 0.6 degree camber change	<b>MPU-3146K</b>	1	Inst Sheet, Washers, Outer Shells, Inner Tubes, Bushings	
DEL.	Control Arm Lower-Inner Rear Eccentric 2 x Offset bushings, aprox 0.6 degree camber change.	<b>MPU-3147K</b>	1	Inst Sheet, Washers, Outer Shells, Inner Tubes, Bushings	
DEL.	Control Arm Lower-Inner Rear Kit Standard replacement	<b>MPU-2835K</b>	1	Washers, Outer Shells, Inner Tubes, Bushings	
DEL.	Control Arm Upper-Inner Eccentric Kit Offset tube in kit for Camber Decrease on raised vehicles, Remove original shell for fitment	<b>MPU-3230K</b>	1	Inst Sheet, Washers, Inner Tubes, Bushings	 SPF3230K
DEL.	Control Arm Upper-Inner Kit Standard replacement, Remove original shell for fitment	<b>MPU-2845K</b>	1	Washers, Inner Tubes, Bushings	



## TOYOTA Hilux Vigo 4WD Coil Front & Leaf Rear Vigo,...

Página 2 (Continúa)

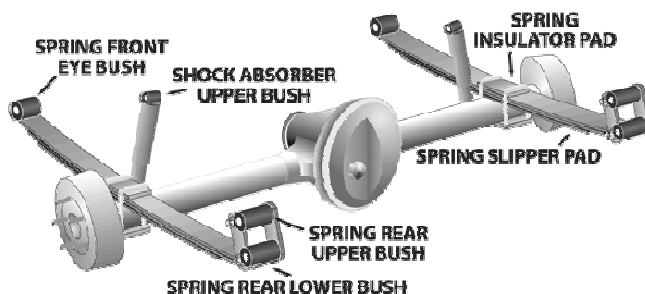
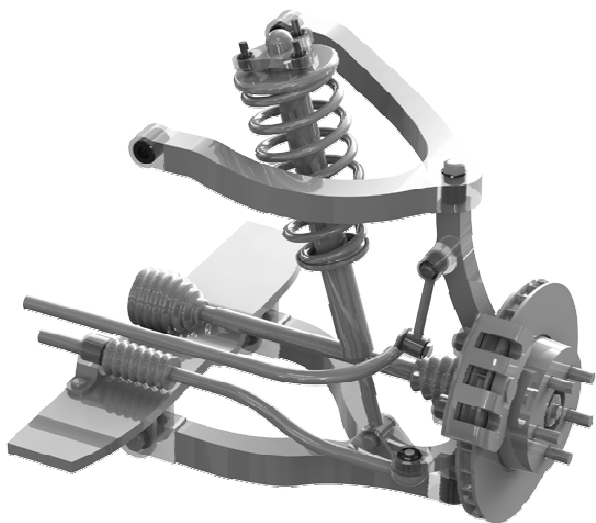

Aplicaci...	Descripción	Referencia	Kits por...	Contenido del Kit	
DEL.	Shock Absorber Lower Bushing	<b>MPU-3591K</b>	1	Outer Shells, Inner Tubes, Bushings	
DEL.	Shock Absorber Upper Bushing	<b>MPU-2833K</b>	1	Bushings	
DEL.	Steering Rack & Pinion Mount Bush.....Power Steering	<b>MPU-3144K</b>	1	Washers, Inner Tubes, Bushings	
DEL.	Sway Bar Mount Bushing Measure bar diameter 28, 30mm & 31 available	<b>MPU-2813-__K</b>	1	Bushings	
TRAS.	Leaf Spring Bushing All	<b>MPK-096K</b>	1	Bushings, Inner Tubes	
TRAS.	Spring Front Eye Bushing 40mm spring eye inside diameter	<b>MPU-2670K</b>	1	Inner Tubes, Bushings	
TRAS.	Spring Rear Eye Bushing	<b>MPU-2671K</b>	1	Bushings	





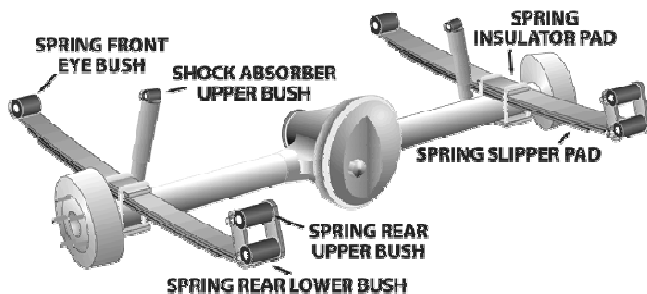
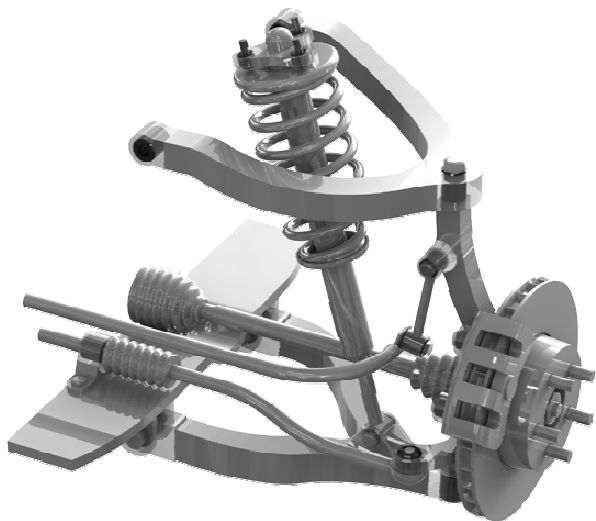

**TOYOTA Hilux Vigo 4WD Coil Front & Leaf Rear Vigo,...**

Página 3 (Continúa)



Aplicaci...	Descripción	Referencia	Kits por...	Contenido del Kit	
TRAS.	Spring Shackle Upper Bushing	MPU-2672K	1	Bushings	



TOYOTA Caldina ST190,AT211, ST210, ST190 - 11/1992 - 2000

Página 1

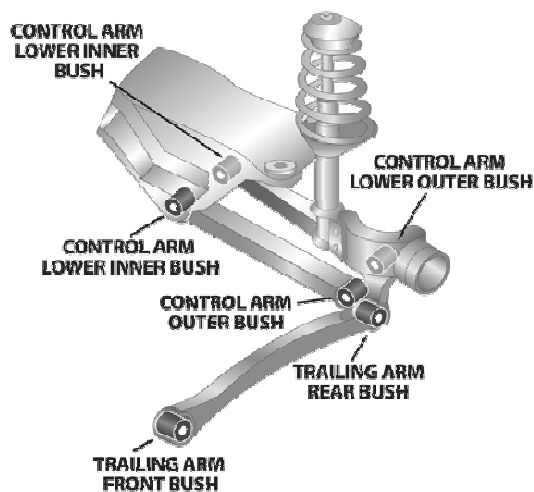
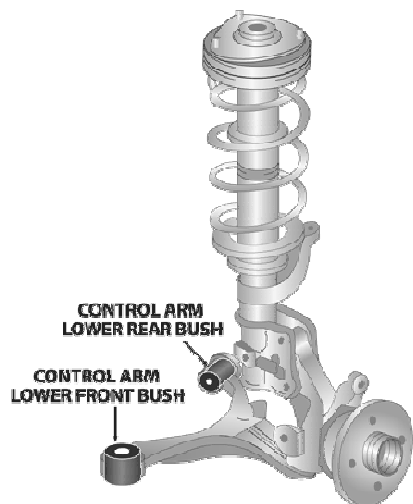







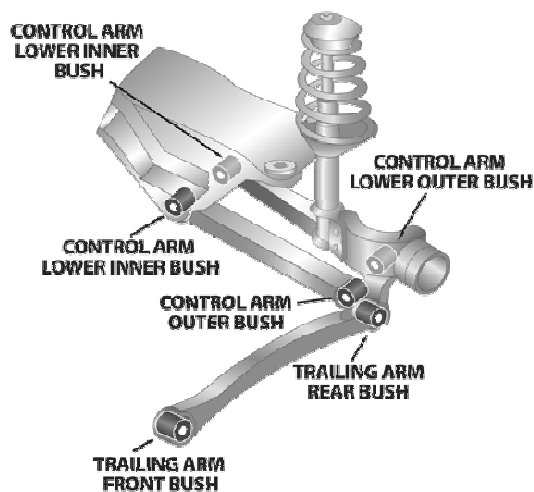
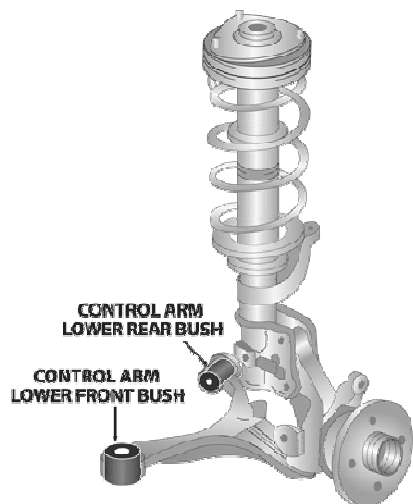

Aplicaci...	Descripción	Referencia	Kits por...	Contenido del Kit	
DEL.	Control Arm Lower-Inner Front Kit	<b>MPU-1346K</b>	1	Inner Tubes, Bushings	
DEL.	Control Arm Lower-Inner Rear Kit Vertical pivoting bush	<b>MPU-2742K</b>	1	Outer Shells, Inner Tubes, Bushings	
TRAS.	Sway Bar Mount Bushing Measure sway bar diameter	<b>MPU-2790-__K</b>	1	Bushings	



TOYOTA Echo / Yaris 1st Generation NCP12 - 10/1999 - 2006

Página 1





Aplicaci...	Descripción	Referencia	Kits por...	Contenido del Kit	
DEL.	Control Arm Lower-Inner Front Kit Bushing to suit RH OE# 48068-59035 arm & LH OE# 48069-59035 arm, 12mm mounting bolt.	<b>MPU-2781K</b>	1	Inner Tubes, Bushings	 SPF2781K
DEL.	Control Arm Lower-Inner Rear Eccentric Performance Settings, 2 x offset bushings for castor adjustment	<b>MPU-2798K</b>	1	Outer Shells, Inner Tubes, Bushings	
DEL.	Control Arm Lower-Inner Rear Eccentric Alignment adjustment, 1 x offset & 1 x standard bushings for castor adjustment	<b>MPU-2797K</b>	1	Outer Shells, Inner Tubes, Bushings	
DEL.	Control Arm Lower-Inner Rear Kit Remove original shell for fitment, Replaces bushings in complete original assy RH = 48068-59035 LH...	<b>MPU-2782K</b>	1	Outer Shells, Inner Tubes, Bushings	
DEL.	Engine Mount Left Void Filler Insert into original rubber part 12372-0M040	<b>MPU-3215K</b>	1	Bushings	
DEL.	Engine Mount Rear Void Filler Insert into original rubber part 12371-0M030	<b>MPU-3216K</b>	1	Bushings	
DEL.	Engine Mount Right Void Filler	<b>MPU-3217K</b>	1	Bushings	

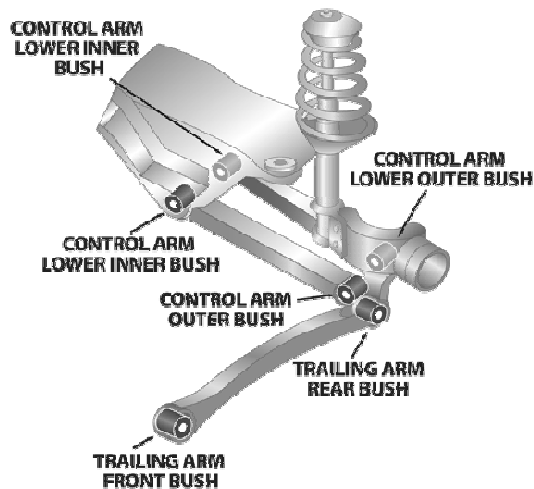
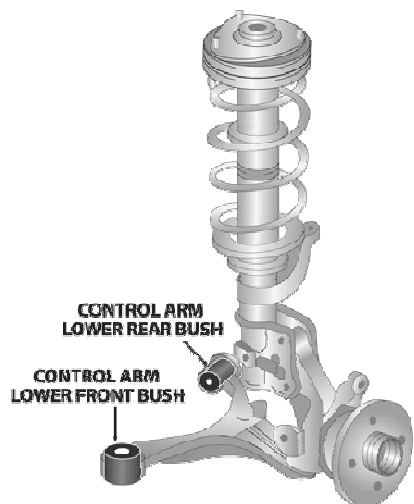

**TOYOTA Echo / Yaris 1st Generation NCP12 - 10/1999 - 2006**

Página 2 (Continúa)



Aplicaci...	Descripción	Referencia	Kits por...	Contenido del Kit	
DEL.	Sway Bar Mount Bushing Measure sway bar diameter, 25mm available. Replaces original part number 48815-52030	<b>MPU-2959-__K</b>	1	Bushings	



TOYOTA Kluger ACU25, MCU25,MCU28 - 11/2000 - 2007

Página 1

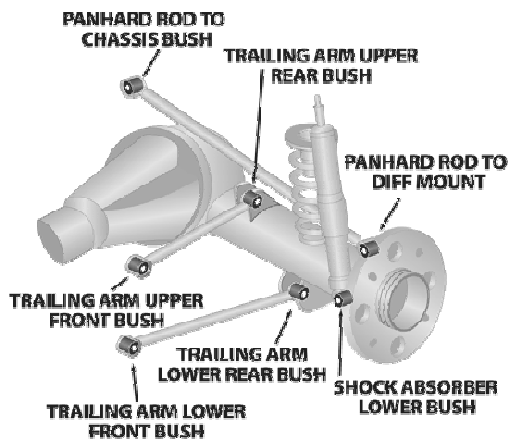
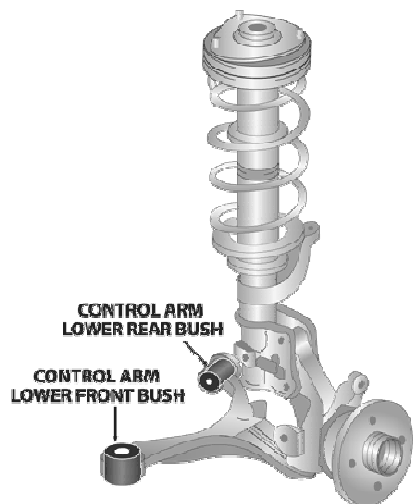







Aplicaci...	Descripción	Referencia	Kits por...	Contenido del Kit	
DEL.	Control Arm Lower-Inner Rear Eccentric 1 x Standard bushing & 1 x Offset bushing kit	<b>MPU-2903K</b>	1	Outer Shells, Inner Tubes, Bushings	
DEL.	Control Arm Lower-Inner Rear Eccentric 2 x Offset bushing kit, Recomendado for vehicles with pull left issues	<b>MPU-2904K</b>	1	Outer Shells, Inner Tubes, Bushings	
DEL.	Control Arm Lower-Inner Rear Kit Standard replacement kit	<b>MPU-2902K</b>	1	Outer Shells, Inner Tubes, Bushings	
DEL.	Sway Bar Mount Bushing Measure bar diameter	<b>MPU-1319-__K</b>	1	Bushings	
TRAS.	Sway Bar Mount Bushing Measure bar diameter, 14mm available	<b>MPU-2790-__K</b>	1	Bushings	

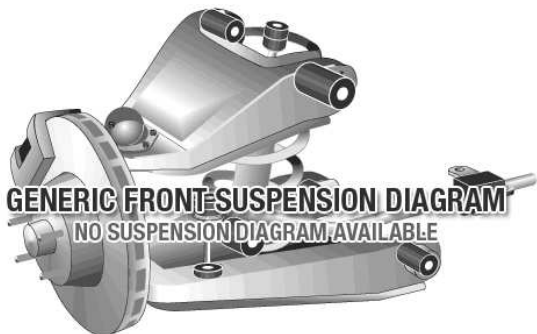

## TOYOTA Kluger GSU40R, GSU45R - 8/2007 - Current

Página 1





Aplicaci...	Descripción	Referencia	Kits por...	Contenido del Kit	
DEL.	Control Arm Lower-Inner Rear Eccentric 1 x Standard bushing 1 x Offset bushing	<b>MPU-2903K</b>	1	Outer Shells, Inner Tubes, Bushings	
DEL.	Control Arm Lower-Inner Rear Eccentric 2 x Offset bushing kit, Recomendado for vehicles with pull left issues	<b>MPU-2904K</b>	1	Outer Shells, Inner Tubes, Bushings	
DEL.	Control Arm Lower-Inner Rear Kit Standard replacement kit	<b>MPU-2902K</b>	1	Outer Shells, Inner Tubes, Bushings	
TRAS.	Trailing Arm - Lower Bushing	<b>MPU-0823K</b>	1	Inner Tubes, Bushings	

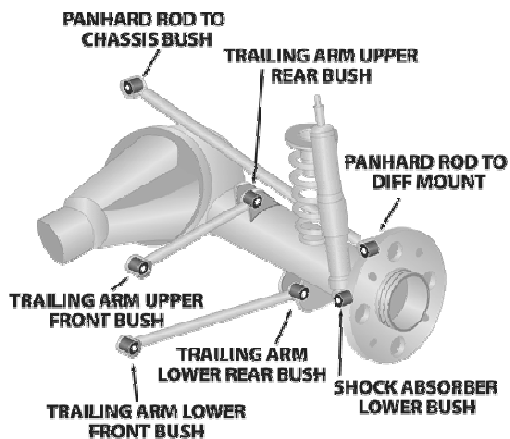
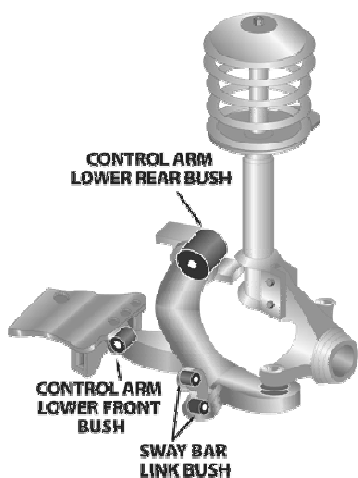

**TOYOTA Harrier ACU15, MCU15, SXU15 -**









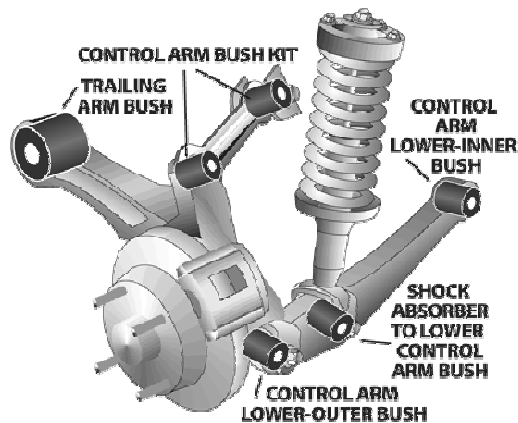
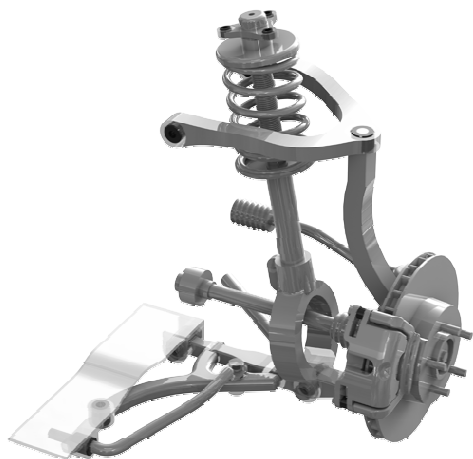

Aplicaci...	Descripción	Referencia	Kits por...	Contenido del Kit	
TRAS.	Sway Bar Mount Bushing Measure sway bar diameter, 14mm available	MPU-2790-__K	1	Bushings	



## TOYOTA Altezza Gita, GXE10,SXE10 - 1999 - 2005

Página 1



Aplicaci...	Descripción	Referencia	Kits por...	Contenido del Kit	
DEL.	Control Arm Lower Rear Bushing Standard replacement	<b>MPU-3040K</b>	1	Outer Shells, Inner Tubes, Bushings	
DEL.	Control Arm Lower Rear Bushing (Eccentric) 1 x standard & 1 x offset bushing; Castor adjustment.	<b>MPU-3041K</b>	1	Outer Shells, Inner Tubes, Bushings	
DEL.	Control Arm Lower Rear Bushing (Eccentric) 2 x offset bushings for castor adjustment.	<b>MPU-3042K</b>	1	Outer Shells, Inner Tubes, Bushings	
DEL.	Control Arm Lower-Inner Bushing	<b>MPU-3039K</b>	1	Inner Tubes, Bushings	
DEL.	Sway Bar Mount Bushing Replaces OE# 48815-53010 = 27mm; Measure bar diameter	<b>MPU-2816-__K</b>	1	Bushings	
TRAS.	Control Arm Lower-Inner Bushing Standard replacement	<b>MPU-3036K</b>	1	Outer Shells, Inner Tubes, Bushings	
TRAS.	Control Arm Lower-Inner Eccentric Kit Camber +/- adjustment both sides, approximately 0.6 degree camber change	<b>MPU-3037K</b>	1	Outer Shells, Inner Tubes, Bushings	









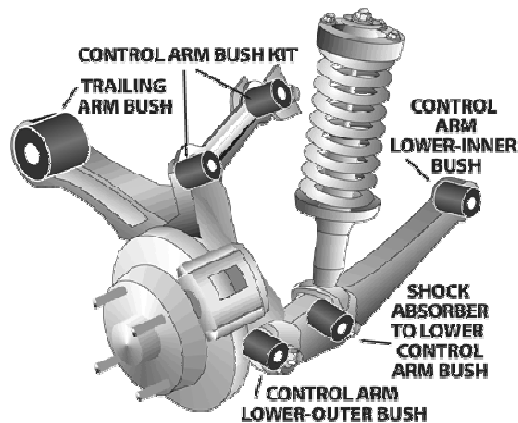
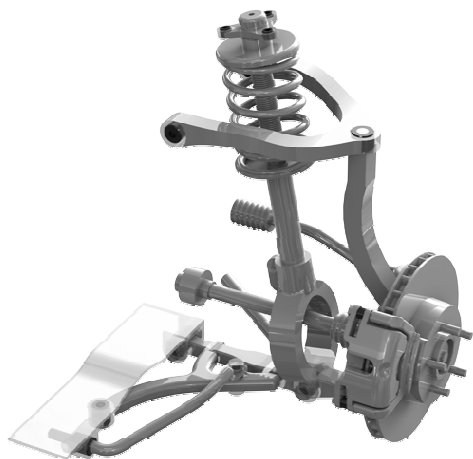

## TOYOTA Altezza Gita, GXE10,SXE10 - 1999 - 2005

Página 2 (Continúa)





Aplicaci...	Descripción	Referencia	Kits por...	Contenido del Kit	
TRAS.	Control Arm Upper-Inner Eccentric Kit Camber adjustment +/- both sides, approximately 0.6 degree camber change	<b>MPU-3044K</b>	1	Inner Tubes, Bushings	
TRAS.	Control Arm Upper-Inner Kit Standard replacement	<b>MPU-3043K</b>	1	Inner Tubes, Bushings	
TRAS.	Sway Bar Mount Bushing Replaces OE# 48818-30010 = 14mm. Please measure bar diameter on vehicle as 15,17,18 & 19mm also available.	<b>MPU-2817-__K</b>	1	Bushings	
TRAS.	Toe Control Arm - Inner Bushing Note	<b>MPU-2786K</b>	1	Inner Tubes, Bushings	
TRAS.	Trailing Arm - Front Bushing	<b>MPU-2784K</b>	1	Inner Tubes, Bushings	
TRAS.	Trailing Arm - Rear Bushing Bushing located in hub	<b>MPU-2785K</b>	1	Inner Tubes, Bushings	

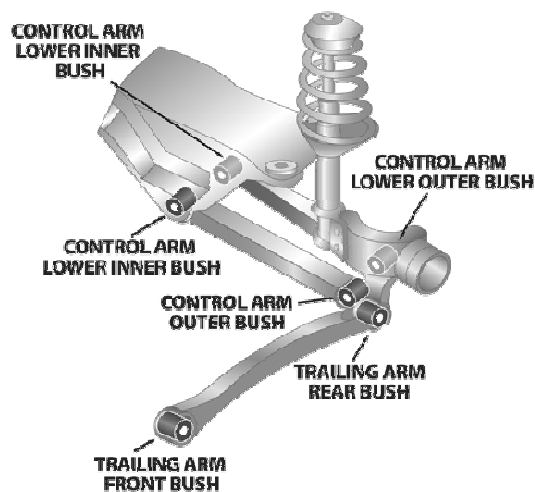
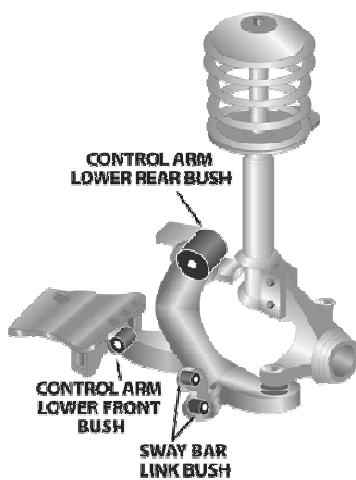

**TOYOTA Brevis JCG10 / 11 -**

Página 1





Aplicaci...	Descripción	Referencia	Kits por...	Contenido del Kit	
DEL.	Sway Bar Mount Bushing Replaces OE# 48815-53010 = 27mm; Measure bar diameter	<b>MPU-2816-__K</b>	1	Bushings	

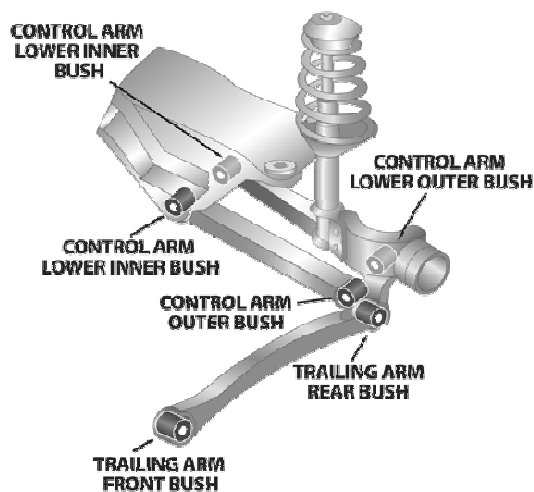
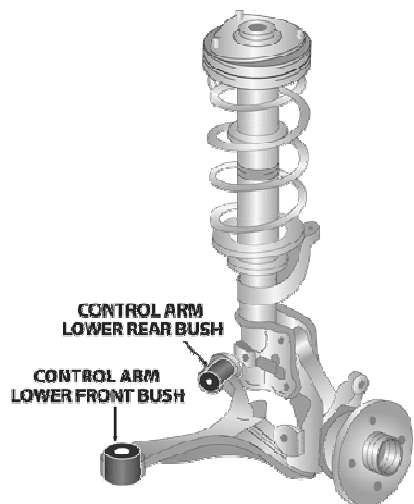

**TOYOTA Progres JCG10, 11 -**

Página 1



Aplicaci...	Descripción	Referencia	Kits por...	Contenido del Kit	
TRAS.	Sway Bar Mount Bushing Replaces OE# 48818-30010 = 14mm. Please measure bar diameter on vehicle as 15,17,18 & 19mm also available.	<b>MPU-2817-__K</b>	1	Bushings	



**TOYOTA Aristo JZS160 -**

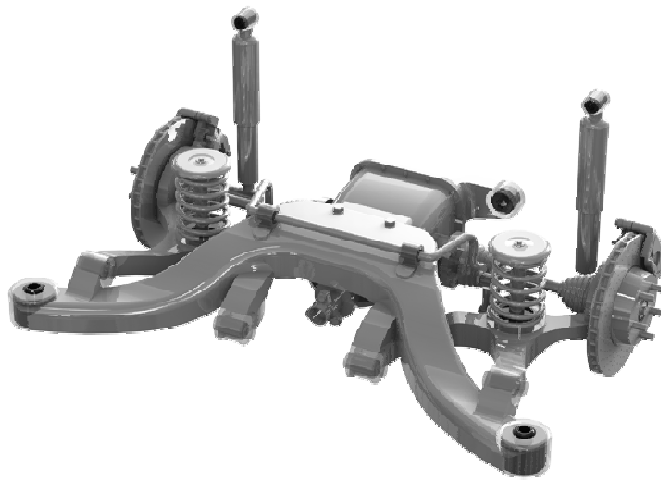
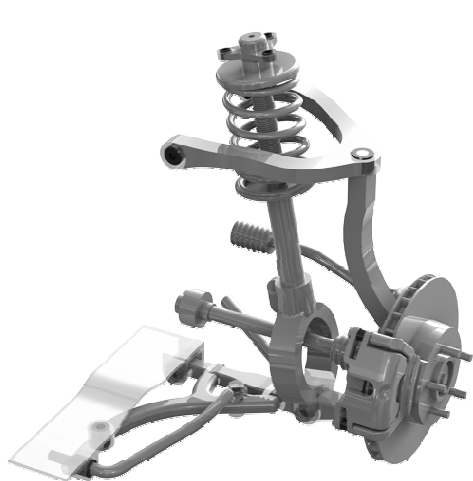







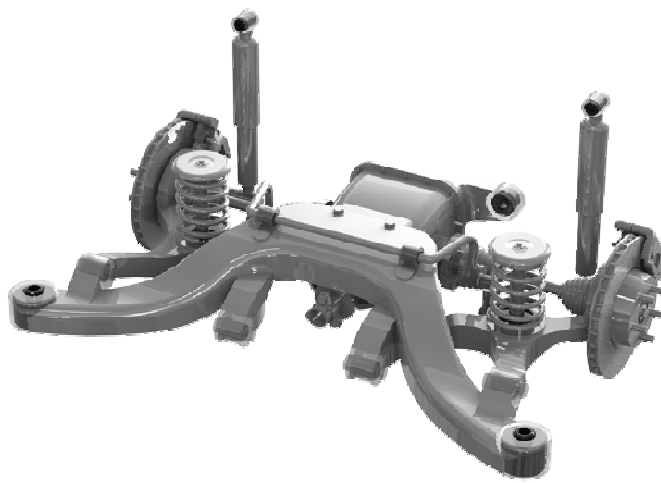
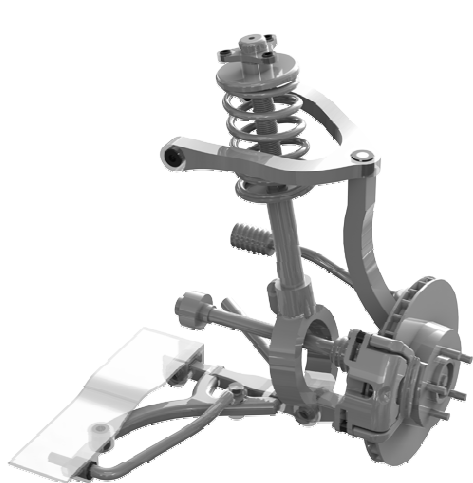

Aplicaci...	Descripción	Referencia	Kits por...	Contenido del Kit	
DEL.	Steering Rack & Pinion Mount Bushing Replaces OE#45517-24030,suited to vehicles with steering rack housing outside diameter...	<b>MPU-1193-50K</b>	1	Inner Tubes, Bushings	
DEL.	Steering Rack & Pinion Mount Bushing Replaces OE#45517-14040,suited to vehicles with steering rack housing outside diameter...	<b>MPU-1193-47K</b>	1	Inner Tubes, Bushings	
TRAS.	Sway Bar Mount Bushing Replaces OE# 48818-30010 = 14mm. Please measure bar diameter on vehicle as 15,17,18 & 19mm also available.	<b>MPU-2817-__K</b>	1	Bushings	

## TOYOTA Aristo JZS147 - 1991 - 1996

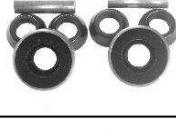
Página 1









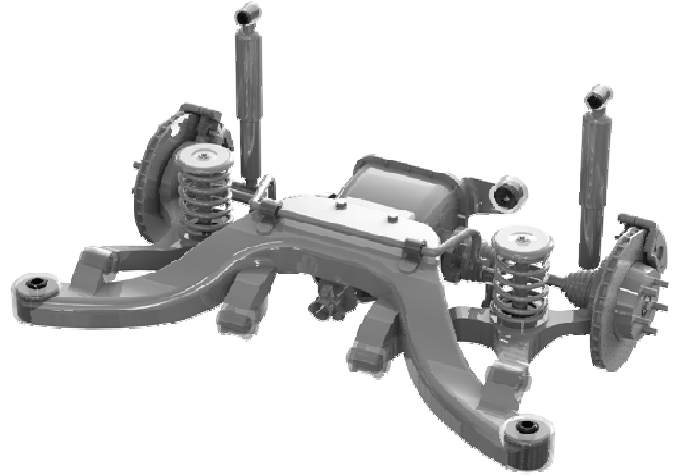
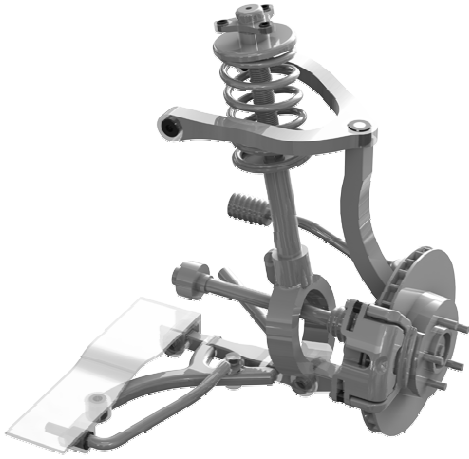

Aplicaci...	Descripción	Referencia	Kits por...	Contenido del Kit	
DEL.	Control Arm Lower-Inner Bushing Standard replacement kit	<b>MPU-3162K</b>	1	Inner Tubes, Bushings	
DEL.	Control Arm Lower-Inner Eccentric Kit Offset tube for Camber adjust +/-	<b>MPU-3163K</b>	1	Inner Tubes, Bushings	
DEL.	Control Arm Upper-Inner Kit Replaces OE# 48632-30090	<b>MPU-3161K</b>	1	Inner Tubes, Bushings	
DEL.	Strut Bar To Chassis Mount Kit Replaces OE# 48655-30020	<b>MPU-3087K</b>	1	Outer Shells, Inner Tubes, Bushings	
DEL.	Strut Bar To Chassis Mount-Adjustable Bushing 1 x Standard & 1 x Offset bushing, Replaces OE#4865-30020	<b>MPU-3088K</b>	1	Outer Shells, Inner Tubes, Bushings	
DEL.	Sway Bar Mount Bushing Replaces OE#48815-90370 @ 30mm; Please measure bar diameter on vehicle	<b>MPU-3164-__K</b>	1	Bushings	
TRAS.	Control Arm Lower-Inner Bushing	<b>MPU-3032K</b>	1	Inner Tubes, Bushings	

## TOYOTA Aristo JZS147 - 1991 - 1996

Página 2 (Continúa)





Aplicaci...	Descripción	Referencia	Kits por...	Contenido del Kit	
TRAS.	Control Arm Lower-Shock Mount Kit	<b>MPU-3033K</b>	1	Inner Tubes, Bushings	
TRAS.	Control Arm Upper-Inner Kit Remove outer shells for fitment	<b>MPU-1922K</b>	1	Inner Tubes, Bushings	
TRAS.	Cross-member Supplement Washers Rear mount, to be fitted into original bushing	<b>MPU-2520K</b>	1	Washers, Bushings	
TRAS.	Differential Pinion Mount Bushing Upper is replacement bushing, lower is insert to original rubber bushing	<b>MPU-2769K</b>	1	Washers, Bushings	
TRAS.	Sub Frame Rear Bushing Replaces original bushing	<b>MPU-3269K</b>	1	Washers, Outer Shells, Inner Tubes, Bushings	
TRAS.	Sway Bar Mount Bushing Replaces OE# 48818-30080 @ 24mm; Please measure bar diameter on vehicle	<b>MPU-3165-__K</b>	1	Bushings	
TRAS.	Toe Control Arm - Inner Bushing Outer end of arm is ball joint style bushing	<b>MPU-3017K</b>	1	Inner Tubes, Bushings	

**TOYOTA Aristo JZS147 - 1991 - 1996**

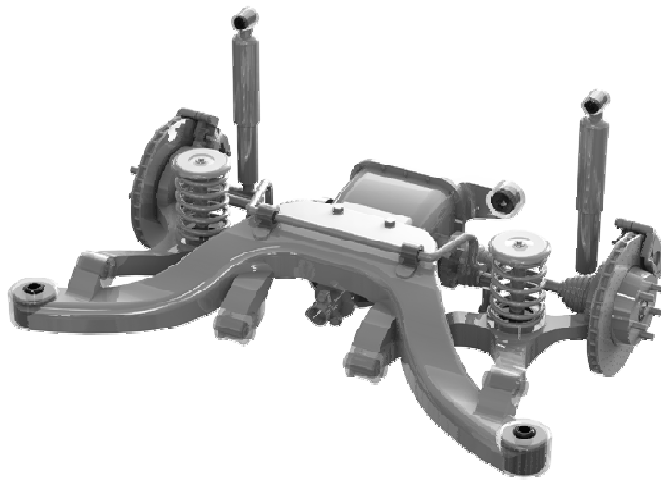
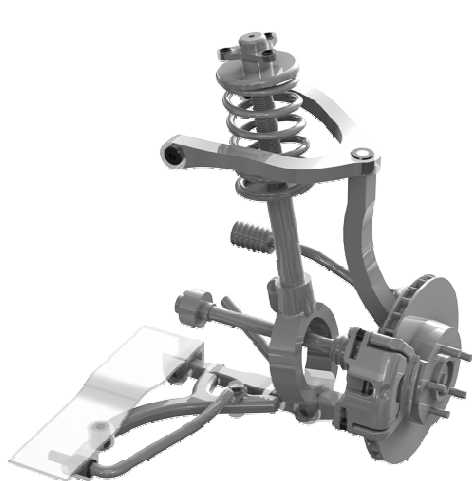
Página 3 (Continúa)









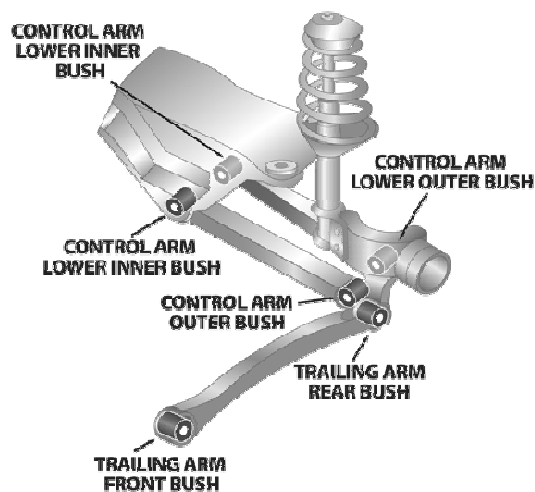
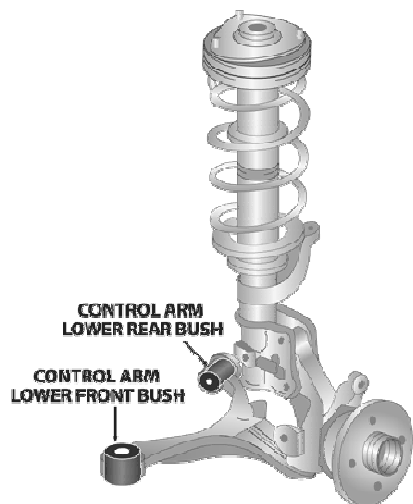

Aplicaci...	Descripción	Referencia	Kits por...	Contenido del Kit	
TRAS.	Trailing Arm - Front Bushing	<b>MPU-3016K</b>	1	Inner Tubes, Bushings	
TRAS.	Trailing Arm - Rear Bushing Bushing located in hub	<b>MPU-3031K</b>	1	Inner Tubes, Bushings	



## TOYOTA Aurion GSV40R - 2006 - 2012

Página 1





Aplicaci...	Descripción	Referencia	Kits por...	Contenido del Kit	
DEL.	Control Arm Lower-Inner Rear Kit Standard replacement kit.	<b>MPU-2902K</b>	1	Outer Shells, Inner Tubes, Bushings	 SPF2902K
DEL.	Control Arm Lower-Inner Rear Kit 1 x Standard bushing & 1 x Offset bushing kit.	<b>MPU-2903K</b>	1	Outer Shells, Inner Tubes, Bushings	
DEL.	Control Arm Lower-Inner Rear Kit 2 x Offset bushing kit; Recomendado for vehicles with pull left issues.	<b>MPU-2904K</b>	1	Outer Shells, Inner Tubes, Bushings	
DEL.	Steering Rack & Pinion Mount Bush.....Power Steering	<b>MPU-3769K</b>	1	Washers, Inner Tubes, Bushings	 SPF3769K
TRAS.	Lateral Arm Front Outer Bushing	<b>MPU-3880K</b>	1	Inner Tubes, Bushings	
TRAS.	Trailing Arm - Lower Bushing	<b>MPU-0823K</b>	1	Inner Tubes, Bushings	 SPF0823K

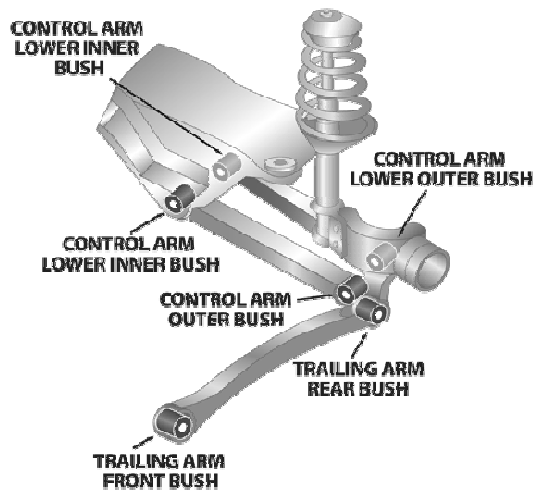
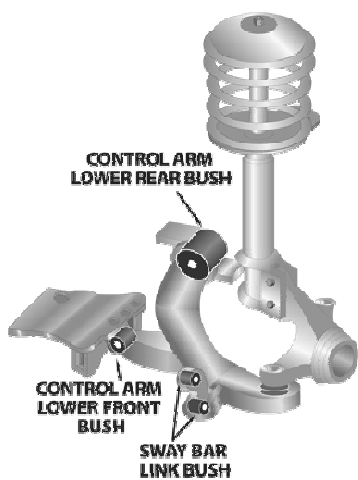

**TOYOTA Mark II RX63X,GX61X,MX61X - 1980 - 1984**

Página 1





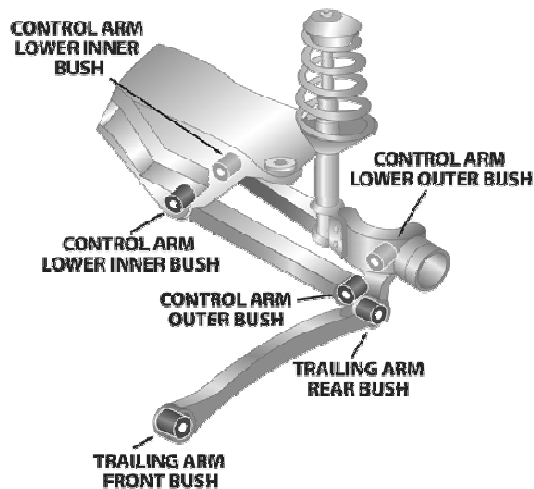
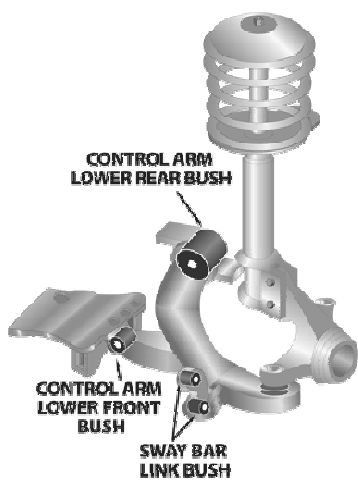

Aplicaci...	Descripción	Referencia	Kits por...	Contenido del Kit	
TRAS.	Control Arm Lower-Inner & Outer Kit Remove OE shell for fitment, 70mm long tubes inner & 65mm tubes outer	<b>MPU-3180K</b>	1	Inner Tubes, Bushings	

## TOYOTA Mark II X90 Series, Generation 7 - 1992 - 1996

Página 1



Aplicaci...	Descripción	Referencia	Kits por...	Contenido del Kit	
DEL.	Control Arm Lower Rear Bushing Standard replacement	<b>MPU-3040K</b>	1	Outer Shells, Inner Tubes, Bushings	
DEL.	Control Arm Lower Rear Bushing (Eccentric) 1 x standard & 1 x offset bushing; Castor adjustment.	<b>MPU-3041K</b>	1	Outer Shells, Inner Tubes, Bushings	
DEL.	Control Arm Lower Rear Bushing (Eccentric) 2 x offset bushings for castor adjustment.	<b>MPU-3042K</b>	1	Outer Shells, Inner Tubes, Bushings	
DEL.	Control Arm Lower-Inner Bushing	<b>MPU-3039K</b>	1	Inner Tubes, Bushings	



## TOYOTA Mark II X100 Series, Generation 8 - 1996 - 2000

Página 1

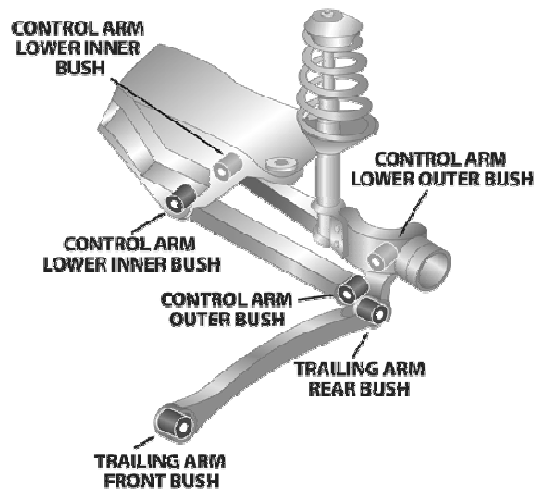
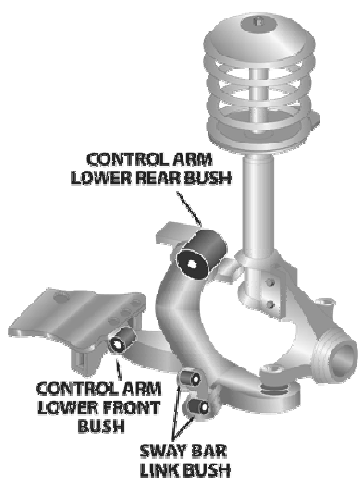



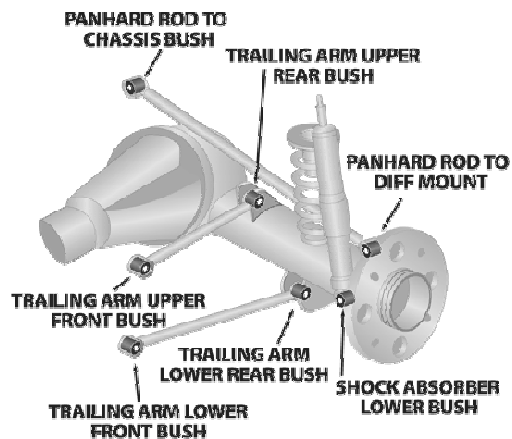
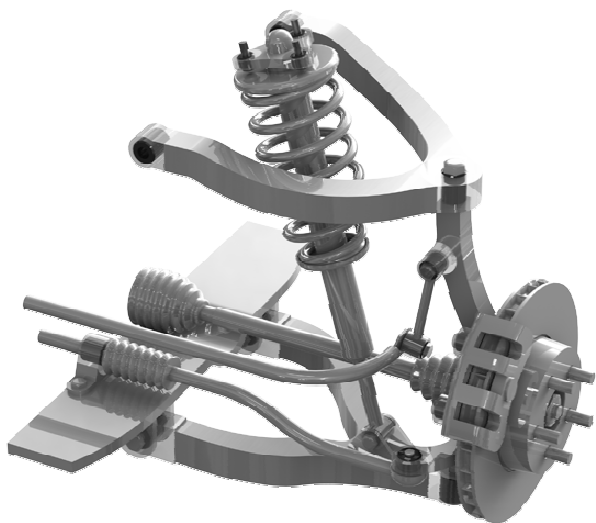

Aplicaci...	Descripción	Referencia	Kits por...	Contenido del Kit	
DEL.	Control Arm Lower Rear Bushing Standard replacement	<b>MPU-3040K</b>	1	Outer Shells, Inner Tubes, Bushings	
DEL.	Control Arm Lower Rear Bushing (Eccentric) 1 x standard & 1 x offset bushing; Castor adjustment.	<b>MPU-3041K</b>	1	Outer Shells, Inner Tubes, Bushings	
DEL.	Control Arm Lower Rear Bushing (Eccentric) 2 x offset bushings for castor adjustment.	<b>MPU-3042K</b>	1	Outer Shells, Inner Tubes, Bushings	

## TOYOTA FJ Cruiser SUV Compact - 2006 - Current

Página 1





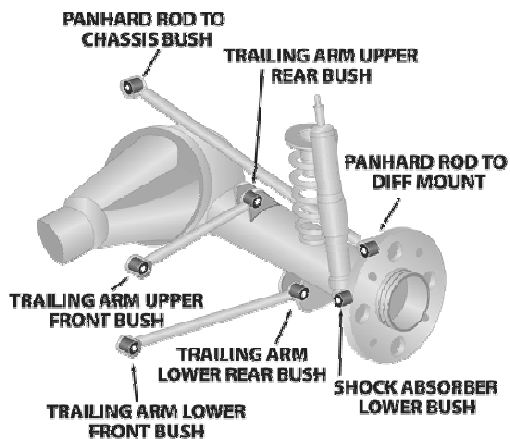
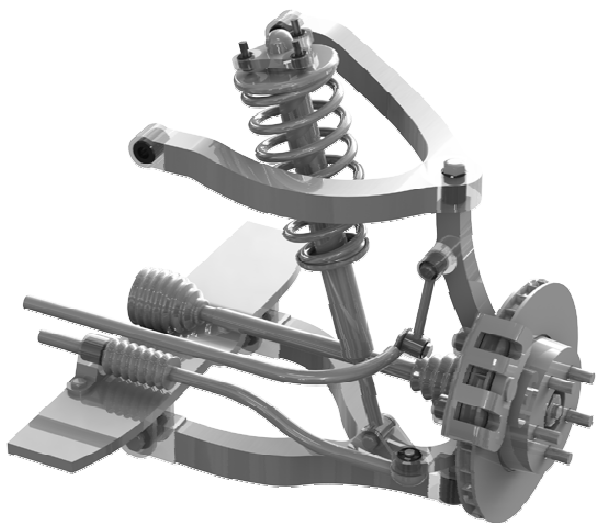

Aplicaci...	Descripción	Referencia	Kits por...	Contenido del Kit	
DEL.	Control Arm Lower-Inner Front & Rear CONTENTS - SPF2834K x 1, SPF2835K x 1	<b>MPK-180K</b>	1	Washers, Outer Shells, Inner Tubes, Bushings	
DEL.	Control Arm Lower-Inner Front Kit Replaces original shell part	<b>MPU-2834K</b>	1	Washers, Outer Shells, Inner Tubes, Bushings	
DEL.	Control Arm Lower-Inner Rear Kit Standard replacement	<b>MPU-2835K</b>	1	Washers, Outer Shells, Inner Tubes, Bushings	
DEL.	Control Arm Upper-Inner Eccentric Kit Offset tube in kit for Camber Decrease on raised vehicles, Remove original shell for fitment	<b>MPU-3230K</b>	1	Inst Sheet, Washers, Inner Tubes, Bushings	 SPF3230K
DEL.	Control Arm Upper-Inner Kit Standard replacement, Remove original shell for fitment	<b>MPU-2845K</b>	1	Washers, Inner Tubes, Bushings	
DEL.	Shock Absorber Lower Bushing	<b>MPU-3591K</b>	1	Outer Shells, Inner Tubes, Bushings	
DEL.	Sway Bar Mount Bushing Measure bar diameter, 19, 29mm available	<b>MPU-2506-__K</b>	1	Bushings	

## TOYOTA FJ Cruiser SUV Compact - 2006 - Current

Página 2 (Continúa)



Aplicaci...	Descripción	Referencia	Kits por...	Contenido del Kit	
TRAS.	Panhard Rod Bushing Replaces both ends of the bar	<b>MPU-2836K</b>	1	Inner Tubes, Bushings	
TRAS.	Sway Bar Mount Bushing Measure bar diameter, 15,16,17,18,19,20,21,22,23,24,25 & 27mm	<b>MPU-1487-__K</b>	1	Bushings	
TRAS.	Trailing Arm Lower Bushing All	<b>MPU-2461K</b>	2	Inner Tubes, Bushings	
TRAS.	Trailing Arm Upper Bushing All Replaces both ends of the bar	<b>MPU-1760K</b>	2	Inner Tubes, Bushings	

## TOYOTA Vios 1st Generation - 2003 - 2007

Página 1

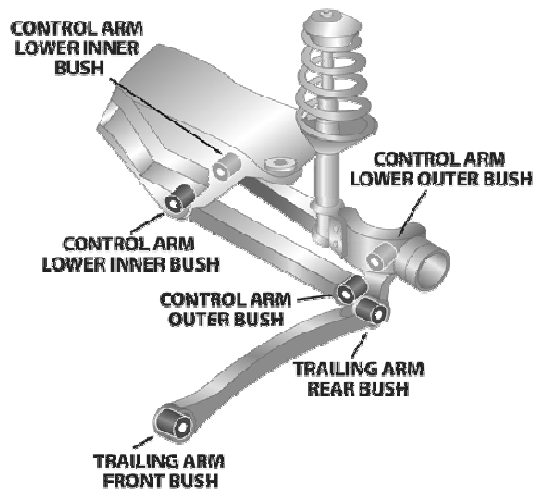
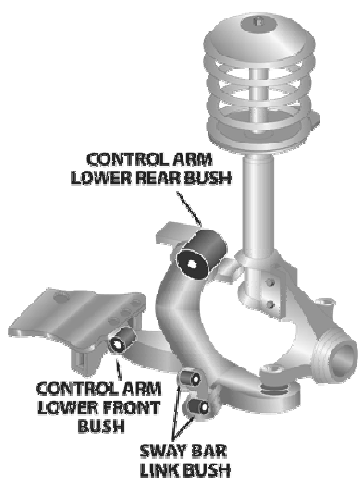

Aplicaci...	Descripción	Referencia	Kits por...	Contenido del Kit	
DEL.	Engine Mount Left Void Filler Insert into original rubber part 12372-0M040	<b>MPU-3215K</b>	1	Bushings	
DEL.	Engine Mount Rear Void Filler Insert into original rubber part 12371-0M030	<b>MPU-3216K</b>	1	Bushings	
DEL.	Engine Mount Right Void Filler	<b>MPU-3217K</b>	1	Bushings	

## TOYOTA Yaris 1st Generation - 1999 - 2005

Página 1

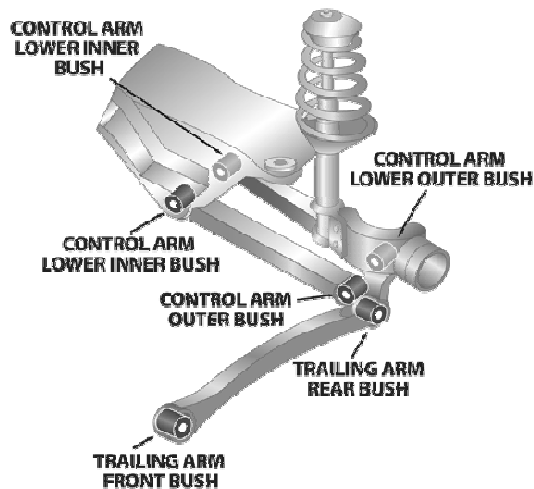
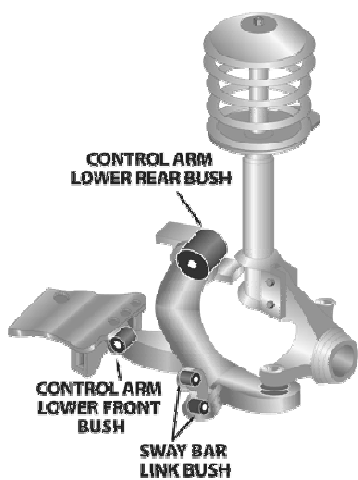



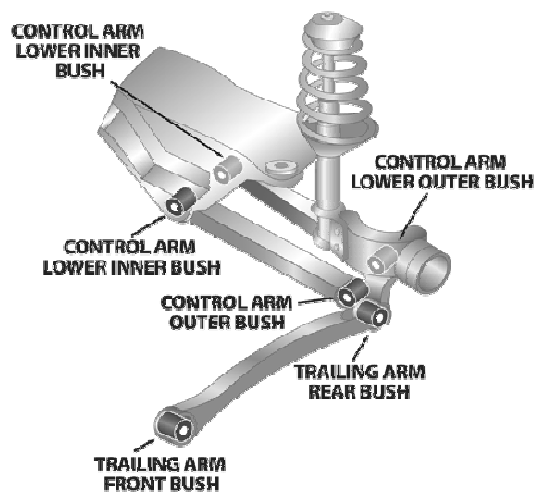
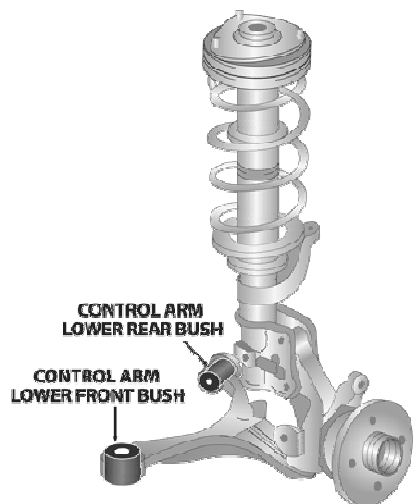

Aplicaci...	Descripción	Referencia	Kits por...	Contenido del Kit	
DEL.	Engine Mount Left Void Filler Insert into original rubber part 12372-0M040	<b>MPU-3215K</b>	1	Bushings	
DEL.	Engine Mount Rear Void Filler Insert into original rubber part 12371-0M030	<b>MPU-3216K</b>	1	Bushings	
DEL.	Engine Mount Right Void Filler	<b>MPU-3217K</b>	1	Bushings	

## TOYOTA Vitz 1st Generation - 2003 - 2007

Página 1



Aplicaci...	Descripción	Referencia	Kits por...	Contenido del Kit	
DEL.	Engine Mount Left Void Filler Insert into original rubber part 12372-0M040	MPU-3215K	1	Bushings	
DEL.	Engine Mount Rear Void Filler Insert into original rubber part 12371-0M030	MPU-3216K	1	Bushings	
DEL.	Engine Mount Right Void Filler	MPU-3217K	1	Bushings	





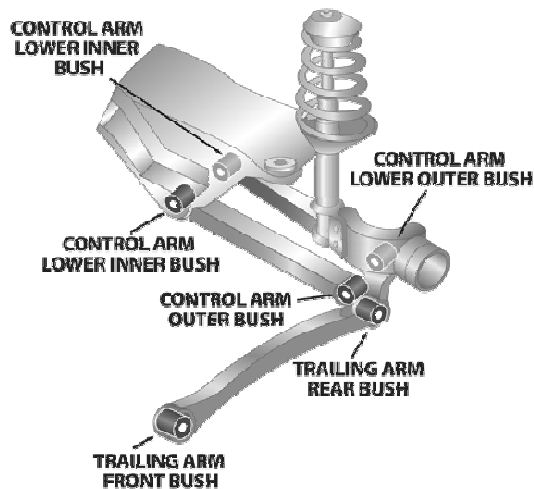
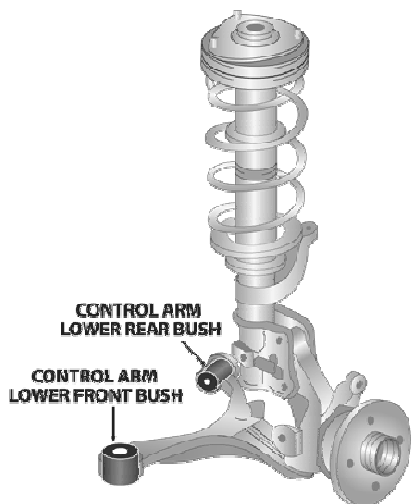

**TOYOTA Prius NHW20R - 10/2003 - 4/2009**

Página 1





Aplicaci...	Descripción	Referencia	Kits por...	Contenido del Kit	
DEL.	Steering Rack & Pinion Mount Bushing Suits rack with OE# 45510-47010 & 45510-47011	<b>MPU-3405K</b>	1	Inner Tubes, Bushings	
DEL.	Steering Rack & Pinion Shaft Guide.....Bush Kit Specialist required for fitment.	<b>MPU-3425K</b>	1	Bushings	

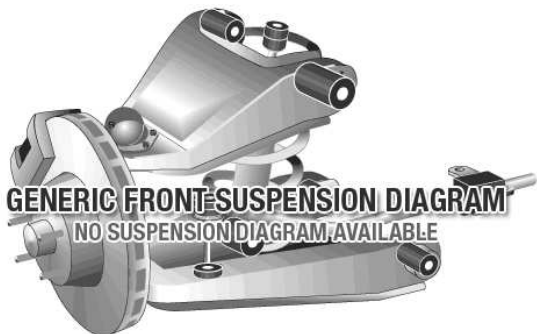

**TOYOTA Prius ZVW30R, 5/2009 - Current -**

Página 1









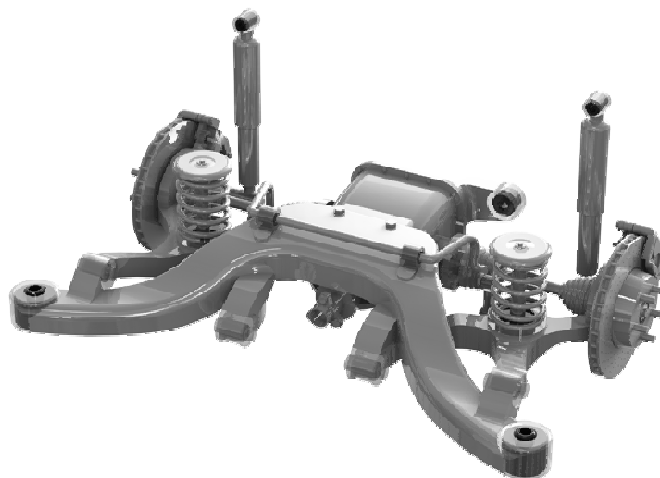
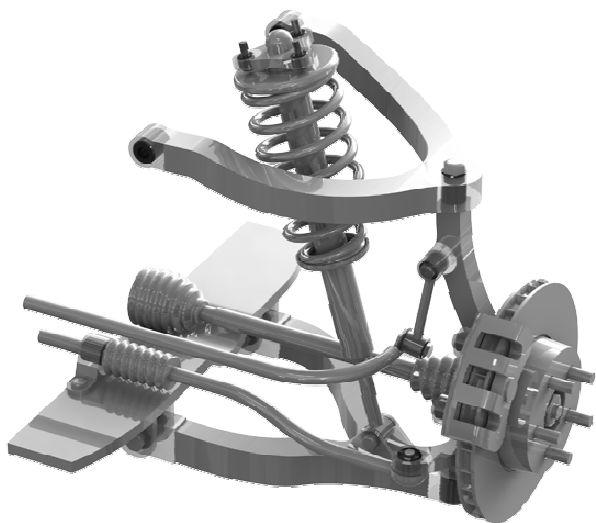

Aplicaci...	Descripción	Referencia	Kits por...	Contenido del Kit	
DEL.	Sway Bar Mount To Chassis Bushing Available sizes - 22.2, 23.4,24,25.4mm	<b>MPU-3719-__K</b>	1	Bushings	



## TOYOTA Mark X X120 Platform - 2004 - 2009

Página 1

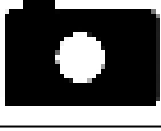







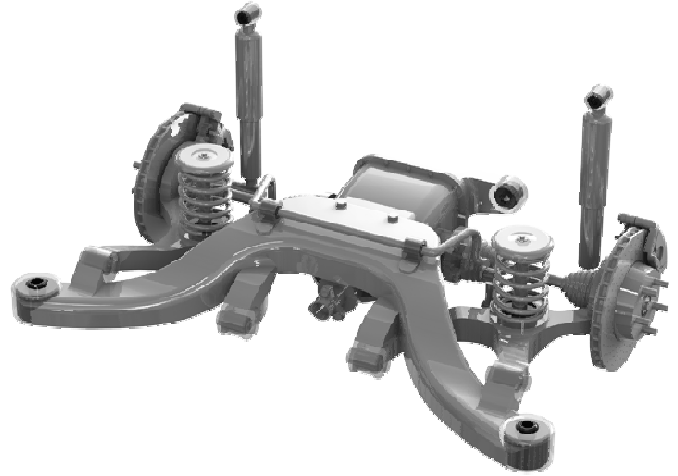
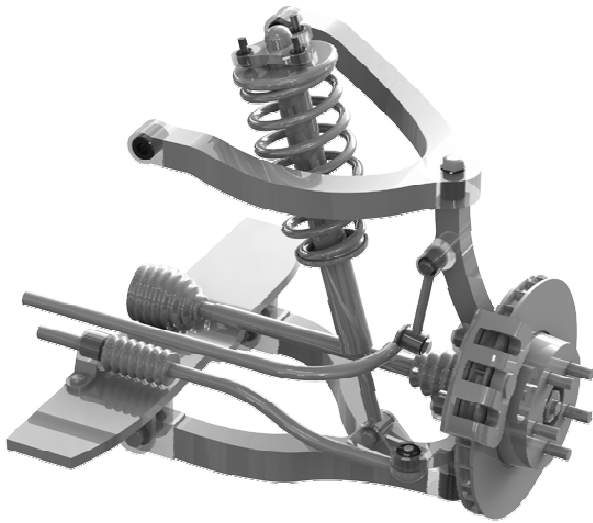

Aplicaci...	Descripción	Referencia	Kits por...	Contenido del Kit	
DEL.	Control Arm Lower Rear Bushing Standard.	<b>MPU-3491K</b>	1	Outer Shells, Inner Tubes, Bushings	
DEL.	Control Arm Lower Rear Bushing Single Offset.	<b>MPU-3675K</b>	1	Outer Shells, Inner Tubes, Bushings	
DEL.	Control Arm Lower Rear Bushing Double Offset.	<b>MPU-3692K</b>	1	Outer Shells, Inner Tubes, Bushings	
DEL.	Control Arm Lower Rear Bushing H/DUTY KIT FOR TRACK USE ONLY	<b>MPU-3491-90K</b>	1	Outer Shells, Inner Tubes, Bushings	
DEL.	Control Arm Lower Rear Bushing (Eccentric) Double Offset.	<b>MPU-3692-90K</b>	1	Inst Sheet, Outer Shells, Inner Tubes, Bushings	
DEL.	Control Arm Upper-Inner Bushing	<b>MPU-3507K</b>	1	Outer Shells, Inner Tubes, Bushings	
DEL.	Control Arm Upper-Inner Eccentric Kit Offset.	<b>MPU-3507XK</b>	1	Inst Sheet, Outer Shells, Inner Tubes, Bushings	



## TOYOTA Mark X X120 Platform - 2004 - 2009

Página 2 (Continúa)





Aplicaci...	Descripción	Referencia	Kits por...	Contenido del Kit	
DEL.	Sway Bar Mount To Chassis Bushing Available in sizes - 24, 27, 28, 30 & 32.5mm.	<b>MPU-3584-__K</b>	1	Bushings	
TRAS.	Control Arm Lower-Inner Bushing	<b>MPU-3508K</b>	1	Outer Shells, Inner Tubes, Bushings	
TRAS.	Control Arm Upper-Inner Bushing	<b>MPU-3505K</b>	1	Inner Tubes, Bushings	
TRAS.	Sway Bar Mount To Chassis Bushing Available in sizes - 14, 15, 17, 18 & 19mm.	<b>MPU-3494-__K</b>	1	Bushings	
TRAS.	Toe Control Arm - Inner Bushing	<b>MPU-3506K</b>	1	Inner Tubes, Bushings	
TRAS.	Trailing Arm Lower Front Bushing	<b>MPU-3503K</b>	1	Inner Tubes, Bushings	
TRAS.	Trailing Arm Upper Front Bushing	<b>MPU-3504K</b>	1	Inner Tubes, Bushings	

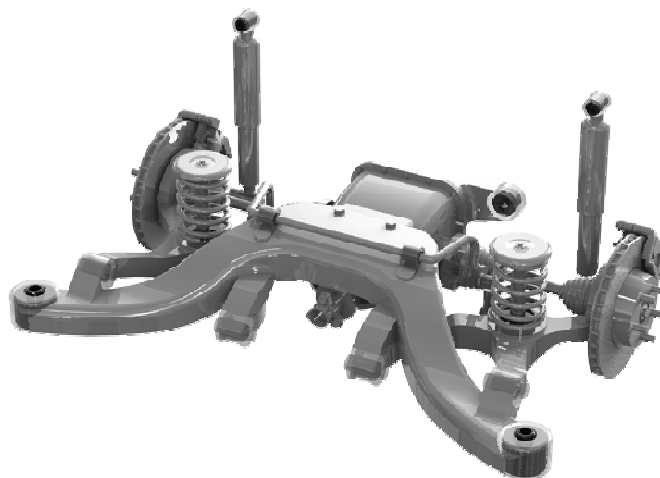
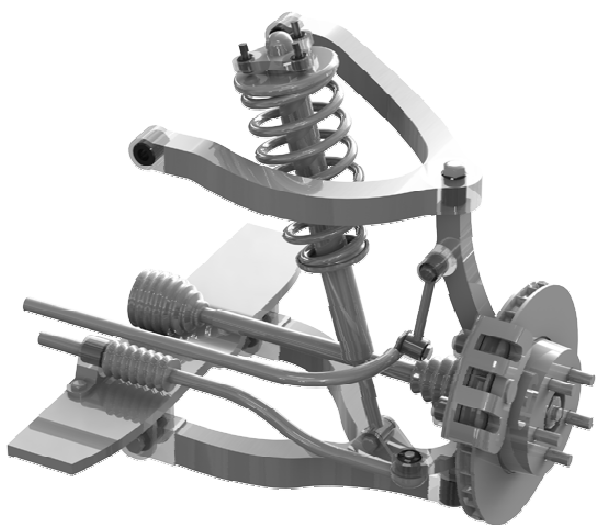

## TOYOTA Mark X X120 Platform - 2004 - 2009

Página 3 (Continúa)









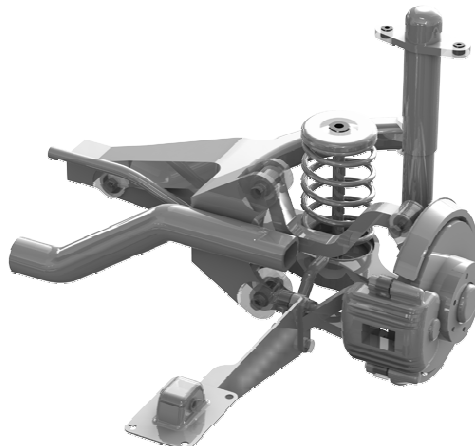
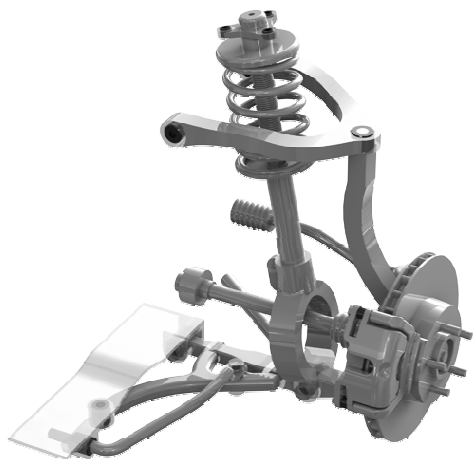

Aplicaci...	Descripción	Referencia	Kits por...	Contenido del Kit	
TRAS.	Trailing Arm Upper Rear Bushing	<b>MPU-3501K</b>	1	Inner Tubes, Bushings	



## TOYOTA Reiz X120 Platform - 2004 - 2009

Página 1









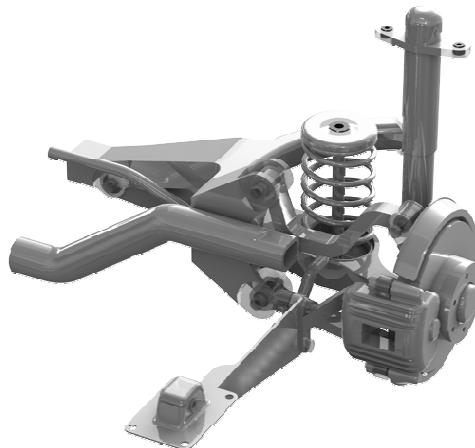
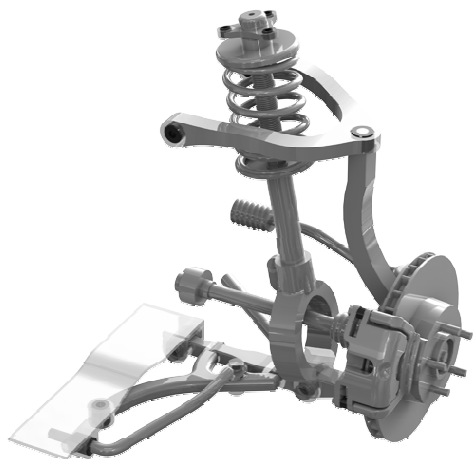

Aplicaci...	Descripción	Referencia	Kits por...	Contenido del Kit	
DEL.	Control Arm Lower Rear Bushing Standard.	<b>MPU-3491K</b>	1	Outer Shells, Inner Tubes, Bushings	
DEL.	Control Arm Lower Rear Bushing Single Offset.	<b>MPU-3675K</b>	1	Outer Shells, Inner Tubes, Bushings	
DEL.	Control Arm Lower Rear Bushing Double Offset.	<b>MPU-3692K</b>	1	Outer Shells, Inner Tubes, Bushings	
DEL.	Control Arm Lower Rear Bushing H/DUTY KIT FOR TRACK USE ONLY	<b>MPU-3491-90K</b>	1	Outer Shells, Inner Tubes, Bushings	
DEL.	Control Arm Lower Rear Bushing (Eccentric) Double Offset.	<b>MPU-3692-90K</b>	1	Inst Sheet, Outer Shells, Inner Tubes, Bushings	
DEL.	Control Arm Lower-Inner Front Kit	<b>MPU-3492K</b>	1	Inner Tubes, Bushings	
DEL.	Control Arm Upper-Inner Bushing	<b>MPU-3507K</b>	1	Outer Shells, Inner Tubes, Bushings	



## TOYOTA Reiz X120 Platform - 2004 - 2009

Página 2 (Continúa)





Aplicaci...	Descripción	Referencia	Kits por...	Contenido del Kit	
DEL.	Sway Bar Mount To Chassis Bushing Available in sizes - 24, 27, 28, 30 & 32.5mm.	<b>MPU-3584-__K</b>	1	Bushings	
TRAS.	Control Arm Lower-Inner Bushing	<b>MPU-3508K</b>	1	Outer Shells, Inner Tubes, Bushings	
TRAS.	Control Arm Upper-Inner Bushing	<b>MPU-3505K</b>	1	Inner Tubes, Bushings	
TRAS.	Sway Bar Mount To Chassis Bushing Available in sizes - 14, 15, 17, 18 & 19mm.	<b>MPU-3494-__K</b>	1	Bushings	
TRAS.	Toe Control Arm - Inner Bushing	<b>MPU-3506K</b>	1	Inner Tubes, Bushings	
TRAS.	Trailing Arm Lower Front Bushing	<b>MPU-3503K</b>	1	Inner Tubes, Bushings	
TRAS.	Trailing Arm Upper Front Bushing	<b>MPU-3504K</b>	1	Inner Tubes, Bushings	

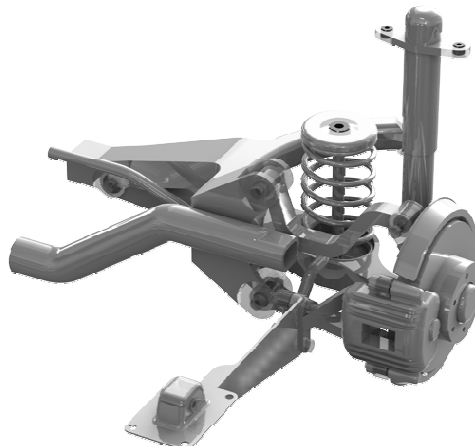
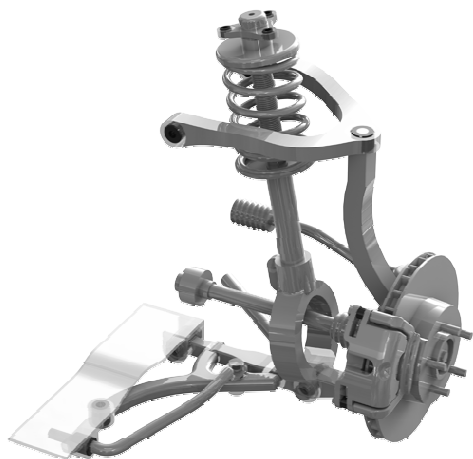

## TOYOTA Reiz X120 Platform - 2004 - 2009

Página 3 (Continúa)



Aplicaci...	Descripción	Referencia	Kits por...	Contenido del Kit	
TRAS.	Trailing Arm Upper Rear Bushing	<b>MPU-3501K</b>	1	Inner Tubes, Bushings	





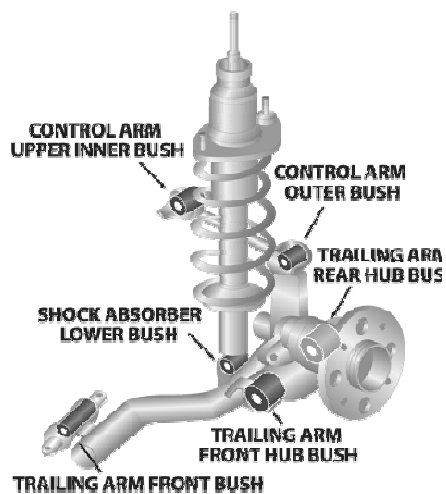
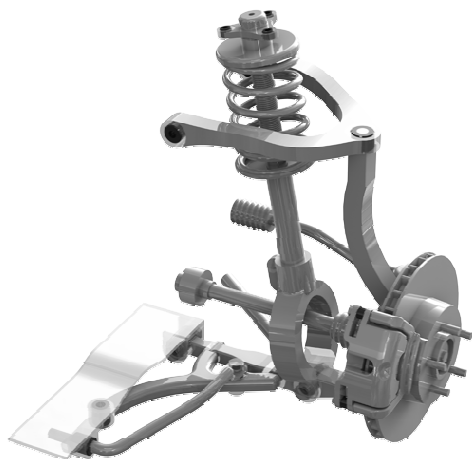

**TOYOTA Avensis ACM20R - 12/01 -**

Página 1



Aplicaci...	Descripción	Referencia	Kits por...	Contenido del Kit	
DEL.	Steering Rack & Pinion Mount Bushing	<b>MPU-3567K</b>	1	Washers, Inner Tubes, Bushings	



**TOYOTA Alphard / Vellfire 2ND GENERATION - 2008 - ON**

Página 1

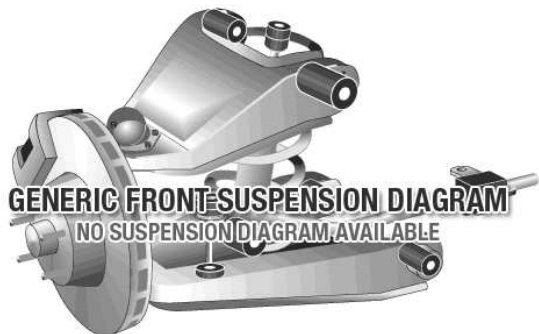

Aplicaci...	Descripción	Referencia	Kits por...	Contenido del Kit	
DEL.	Control Arm Lower-Inner Front Kit O.E# 48654-42040	<b>MPU-3589K</b>	1	Inner Tubes, Bushings	
DEL.	Control Arm Lower-Inner Rear Eccentric DOUBLE OFFSET KIT.	<b>MPU-3867K</b>	1	Outer Shells, Inner Tubes, Bushings	
DEL.	Control Arm Lower-Inner Rear Eccentric SINGLE OFFSET KIT	<b>MPU-3866K</b>	1	Outer Shells, Inner Tubes, Bushings	
DEL.	Control Arm Lower-Inner Rear Kit O.E# 48655-28030	<b>MPU-3588K</b>	1	Outer Shells, Inner Tubes, Bushings	



TOYOTA 86 GT / FT - 2012 - ON

Página 1

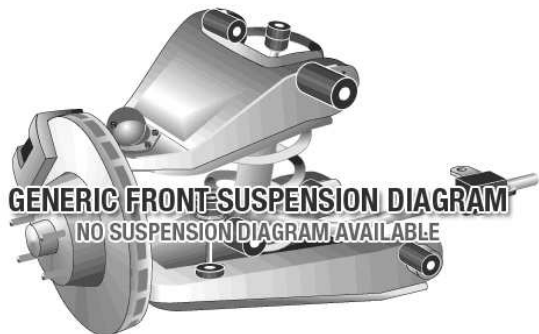

Aplicaci...	Descripción	Referencia	Kits por...	Contenido del Kit	
DEL.	Control Arm Lower-Inner Front & Rear THIS KIT FITS BOTH FRONT & REAR OF THE FRONT LOWER CONTROL ARM	<b>MPU-3877K</b>	1	Outer Shells, Inner Tubes, Bushings	
DEL.	Steering Rack & Pinion Mount Bushing	<b>MPU-3914K</b>	1	Inner Tubes, Bushings	
DEL.	Sway Bar Mount To Chassis Bushing Available sizes	<b>MPU-3868-__K</b>	1	Bushings	
F & R	Vehicle Master Kit CONTENTS - SPF3877K x 1,SPF3914K x 1,SPF3106K x 1,SPF3100K x 1,SPF3907K x 1,SPF3099K x 1,SPF3817K x...	<b>MPK-174K</b>	1	Outer Shells, Inner Tubes, Bushings	
TRAS.	Control Arm Lower-Inner Bushing	<b>MPU-3106K</b>	1	Inst Sheet, Inner Tubes, Bushings	
TRAS.	Control Arm Upper-Inner Eccentric Kit Offset tubes for adjustment	<b>MPU-3101K</b>	1	Inst Sheet, Inner Tubes, Bushings	
TRAS.	Control Arm Upper-Inner Kit	<b>MPU-3100K</b>	1	Inst Sheet, Inner Tubes, Bushings	



TOYOTA 86 GT / FT - 2012 - ON

Página 2 (Continúa)

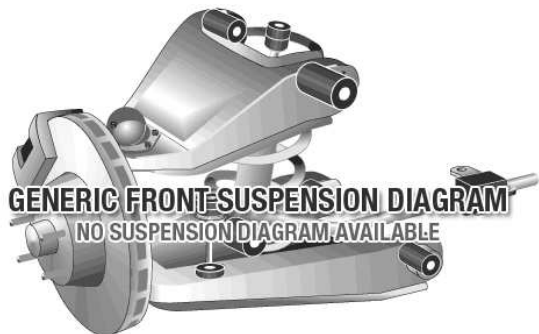





Aplicaci...	Descripción	Referencia	Kits por...	Contenido del Kit	
TRAS.	Crossmember Insert Enhancement Kit INCLUDES UPPER & LOWER INSERTS	<b>MPU-3907K</b>	1	Bushings	
TRAS.	Differential to Subframe Mount Kit Road use.	<b>MPU-4112-80K</b>	1	Inner Tubes, Bushings, Inst Sheet	
TRAS.	Differential to Subframe Mount Kit Competition use.	<b>MPU-4112-90K</b>	1	Inst Sheet, Inner Tubes, Bushings	
TRAS.	Subframe to Chassis Mount Bush Kit	<b>MPU-3818K</b>	1	Washers, Inner Tubes, Bushings	
TRAS.	Sway Bar Link Complete Rod.....OE Replacement	<b>MPU-3915K</b>	1	Link Rod, Inner Tubes, Bushings	
TRAS.	Sway Bar Mount Bushing Measure bar diameter	<b>MPU-3108-__K</b>	1	Bushings	
TRAS.	Toe Control Arm - Inner Bushing	<b>MPU-3099K</b>	1	Inner Tubes, Bushings	

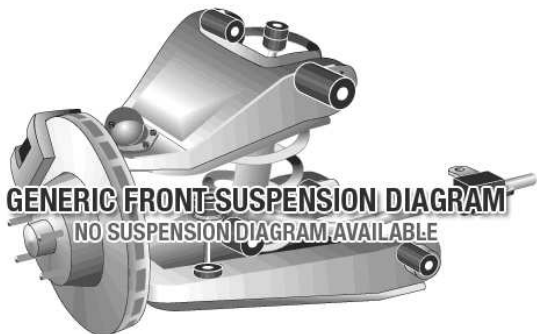

TOYOTA 86 GT / FT - 2012 - ON

Página 3 (Continúa)









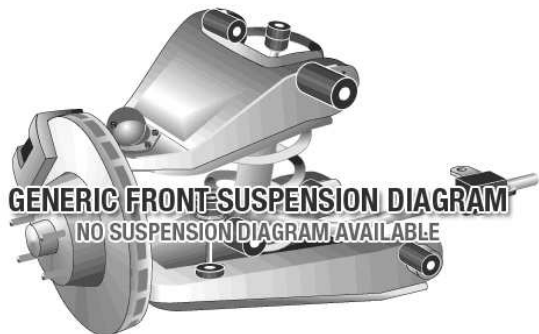

Aplicaci...	Descripción	Referencia	Kits por...	Contenido del Kit	
TRAS.	Trailing Arm - Front Bushing	<b>MPU-3817K</b>	1	Inner Tubes, Bushings	
TRAS.	Trailing Arm - Rear Bushing	<b>MPU-3098K</b>	1	Inst Sheet, Inner Tubes, Bushings	



## INFINITI Infiniti G P10 (First Gen. - G20) - 1991 - 1996

Página 1





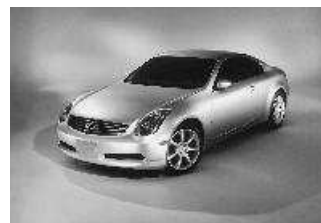





Aplicaci...	Descripción	Referencia	Kits por...	Contenido del Kit	
DEL.	Control Arm Lower Rear Bushing Standard setting.	<b>MPU-1338K</b>	1	Bushings	
DEL.	Control Arm Lower Rear Bushing 1 x Offset 1 x Standard bushing, to adjust caster settings.	<b>MPU-1339K</b>	1	Bushings	
DEL.	Control Arm Lower Rear Bushing 2 x Offset bushings; PS increased DS decrease caster.	<b>MPU-1340K</b>	1	Bushings	
DEL.	Control Arm Lower Rear Bushing 2 x Offset bushings; Increase positive caster both sides.	<b>MPU-1340AK</b>	1	Bushings	
DEL.	Control Arm Upper-Inner or Outer..... Eccentric Bushing Adjustable tubes included in kit.	<b>MPU-1381K</b>	1	Inner Tubes, Bushings	
DEL.	Sway Bar Link Bushing Kit	<b>MPU-0903K</b>	1	Bushings	
TRAS.	Beam Axle Pivot Bushing Do not remove original shell as you have to re-use.	<b>MPU-1942K</b>	1	Inner Tubes, Bushings	



## INFINITI Infiniti G G35 (V35, Second Gen.) - 2003 - 2007

Página 1





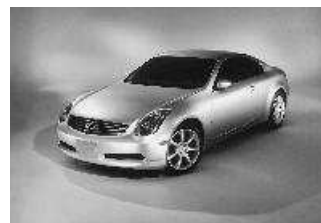



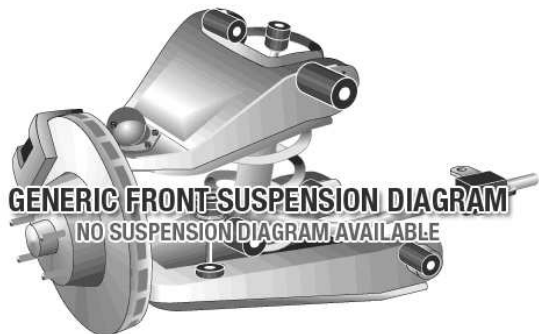

Aplicaci...	Descripción	Referencia	Kits por...	Contenido del Kit	
DEL.	Control Arm Lower-Inner Bushing	<b>MPU-3298K</b>	1	Outer Shells, Inner Tubes, Bushings	
DEL.	Control Arm Upper-Inner Eccentric Kit Offset tubes for +/- camber adjustment, approx 0.5 degree change; Note vehicles with wide...	<b>MPU-3297K</b>	1	Inst Sheet, Inner Tubes, Bushings	
DEL.	Control Arm Upper-Inner Kit Standard replacement.	<b>MPU-3296K</b>	1	Inst Sheet, Inner Tubes, Bushings	
DEL.	Shock Absorber Lower Bushing Bushing located in control arm.	<b>MPU-3299K</b>	1	Outer Shells, Inner Tubes, Bushings	
DEL.	Steering Rack & Pinion Mount Bushing Check tube diameter; This kit suited to 50mm.	<b>MPU-2715-50K</b>	1	Inner Tubes, Bushings	
DEL.	Steering Rack & Pinion Mount Bushing Check tube diameter; This kit suited to 52mm	<b>MPU-2715-52K</b>	1	Inner Tubes, Bushings	
DEL.	Strut Bar To Chassis Mount Kit Standard replacement; Remove original shell for fitment of this kit.	<b>MPU-2847K</b>	1	Inst Sheet, Outer Shells, Inner Tubes, Bushings	 SPF2847K



**INFINITI Infiniti G G35 (V35, Second Gen.) - 2003 - 2007**

Página 2 (Continúa)



Aplicaci...	Descripción	Referencia	Kits por...	Contenido del Kit	
DEL.	Strut Bar To Chassis Mount-Adjustable Bushing 1 x Standard & 1 x Offset bushing; Designed to correct slight pull to left; 0.5 - 0.75 castor...	<b>MPU-2848K</b>	1	Inst Sheet, Outer Shells, Inner Tubes, Bushings	
DEL.	Strut Bar To Chassis Mount-Adjustable Bushing 2 x Offset bushing per kit; Remove original shell for fitment of this kit.	<b>MPU-2849K</b>	1	Inst Sheet, Outer Shells, Inner Tubes, Bushings	
DEL.	Sway Bar Mount Bushing Measure bar diameter, 26,32,34 & 35mm available.	<b>MPU-2359-__K</b>	1	Bushings	
TRAS.	Control Arm Upper-Inner Kit Standard replacement.	<b>MPU-3313K</b>	1	Inst Sheet, Inner Tubes, Bushings	
TRAS.	Camber & Toe Adjusting Kit SPF3321K x 1 & SPF3317K x 1.	<b>MPK-148K</b>	1	Inst Sheet, Outer Shells, Inner Tubes, Bushings	
TRAS.	Control Arm Lower-Front Arm-Inner Kit Standard replacement.	<b>MPU-3316K</b>	1	Outer Shells, Inner Tubes, Bushings	
TRAS.	Control Arm Lower-Front Arm-Outer Kit Bushing mounted in hub.	<b>MPU-3318K</b>	1	Inst Sheet, Outer Shells, Inner Tubes, Bushings	



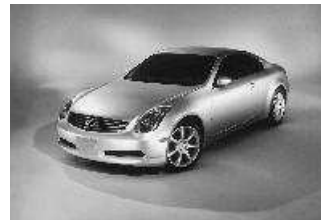





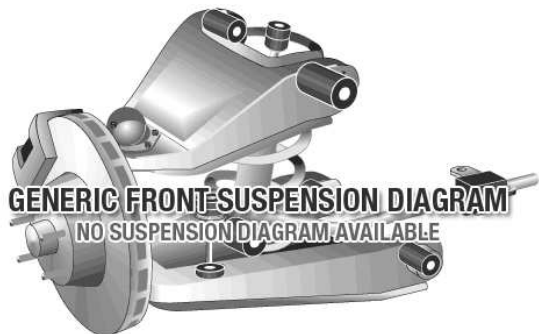

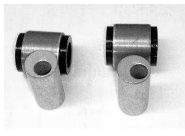

**INFINITI Infiniti G G35 (V35, Second Gen.) - 2003 - 2007**

Página 3 (Continúa)



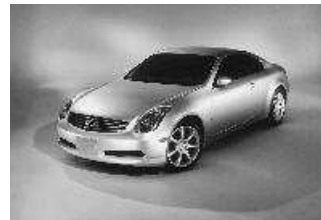

Aplicaci...	Descripción	Referencia	Kits por...	Contenido del Kit	
TRAS.	Control Arm Lower-Inner Front.....Eccentric Offset bushing +/- camber adjustment.	<b>MPU-3317K</b>	1	Inst Sheet, Outer Shells, Inner Tubes, Bushings	
TRAS.	Control Arm Lower-Inner Rear Eccentric Offset tube in kit for +/- toe adjustment.	<b>MPU-3321K</b>	1	Inst Sheet, Outer Shells, Inner Tubes, Bushings	
TRAS.	Control Arm Lower-Rear Arm-Inner Kit Standard replacement.	<b>MPU-3320K</b>	1	Outer Shells, Inner Tubes, Bushings	
TRAS.	Control Arm Lower-Rear Arm-Outer Kit Bushing mounted in hub.	<b>MPU-3322K</b>	1	Inst Sheet, Outer Shells, Inner Tubes, Bushings	
TRAS.	Control Arm Upper-Inner Eccentric Kit Note	<b>MPU-3313XK</b>	1	Inst Sheet, Inner Tubes, Bushings	
TRAS.	Sway Bar Mount Bushing Measure bar diameter 20 & 21mm available.	<b>MPU-3312-__K</b>	1	Bushings	
TRAS.	Trailing Arm - Front Bushing	<b>MPU-3314K</b>	1	Washers, Outer Shells, Inner Tubes, Bushings	

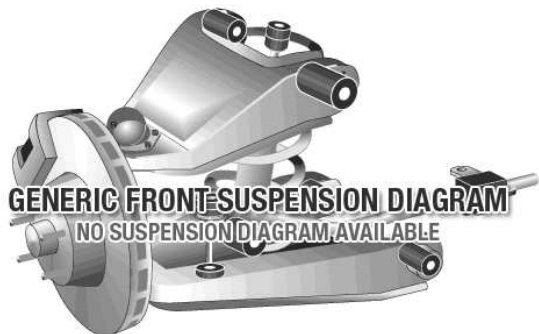

**INFINITI Infiniti G G35 (V35, Second Gen.) - 2003 - 2007**

Página 4 (Continúa)









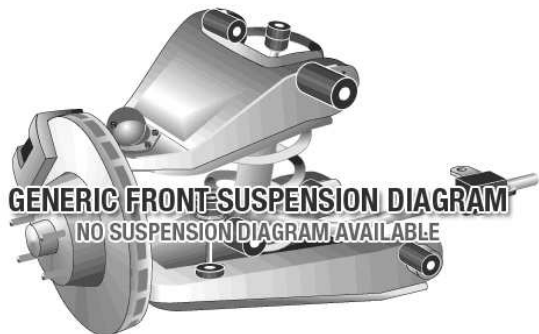

Aplicaci...	Descripción	Referencia	Kits por...	Contenido del Kit	
TRAS.	Trailing Arm - Rear Bushing Bushing mounted in hub.	<b>MPU-3315K</b>	1	Inst Sheet, Outer Shells, Inner Tubes, Bushings	



## INFINITI Infiniti Q45 G50 (First Gen.) - 1990 - 1997

Página 1





Aplicaci...	Descripción	Referencia	Kits por...	Contenido del Kit	
DEL.	Strut Bar To Chassis Mount Kit Standard replacement; 69.5mm long tube; Bracket width 40mm.	<b>MPU-1202K</b>	1	Inner Tubes, Bushings	 SPF1202K
DEL.	Control Arm Upper-Inner / Outer Kit	<b>MPU-0723K</b>	1	Outer Shells, Inner Tubes, Bushings	 0723K
DEL.	Control Arm Upper-Inner / Outer Kit Camber adjusting kit; +/- 1 degree adjustment.	<b>MPU-1659K</b>	1	Outer Shells, Inner Tubes, Bushings	 1659K
DEL.	Strut Bar To Chassis Mount-Adjustable Bushing PS & DS Inc/Dec caster; 69.5 long tube; Bracket width 40mm.	<b>MPU-1202AK</b>	1	Inner Tubes, Bushings	 1202AK
TRAS.	Control Arm Upper-Inner / Outer Kit Standard replacement kit (No Adjustment).	<b>MPU-1638K</b>	1	Inner Tubes, Bushings	 1638K
TRAS.	Control Arm Upper-Inner or Outer..... Eccentric Bushing Inner & outer camber adjustment; 40mm long offset tube.	<b>MPU-1869K</b>	1	Inner Tubes, Bushings	 1869K

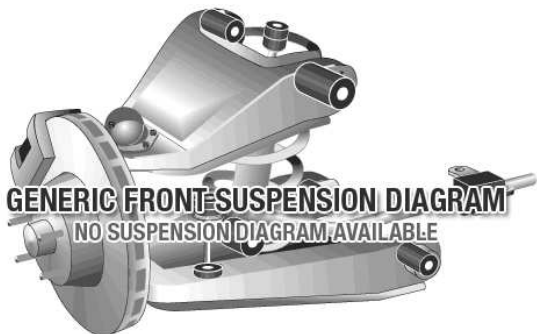

**HUMMER H3 - 07/2007 - 12/2009**

Página 1







Aplicaci...	Descripción	Referencia	Kits por...	Contenido del Kit	
DEL.	Steering Rack & Pinion Mount Bushing TO SUIT RIGHT HAND DRIVE VEHICLE	<b>MPU-3882K</b>	1	Washers, Inner Tubes, Bushings	

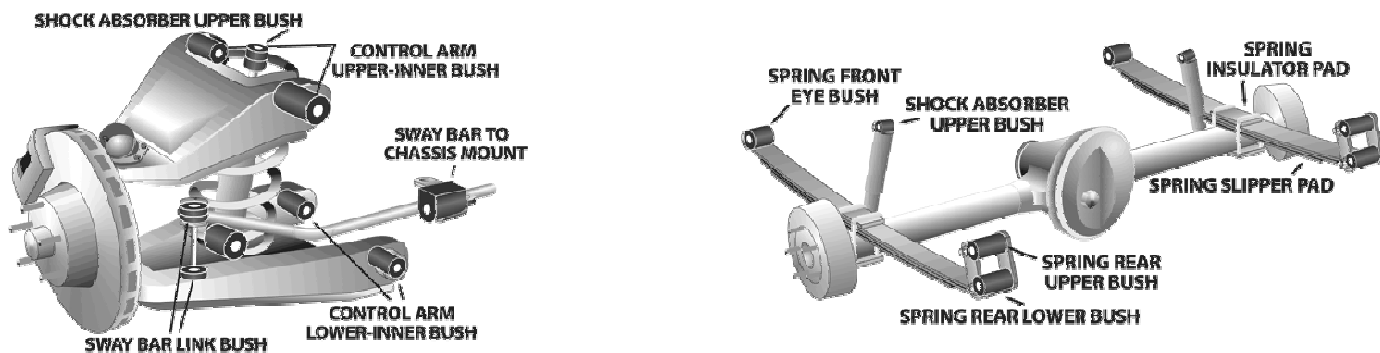

## CHEVROLET Camaro 2 Door Coupe - 1970 - 1981

Página 1









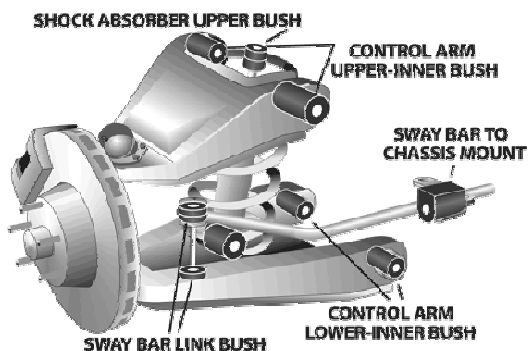

Aplicaci...	Descripción	Referencia	Kits por...	Contenido del Kit	
DEL.	Sway Bar Mount To Chassis Bushing 30mm diameter, Kit includes mounting bracket	<b>MPU-0642-30BK</b>	1	Bushings, Bushings	
DEL.	Sway Bar Mount To Chassis Bushing 32mm diameter with mounting bracket	<b>MPU-0642-32BK</b>	1	Bushings, Bushings	



## CHEVROLET Corvette 2 Door Coupe - 1963 - 1982

Página 1



Aplicaci...	Descripción	Referencia	Kits por...	Contenido del Kit	
DEL.	Shock Absorber Upper Bushing	<b>MPU-2755SK</b>	1	Bushings	
DEL.	Sway Bar Mount To Chassis Bushing Measure bar diameter 14,19,20,22,24,27,28 available	<b>MPU-0248-__K</b>	1	Bushings	
TRAS.	Spring Insulator Pad Bushing Spring cushion retainers at the ends of each leaf spring	<b>MPU-0132K</b>	1	Bushings	
TRAS.	Camber Adjuster Bushing 1972 to 1974 only, Inner & outer bushes	<b>MPU-0993K</b>	1	Inner Tubes, Bushings	
TRAS.	Control Arm Lower-Inner Bushing Must use original crush tube	<b>MPU-0285K</b>	1	Bushings	
TRAS.	Diff to Cross-member to Chassis Kit	<b>MPU-0416K</b>	1	Bushings	



## CHEVROLET Corvette 2 Door Coupe - 1984 - 1990

Página 1

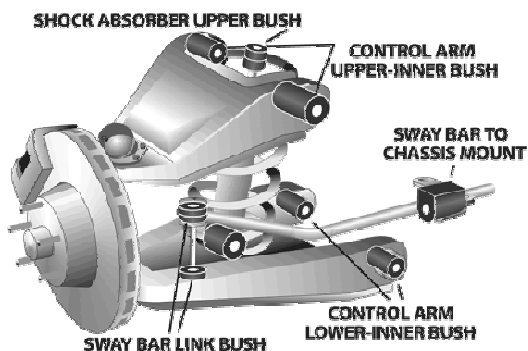



Aplicaci...	Descripción	Referencia	Kits por...	Contenido del Kit	
DEL.	Control Arm Lower-Inner Bushing	<b>MPU-0458K</b>	1	Inner Tubes, Bushings	
DEL.	Control Arm Upper-Inner Front Bushing	<b>MPU-0460K</b>	1	Washers, Inner Tubes, Bushings	
DEL.	Control Arm Upper-Inner Rear Kit	<b>MPU-0459K</b>	1	Washers, Inner Tubes, Bushings	
DEL.	Sway Bar Link Bushing Kit	<b>MPU-0457K</b>	1	Bushings, Inner Tubes	
DEL.	Sway Bar Mount To Chassis Bushing Measure bar diameter 24,26mm available	<b>MPU-0483-__K</b>	1	Bushings	
TRAS.	Control Arm-Bush Kit	<b>MPU-0461K</b>	1	Bushings	
TRAS.	Trailing Arm - Front Bushing	<b>MPU-0456K</b>	2	Bushings, Inner Tubes	

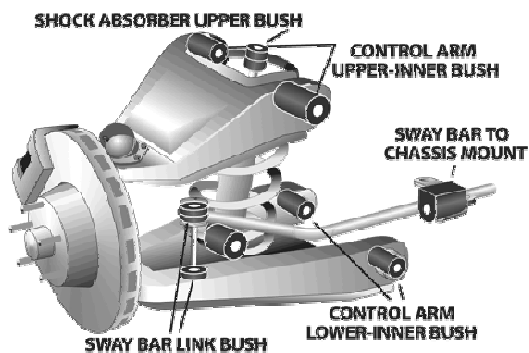

## CHEVROLET Corvette 2 Door Coupe - 1984 - 1990

Página 2 (Continúa)



Aplicaci...	Descripción	Referencia	Kits por...	Contenido del Kit	
TRAS.	Trailing Arm - Rear Bushing	MPU-0455K	2	Inner Tubes, Bushings	





## CHEVROLET Impala Sedan - 1965 - 1970

Página 1

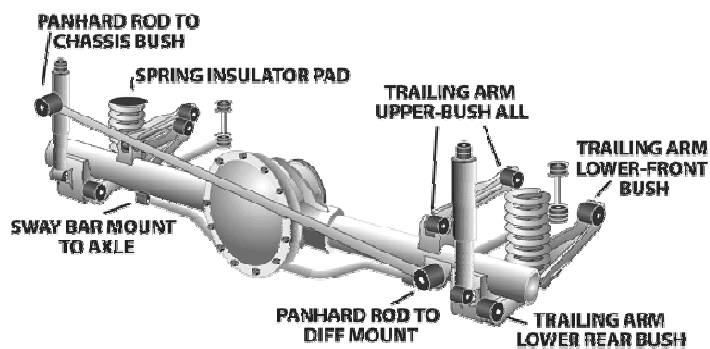
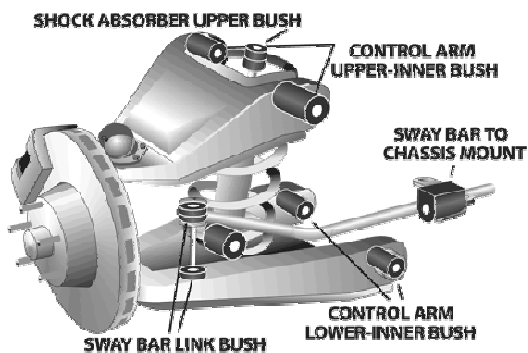



Aplicaci...	Descripción	Referencia	Kits por...	Contenido del Kit	
DEL.	Strut Bar To Chassis Mount Kit	<b>MPU-0133K</b>	1	Bushings	
DEL.	Sway Bar Link Bushing Kit	<b>MPU-2092BK</b>	1	Bushings	
DEL.	Sway Bar Mount To Chassis Bushing 24mm bar, Square shape bush	<b>MPU-0284K</b>	1	Bushings	

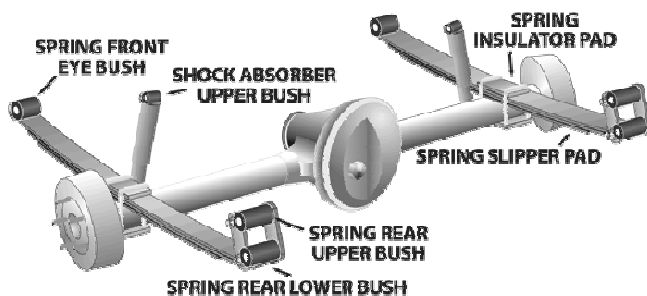
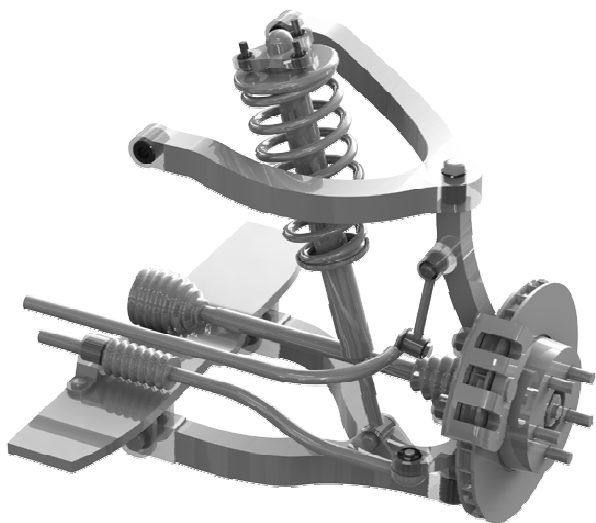

CHEVROLET Tacuma Sedan & Wagon - 11/2000 - 2005

Página 1





Aplicaci...	Descripción	Referencia	Kits por...	Contenido del Kit	
DEL.	Sway Bar Mount Bushing Measure bar diameter 19.5,22mm available,OE bracket # 96444468	MPU-2655-__K	1	Bushings	

## CHEVROLET C1500 Pick up C1500 - 1996 - 2004

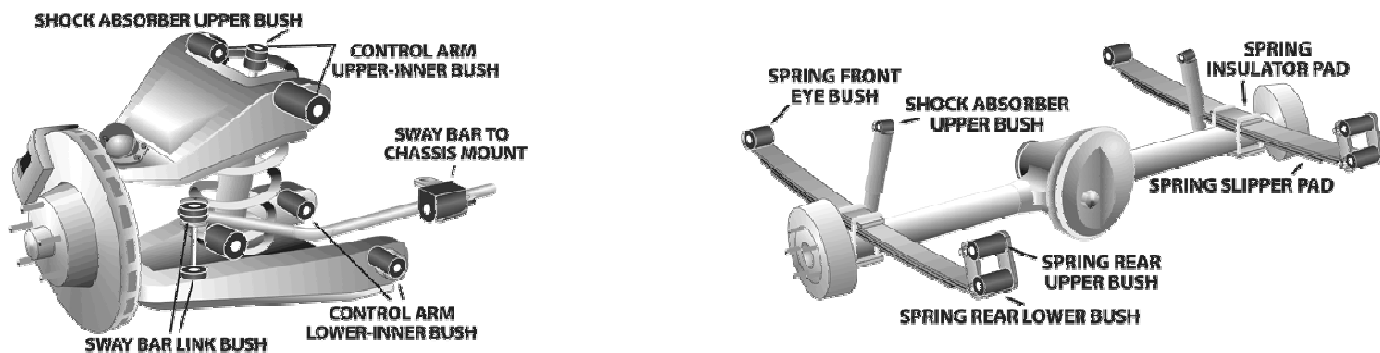
Página 1







Aplicaci...	Descripción	Referencia	Kits por...	Contenido del Kit	
DEL.	Sway Bar Mount Bushing Measure bar diameter as 31,33 & 36mm are available. Replaces OE numbers 88912396 or 88912397	MPU-2936-__K	1	Bushings	

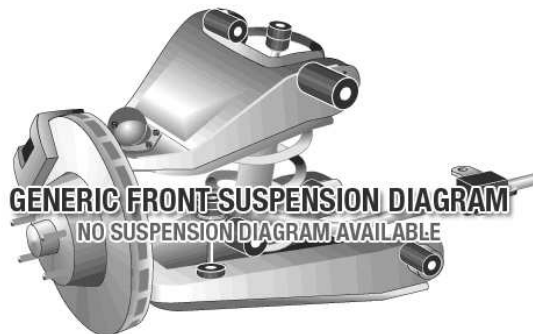
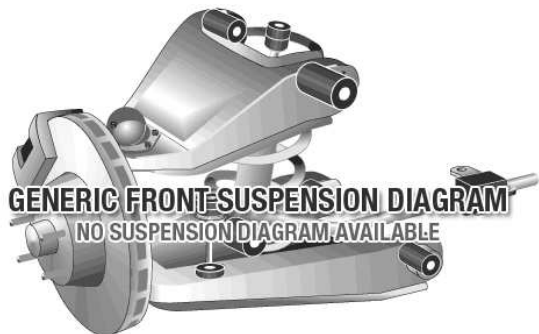

## CHEVROLET Colorado RG (Thailand) - 2012 - On

Página 1



Aplicaci...	Descripción	Referencia	Kits por...	Contenido del Kit	
TRAS.	Spring Front Eye Bushing Thai make only	<b>MPU-2670K</b>	1	Inner Tubes, Bushings	
TRAS.	Spring Rear Bushing All This kit contains - SPF2231-4K x 1, SPF4040K x 1, SPF2670K x 1 Thai make only	<b>MPK-185K</b>	1	Inner Tubes, Bushings	
TRAS.	Spring Rear Lower Bushing Thai make only	<b>MPU-2231-4K</b>	1	Bushings	
TRAS.	Spring Rear Upper Shackle Bushing Thai make only	<b>MPU-4040K</b>	1	Bushings	